



Powerful HMI/SCADA Software
XGT InfoU

Powerful HMI/SCADA Software

XGT InfoU

Experience XGT InfoU incorporated
with the innovative technologies of LSIS

XGT InfoU of LSIS is an open architecture type HMI/SCADA operating system that demonstrates expandability and compatibility, applied with the customer's requirements including, but not limited to the user-friendly interface, state-of-the-art graphic technology and stable, quick network.

It is a product incorporated with LSIS's innovative technologies, as LSIS developed PLC for the first time in Korea, becoming the frontier company in the automation industry. Unlike other overseas products, it ensures engineering productivity in a wide range of industrial sites from field monitoring panel to process control centers, as the product is capable of satisfying the domestic user requirements – efficiency and general-purpose use.



MAINTENANCE







Feature

Powerful HMI/SCADA Software Incorporated with the State-of-the-Art Graphic Technology

Improves competitiveness using user-friendly technologies
With the latest technology, we leap to the next stage for customers.

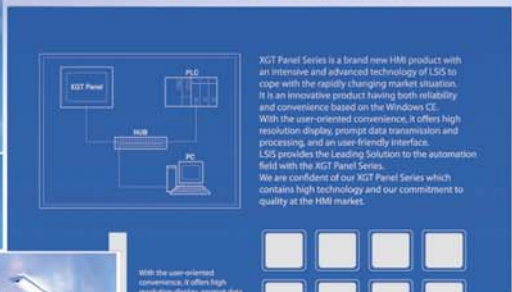

With the user-oriented convenience, it offers high resolution display, prompt data transmission and processing, and an user-friendly interface.



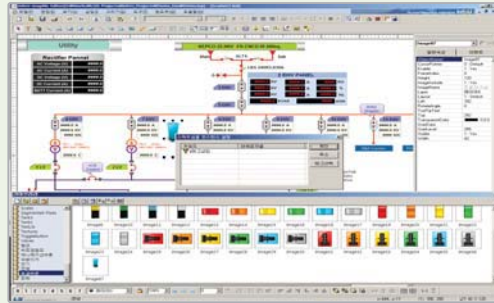

Through intelligent integration with XGT series, automatic tag registration and simulation can be used to easily create and maintain a project. Supports various communication drivers, and when it comes to tag, it supports both the physical layer and group-based logical layer, building a structured tag.

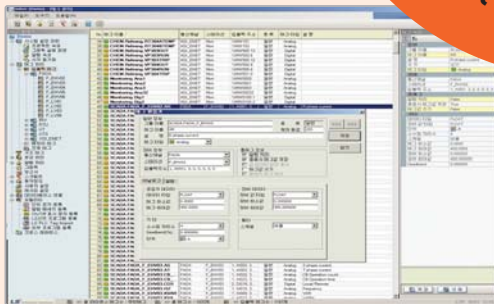
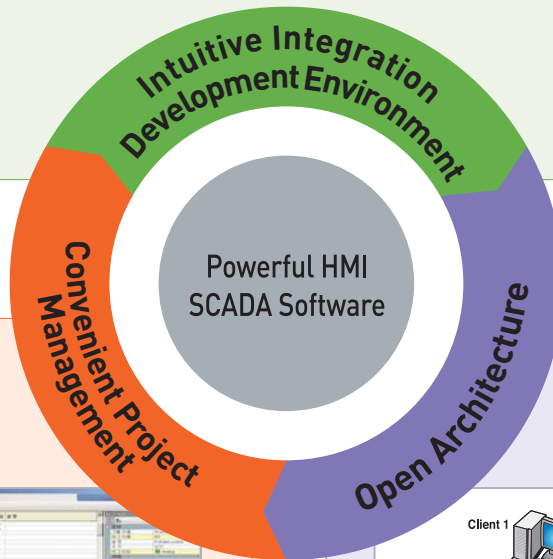

XGT InfoU offers development environment that complies with the UI standards of integrated MS Windows, so that users can easily create and maintain a project. All projects can be managed with a single tool, and work time can be reduced using UI browser classified by function. In addition, several user-friendly functions such as structure tag creation and CSV file support are provided.

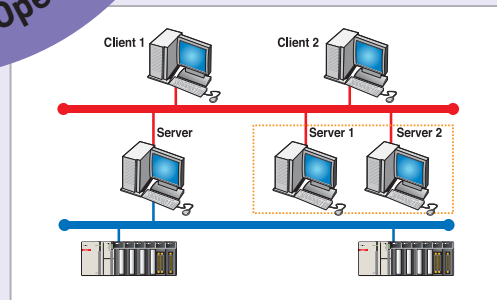

Supports various industrial protocols such as OLE DB and OPC, which enable easy connection with other systems or MES/ERP

- Supports OPC DA Client/ Server.
- OPC DA Server is capable of sorting and selecting the tag to be shared, preventing critical tags to be opened to external applications.
- Using database link function, Oracle/MS SQL server and data can be easily exchanged with tags.
- XGT InfoU supports function of searching and modifying tag/character string.

Outstanding System Architecture

XGT InfoU HMI/SCADA is designed with an excellent program architecture applied with the latest IT, and is fully equipped with stability, convenience and performance.

Process Management

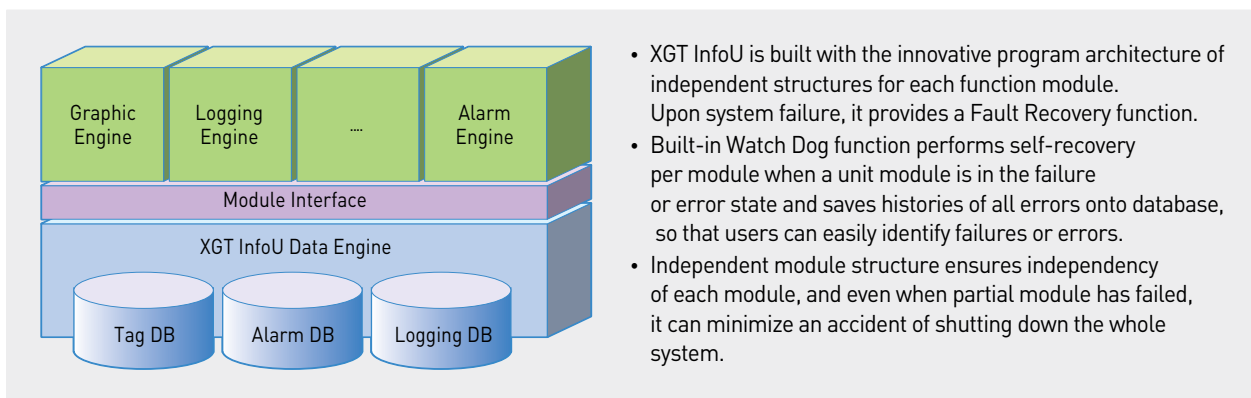

Client/Server Architecture

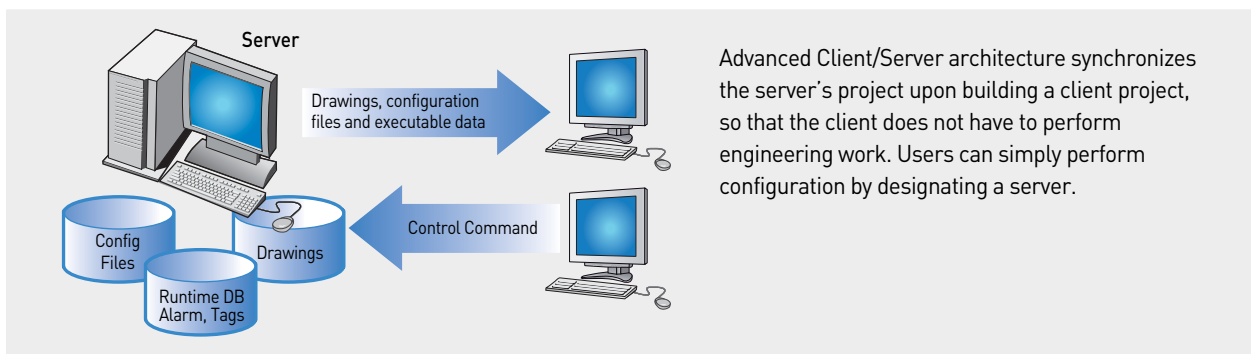

Web/Mobile Service

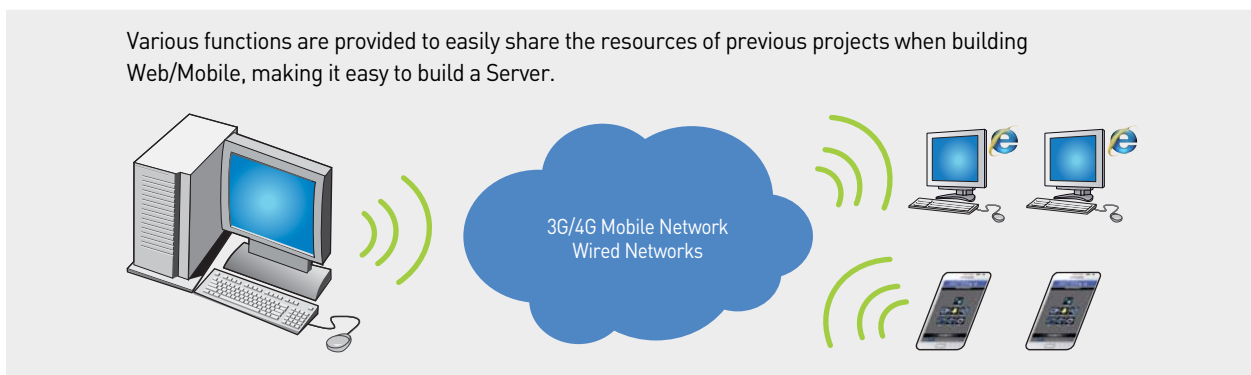

Convenient System Expansion

XGT InfoU that is applicable from field monitoring panels to wide SCADA system can change project attributes in order to expand a single monitoring system to a client/server architecture for previous projects.

Stand-alone System

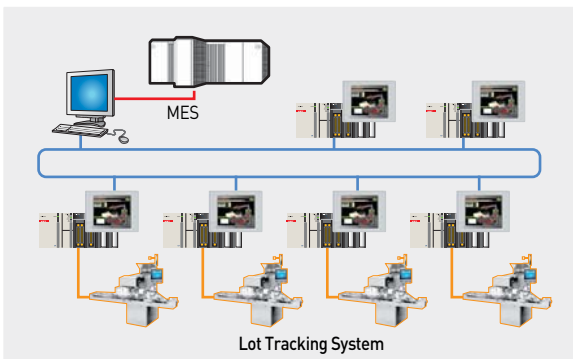

Data of equipments are collected in real time to set a data transmission system that has the role of operators to comprehensively monitor and analyze operation status. Acts as a central master supervisor to execute a Real Time Monitoring function of field data. Basic information such as Down Time calculation of devices is provided to easily record operational data.

Wireless System

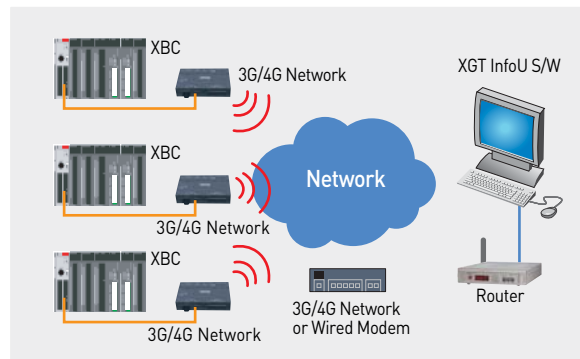

Using an exclusive 3G/4G Network Gateway driver that supports mobile networks, users can conveniently build Wireless Systems.

SCADA System

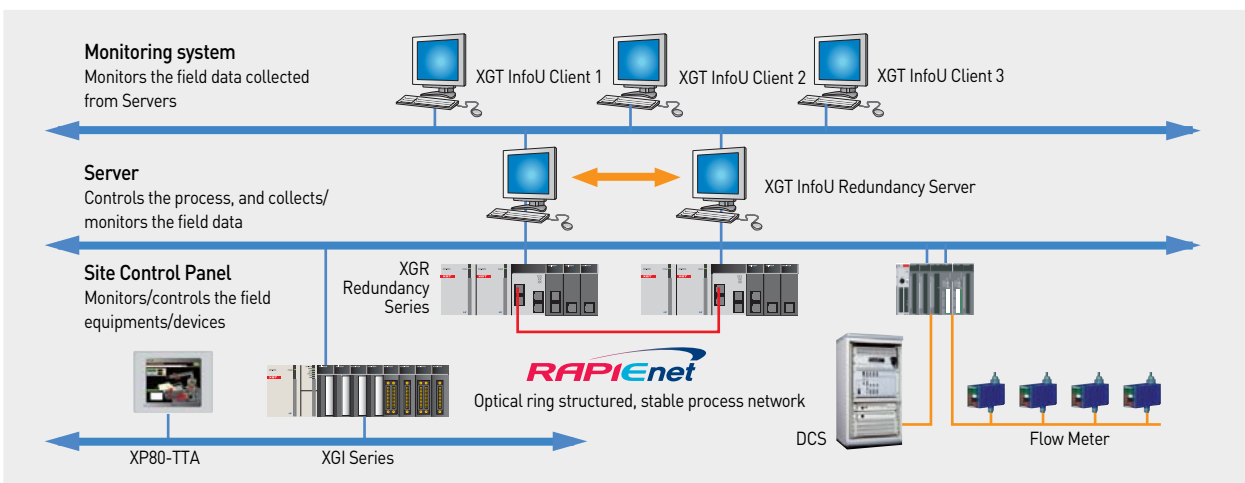

- Field/site devices scattered in a remote place can be collected via an efficient network, and a wide range of alarm information can be managed.
- Using SOE module, site trip data are synchronized so as to analyze the cause(s) of an accident accurately.
- Using database link and operation function, tag values can be input/output at general database such as MS SQL and ORACLE, and efficient data sharing with MES or ERP system is possible.

Expansible System Configuration

XGT InfoU Mobile supports Android devices and monitors the site at any place that user wants



- Screens can be created using a mobile graphic editor.
- Includes a tag monitoring function, user group overview function and alarm monitoring function.
- Clients that run in Android environments are provided.

※ Client App can be downloaded from Google Play Store

XGT InfoU Web Server performs an automatic web conversion of the existing project data using a Wizard function.

XGT InfoU supports Dual System for stable system operation.

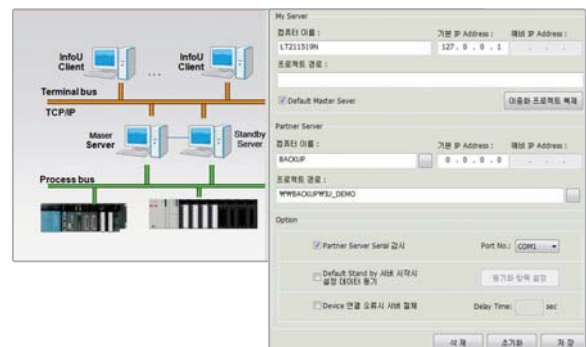
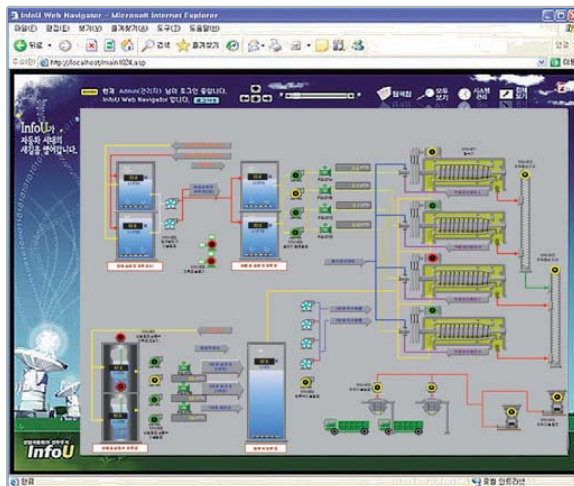

- Users without expertise on configuration of a Web Server or Web Site can easily build it
- Web browser is used for real-time monitoring /control and history data can be monitored through trend.
- New web site can be created and virtual folders can be added to the existing web site for link connection.

- When a Master Server is in failure, it automatically switches to a Standby Server to provide reliable system configuration.
- RS-232C communication line is used to monitor the status of partner servers.
- Manual Switching: Manual switching from the menu and script is possible.
- Supports time synchronization among Server1 - Server2 - Client
- RS-232C communication line is used to monitor the status of partner servers.
- Project Duplication: A project is automatically duplicated to prevent errors providing user convenience.

Various Basic Functions

Special functions used on site are installed to assist users in building HMI.

Minimum 50ms, High-Speed Trend



- Function provided for the system that requires high-speed trend screens such as a tester, and without special equipment or exclusive PLC program, it can be configured using only XGT InfoU.
- Provides templates for users to easily build a system, so even novice users can do so.

Trend Template



- Provides various Trend templates, and users can modify them.
- Trend template files are in "InfoU/bin/GraSys" directory.

Alarm Viewer

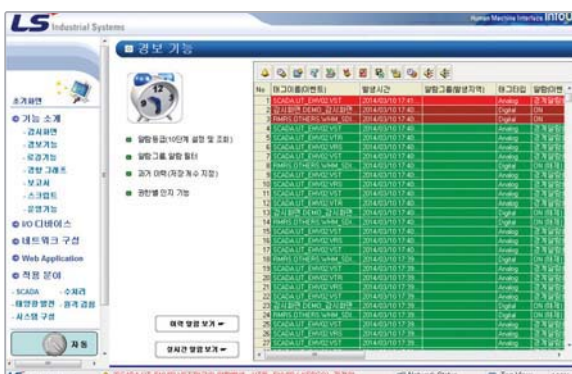

- Provides Alarm history records from server, searching records with filters and printing it to CSV file.
- Provides notification message to SMS or E-mail.

Database Link

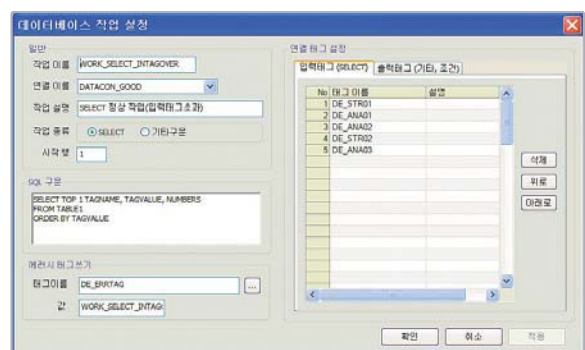

Without using a separate program or script, it uses only basic functions to send the data generated on site to the main Database Server. Thus, any user without the knowledge on Database can build a system.

XGT InfoU SCADA System

SCADA System is an abbreviation for “Supervisory Control And Data Acquisition System”, which is also referred to as the “Centralized Remote Monitoring/Control System”. The required main functions are specified in ANSI (American National Standards Institute) /IEEE(Institutes of Electrical and Electronics Engineers) Std c37.1-1987 as described below.

- ① An alarm function of the monitoring system that perform the predefined operations based on the alarm status of a remote device;
- ② A monitoring/control function that operates the external remote device manually/automatically (optional) or in combination of both;
- ③ An indicator (display) function of the monitoring system that receives, displays and records the information on remote device status;
- ④ An accumulation function that displays and records the information on digital pulse through reception and summation; and
- ⑤ A function to recognize the predefined events and provide the data on generated events.

XGT InfoU SCADA System offers the functions that satisfy the these requirements.

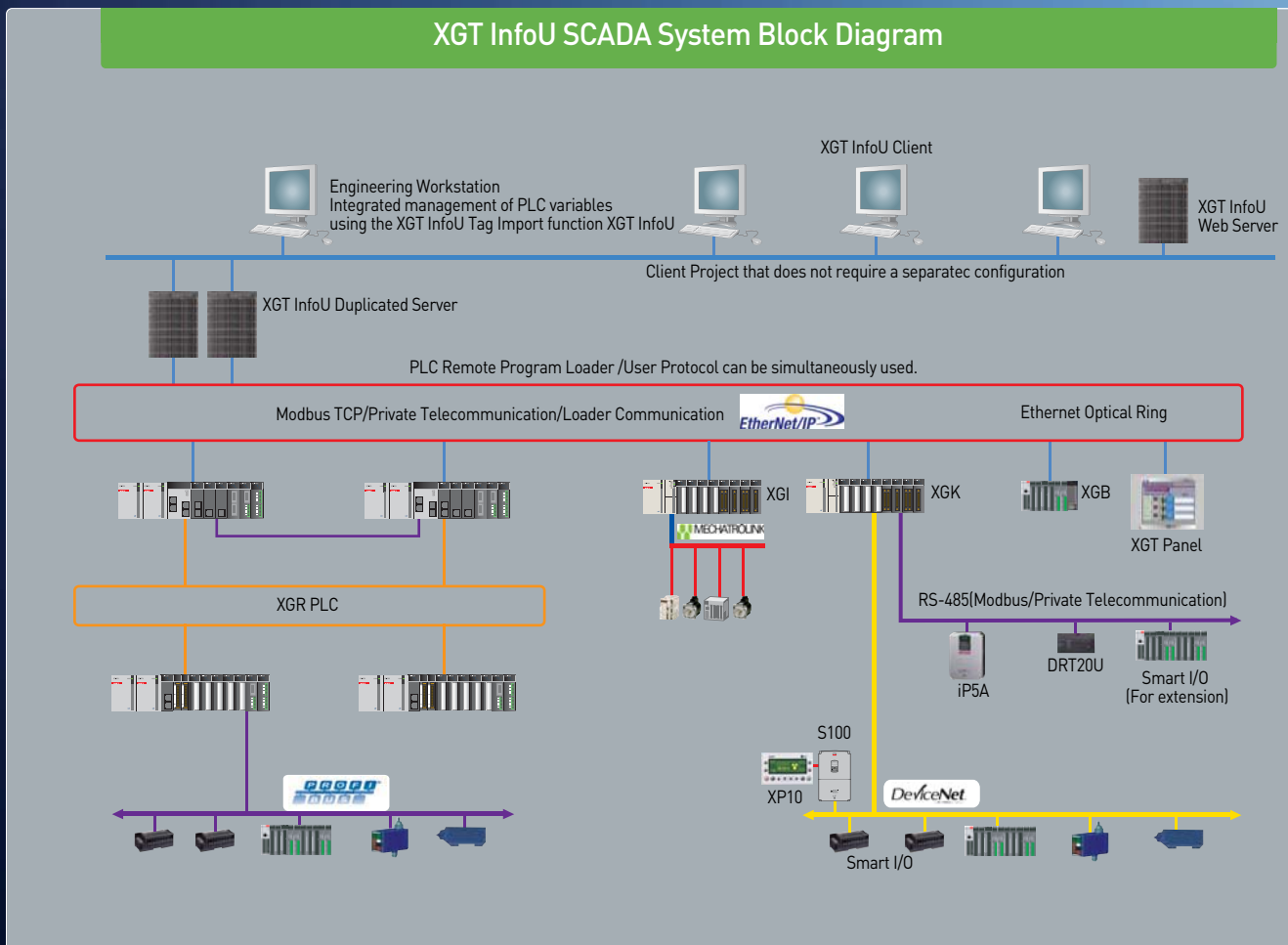



Private-Line based XGT InfoU SCADA System Block Diagram

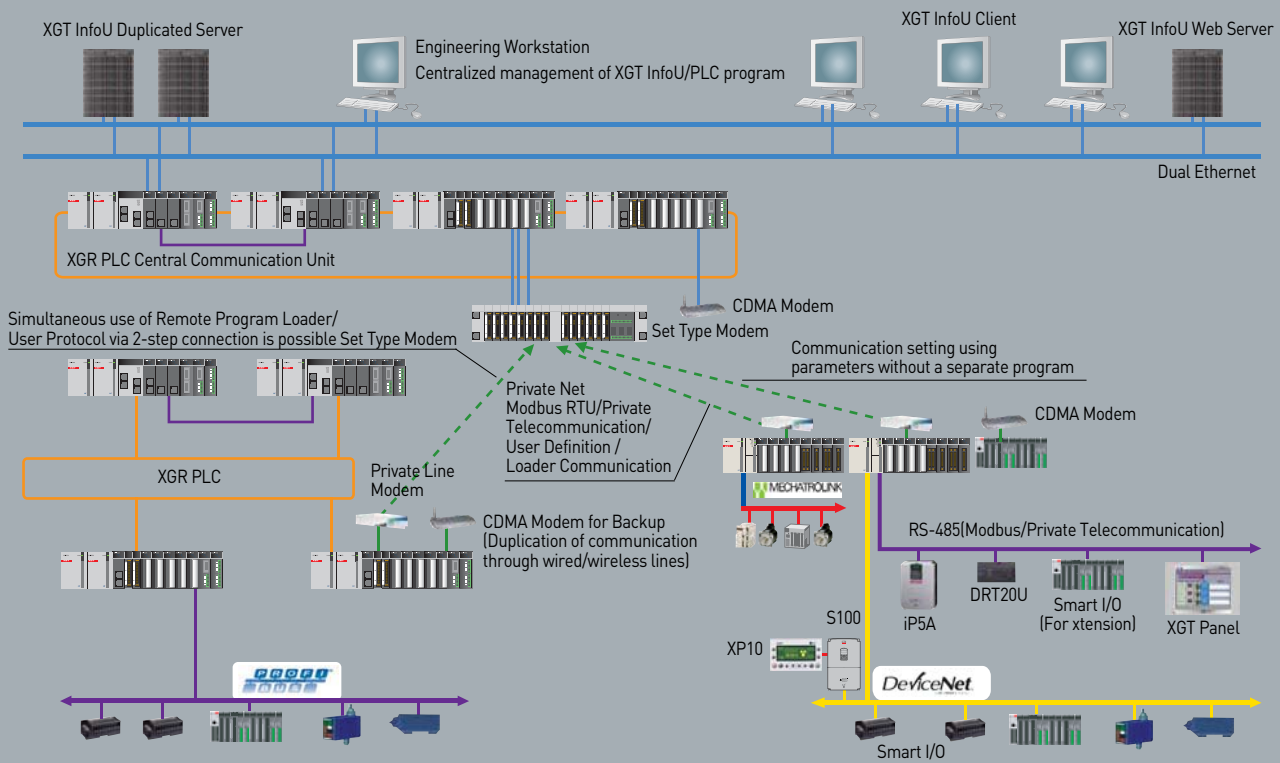

Various Application Cases

Testing Apparatus for Parts

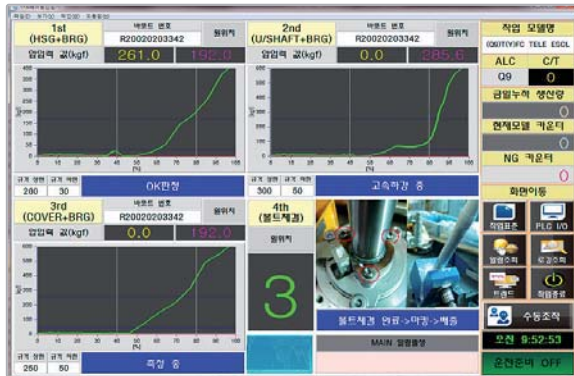

Key Function

- High Speed Data Trend
- Save, inquire and print the data on quality
- Linked to the main DB (EMS)

Metro SCADA System

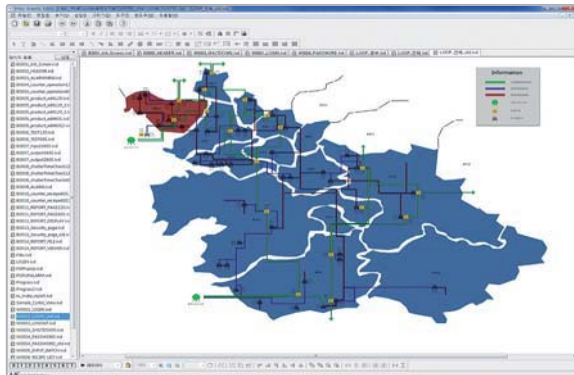

Key Function

- Wide area network management using wires/wireless communication networks
- Notify processing of alarm, SMS and Sound
- Server-Client dual system

Process Monitoring System

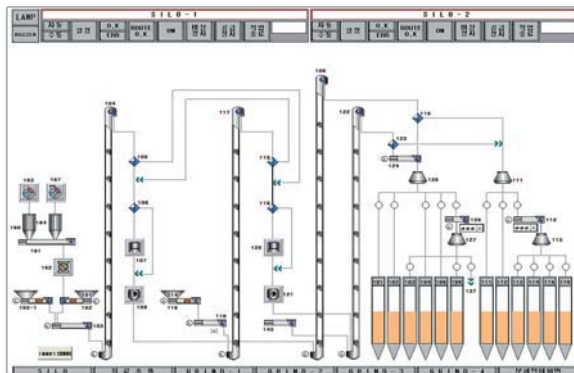

Key Function

- Factory (Plant) and building automation system used
- Schedule control function
- Inquiry of history data, Report and Trend

Facility Monitoring System

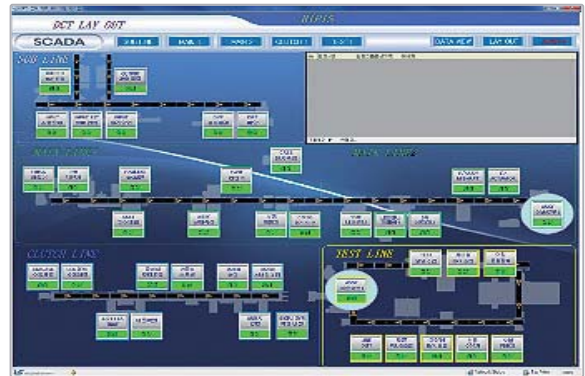

Key Function

- Monitoring the facility status
- Save and inquire the status data to/from the Database
- History Logging, Trend and Report

21 CFR Part 11



Key Function

- User authorization management, and save/ inquire the operation history
- Save the data on quality and status, and report printing (PDF)
- Alarm data management and batch management

Water Treatment System

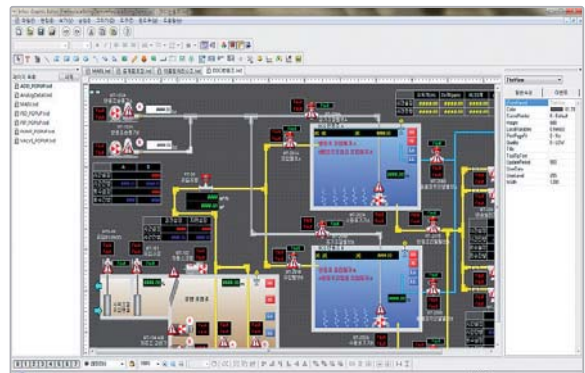

Key Function

- Monitoring data and process of various sensors
- Data Logging, Report, History and Trend
- Web & Mobile

Communication Drivers

XGT InfoU provides a lot of communication drivers including LSIS's PLC and those of many other world-class brands, allowing easy system configuration by users.

※ Main industrial protocol drivers including DNP 3.0 and BACnet/IP are provided.

Various Communication Drivers

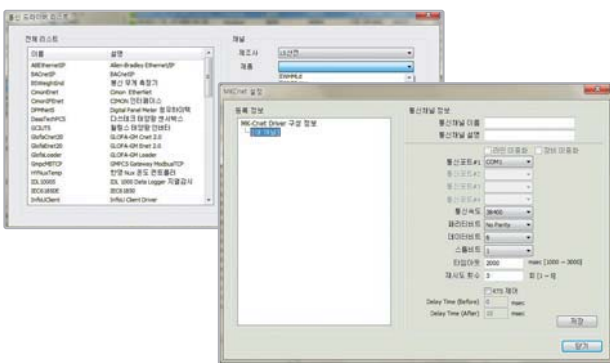

- Offers 50 types of various communication drivers for PLC and Controller.
- Provides user-defined communication drivers for users to directly register protocols/devices.
- Operation status is provided as a system tag and I/O status can be displayed on screen.
- Provides industrial standard protocol drivers such as BACnet/IP, DNP 3.0 and IEC61850.
- Provides drivers to XGT InfoU for FEP configuration.
- Various communications with an OPC Server via an OPC client driver.

Dynamic IP Address

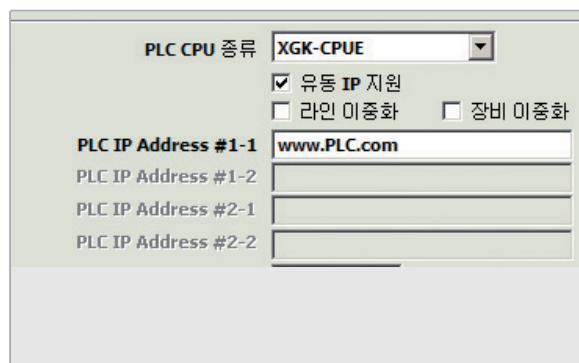

- Supports Dynamic IP using DDNS service to assist system development using site Dynamic IP.
- Users can build remote communication without costly fixed IP.

User Defined Protocol Driver

번호	형태	크기	데이터	명령어	설명
0	변지명 상수	0	LSIS-XGT		회사이름
1	수치 상수	2	00 00		Reserved
2	수치 상수	2	00 00		PLC Info
3	수치 상수	1	A0		CPU Info
4	수치 상수	1	33		Source of Frame
5	수치 상수	2	12 34		Invoke ID
6	수치 상수	2	10 00		Instruction의 Byte 크기
7	수치 상수	1	00		FENet Position
8	비트	1	BYTE SUM		
9	수치 상수	2	54 00		Command
10	수치 상수	2	14 00		Data Type
11	수치 상수	2	00 00		Reserved
12	수치 상수	2	01 00		Variable Number
13	수치 상수	2	04 00		시작주소 길이
14	변지명 상수	4	%MB0		시작주소
15	수치 상수	2	78 05		Data Size

- Provides Frame Editor, so users can design own protocol
- Serial driver name is UserDefineS and Ethernet driver name is UserDefineE

XGT InfoU Run-Time Simulation

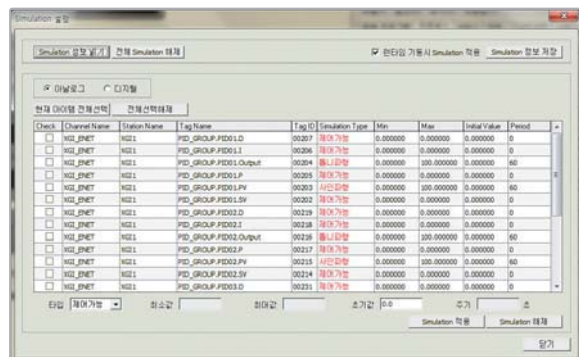

Without a device like PLC, a simulator can be used to create Sin wave, triangular wave and random values, and functions can be checked using a display screen.

Development Environment

Tag Expression

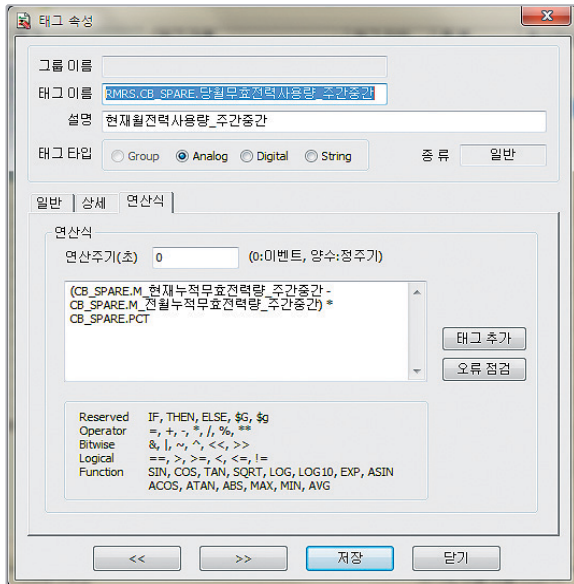

- In XGT InfoU, arithmetic expressions such as four fundamental arithmetic operations, conditional statements and variables can be used to calculate a memory tag.
- In XGT InfoU, a formula is applied to expression attributes of a subject tag which is the result of calculation.
- Upon activation of a data processing engine, it compiles all the expressions included in a tag and calculates by setting each calculation set and priority.
- Thus, users use existing tag values to create a new tag value, without help of PLC or scripts.

Embedded Visual Basic Engine

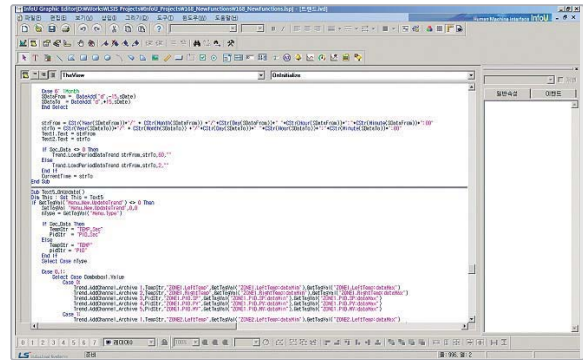

- For implementation of user-defined unique functions, VBS is used to build expanded objects.
- Compatible with existing MS office scripts and pre-defined sources can be reused.
- XGT InfoU's internal functions are provided to easily program at the point of operation.
- Various operation triggers like mouse, events and initialization are provided to easily program at the point of operation.

Tag Expression

- Replaced string can be used on screen as it is listed in a library as template when types like PID controller and pumps repeatedly appear on screen.
- Using the replaced string, a graphic library or screen template containing user attributes can be configured.

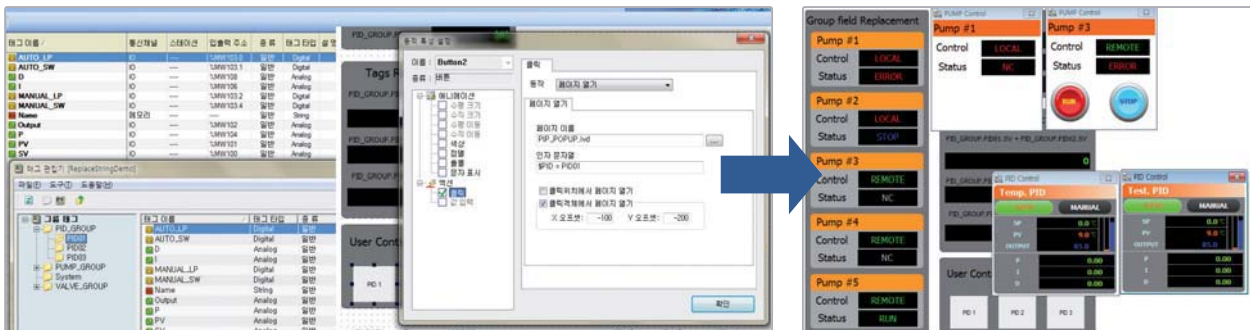

Logging

XGT InfoU supports a wide range of storage methods for easy management of collected data, and uses various graphic objects and integrated reports for users to easily access saved data. XGT InfoU's externally expanded API is used for easier access to saved data from external applications.

Logging Group without a limit to the number of tags

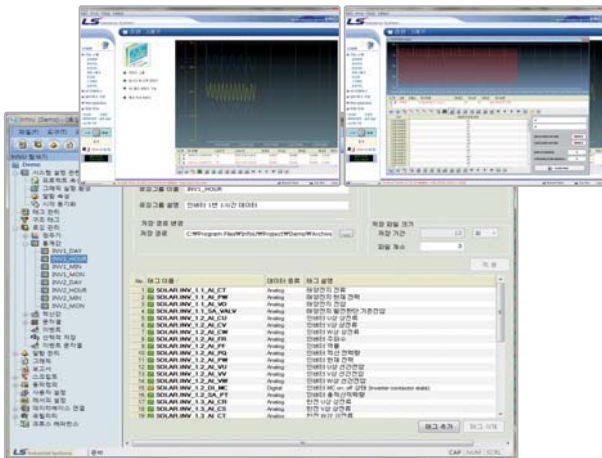

- XGT InfoU provides a strong tool for data analysis, which allows users to easily and quickly check collected data.
- External users can immediately view collected data using a Web Server via Web Browser.
- Data by period can be saved using an automatic backup function.
- Report function can be used to easily print out a report on collected data.

Record on Event Method

시간	비치 선간전압	1차 선간전압	1차 선간전압
01-04-16 06:22:50	22.82	22.83	26.29
01-04-16 06:21:82	21.82	22.16	26.16
01-04-16 06:21:45	21.45	21.45	26.00
01-04-16 06:20:52	20.52	20.47	26.25
01-04-16 06:20:60	20.60	20.07	26.29
01-04-16 06:20:23	20.23	20.13	26.62
01-04-16 06:20:07	20.07	20.60	26.77
01-04-16 06:21:62	20.00	21.62	27.00
01-04-16 06:20:07	20.07	22.30	27.16
01-04-16 06:20:33	20.33	22.87	27.39
01-04-16 06:20:60	20.60	22.83	27.56
01-04-16 06:21:06	21.06	22.16	27.19
01-04-16 06:21:45	21.45	21.45	27.93
01-04-16 06:21:96	21.96	20.47	27.16
01-04-16 06:22:30	22.30	20.07	27.32
01-04-16 06:22:67	22.67	20.13	27.95
01-04-16 06:22:63	22.63	20.40	27.71
01-04-16 06:22:30	22.30	21.62	27.86
01-04-16 06:22:67	22.67	22.30	27.71
01-04-16 06:22:57	22.57	22.87	27.40

- Besides the general logging method in which data are saved by time, non-cycle data generated under various methods such as Tag values can be recorded using event method.
- Time values are saved when recorded by event, and users can create a list of events to be used in a report, if necessary.

Records based on Statistical Calculation

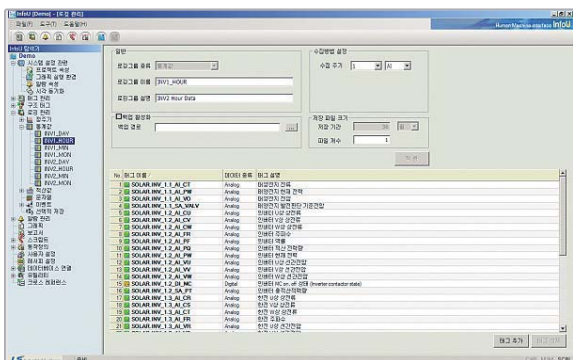

XGT InfoU can create statistical data without using an external application or separate script.

- ※ Statistical data can be used to easily create a complicated report.
- ※ Calculated statistical data can be directly used at Trend and so on.
- ※ In case of a digital tag, its holding time, and operating numbers can be directly

Convenient System Expansion

XGT InfoU provides a Wizard function for developers and operators to easily create a form and build a report system.

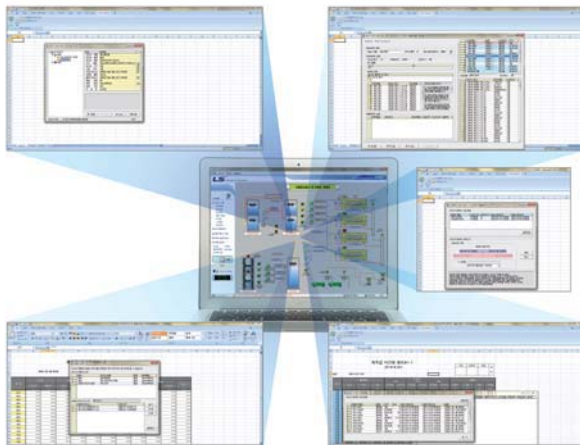

- Wizard function can be used in reports, which enables developers and operators to register a report form without relevant or additional skills.
- Fixed Cycle: Current analogue value and current digital status
- Statistical Value (Analogue): Current value, minimum value, maximum value, minimum time, maximum time, mean, sum and the number of samplings
- Statistical Value (Digital): On counts, runtime and the number of changes
- Daily, weekly and monthly reports can be printed or saved automatically, and duration can be assigned upon saving.
- Users can select and print any report form manually, if required.

XGT InfoU inquires logging data defined in a logging group to create or print a report on Excel Files at an assigned time.

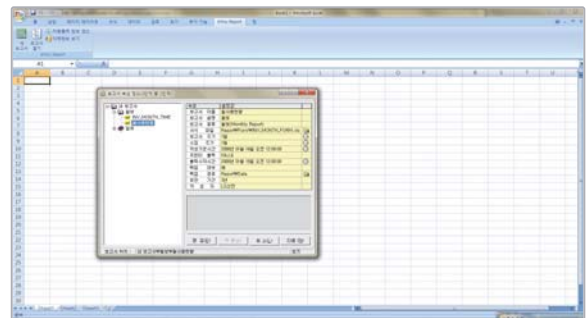

- Hourly, daily, weekly, monthly, yearly and temporary reports can be printed at any desired time.
- Convenient to create similar types of reports using a report duplication function.
- Easy to create a report layout using a drag-and-drop method.
- Since it uses Excel file format, functions such as the graph, diagram, form and statistics can be used as well.
- Tags used in reports can be inquired at Cross Reference, so usage in reports can be checked upon tag deletion and modification.

Support for Various Administrative Tasks with Easy and Quick Application Development

Statistical data can be configured using only parameters without the assistance of a separate script or external application, enabling users to quickly develop the required functions.

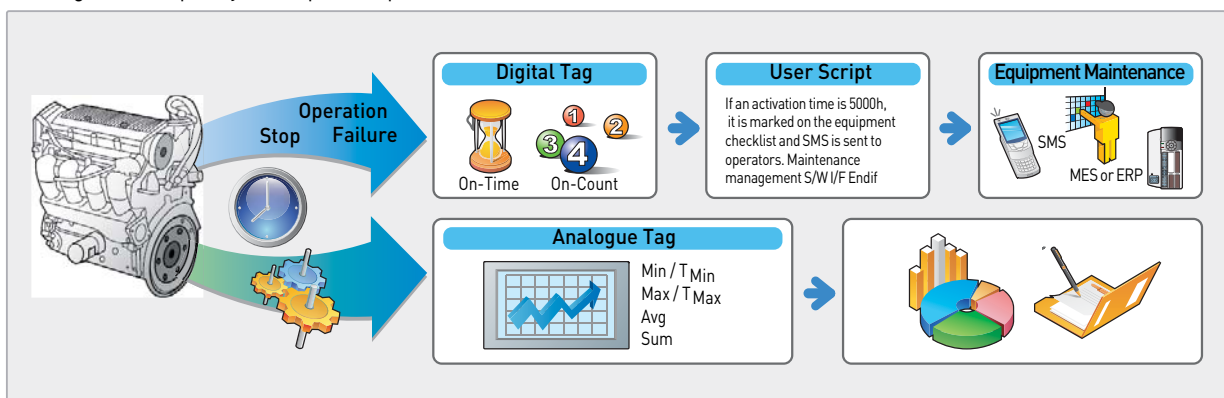

XGT Integration System

Tags created in XG5000 S/W are registered in XGT InfoU to reduce engineering time

Tag Integration

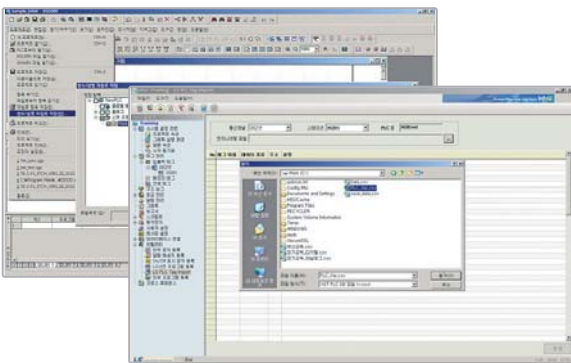

- Tags created in XG5000 S/W are registered in XGT InfoU to reduce engineering time.
- Variable names used in PLC are not changed to enhance intuitive development. Internal variables of PLC can be directly called from HMI, requiring no additional memory management program.

XGR Dual Network Support

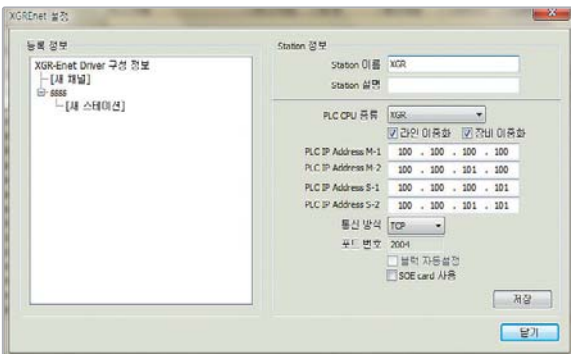

- By supporting XGR dual network, it is automatically switched within 100ms when a line is in failure. Thus, the system is uninterrupted even when communication failure is generated.
- Along with XGT InfoU dual system, Non-Stop System can be easily configured.

Simulator Link

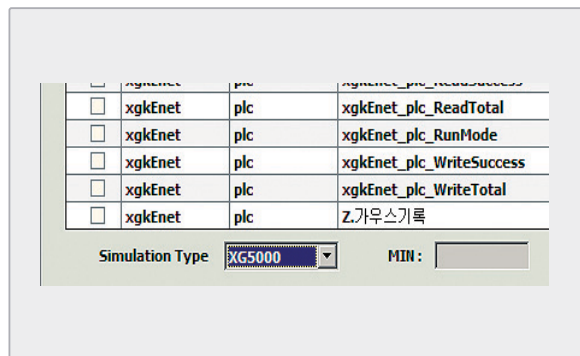

XGT InfoU run-time simulator can be connected with XG5000 simulator to share data without a PLC hardware.

XGT SOE Module Interface

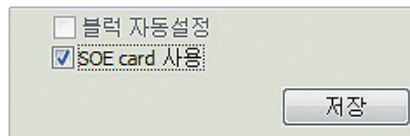

- Supports a time synchronization SOE module, which is XGT extension module, for automatic integration of SOE alarm data created in PLC into XGT InfoU alarm system.
- Upon creation of SOE alarm, an alarm group can be assigned for management by type and by location. If required, a built-in alarm viewer is used for analysis.

Worldwide Network

Head Office and Domestic Factories (Cheongju, Cheonan, Busan)

Domestic Factories

- Head Office
LS Tower, 127, LS-ro, Dongan-gu, Anyang-si, Gyeonggi-Do, 431-848, Korea
Tel : 82-2-2034-4870 Fax : 82-2-2034-3660-7021
- Cheongju Factory
1 Songjeong-dong, Cheongju-si, Chungbuk-do, 361-720, Korea
Tel : 82-43-261-6114 Fax : 82-43-261-6602
- Cheonan Factory
181 Samseong-ri, Mokcheon-myeon, Cheonan-si Chungnam-do, 330-840 Korea
Tel : 82-41-550-8114 Fax : 82-41-566-8408
- Busan Factory
1-19 Block Hwajeon-dong, Gangseo-gu, Busan, 618-280, Korea
Tel : 82-51-795-6114 Fax : 82-51-795-6169

Overseas Factories

- Wuxi Factory, CHINA
102-A, National High & New Tech Industrial Development Area, Wuxi, Jiangsu, 214028, P.R. China
Tel : 86-510-8534-6666 Fax : 86-510-8534-4078
- Dalian Factory, CHINA
No. 15, Liaohexi 3-Road, Economic and Technical Development zone, Dalian 116600, China
Tel : 86-411-273-7777 Fax : 86-411-8730-7560
- Hanoi Factory, VIETNAM
Room 1311, 13th Floor, M3-M4 Building 91 Nguyen Chi Thanh street, Hanoi, Vietnam.
Tel : 84-4-6275-8055 Fax : 84-4-6275-8056

R&D Center

- Advanced Technology R&D Center
533 Hogye-dong, Dongan-gu, Anyang-si, Gyeonggi-do, 431-749, Korea
Tel : 82-31-450-7114
- Electro Technology R&D Center
1 Songjeong-dong, Cheongju-si, Chungcheongbuk-do, 361-720, Korea
Tel : 82-43-261-6114
- Automation R&D Center
181 Samseong-ri, Mokcheon-myeon, Cheonan-si, Chungcheongnam-do, 330-840, Korea
Tel : 82-41-550-8272
- Power Testing & Technology Institute
1 Songjeong-dong, Cheongju-si, Chungcheongbuk-do, 361-720, Korea
Tel : 82-43-261-6114



Cheongju Factory



Wuxi Factory (China)



Cheonan Factory



Dalian Factory (China)



Busan Factory



Hanoi Factory (Vietnam)

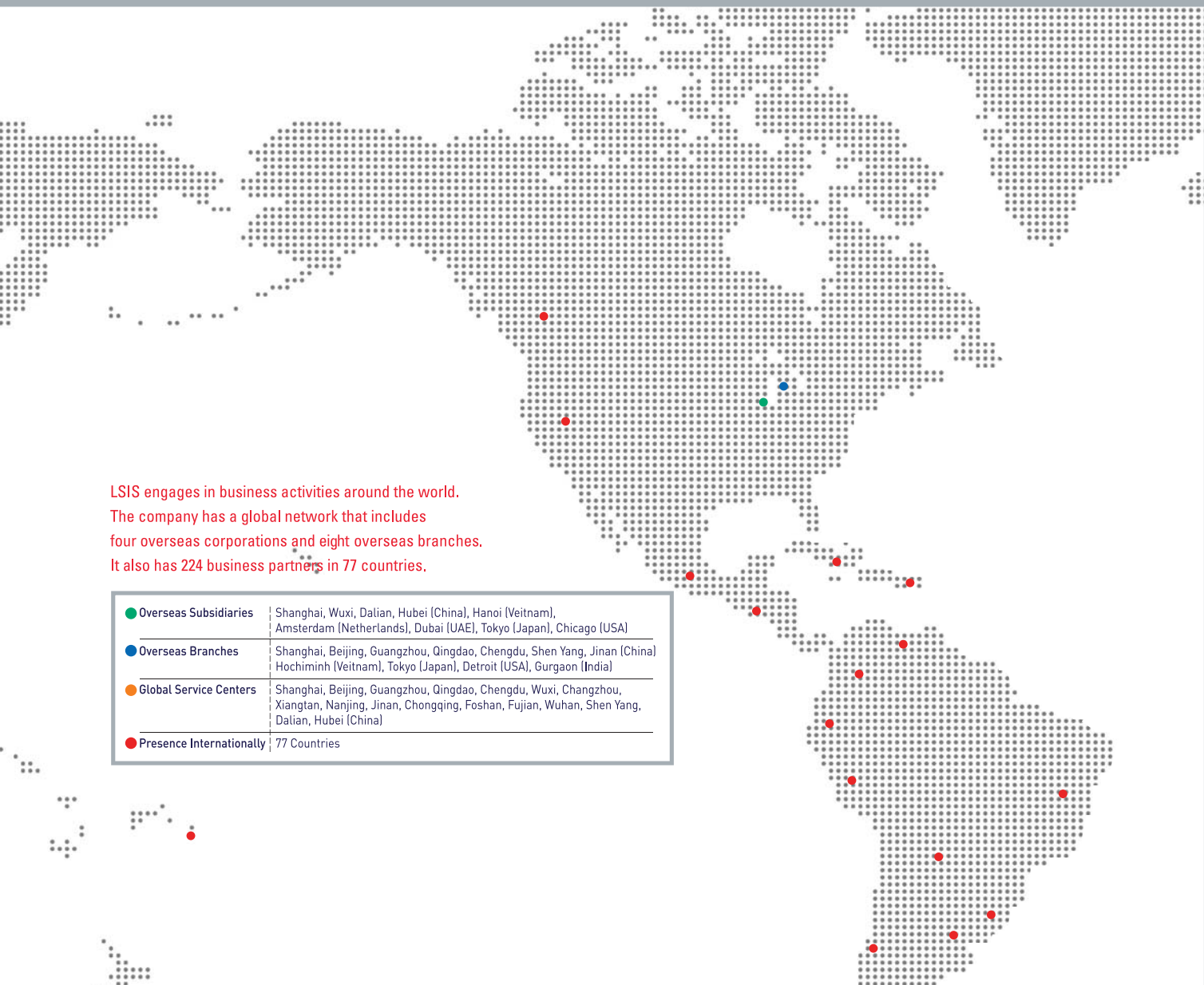

LSIS engages in business activities around the world.
 The company has a global network that includes
 four overseas corporations and eight overseas branches.
 It also has 224 business partners in 77 countries.

● Overseas Subsidiaries	Shanghai, Wuxi, Dalian, Hubei (China), Hanoi (Vietnam), Amsterdam (Netherlands), Dubai (UAE), Tokyo (Japan), Chicago (USA)
● Overseas Branches	Shanghai, Beijing, Guangzhou, Qingdao, Chengdu, Shen Yang, Jinan (China) Hochiminh (Vietnam), Tokyo (Japan), Detroit (USA), Gurgaon (India)
● Global Service Centers	Shanghai, Beijing, Guangzhou, Qingdao, Chengdu, Wuxi, Changzhou, Xiangtan, Nanjing, Jinan, Chongqing, Foshan, Fujian, Wuhan, Shen Yang, Dalian, Hubei (China)
● Presence Internationally	77 Countries

Overseas Subsidiaries

- LSIS(Shanghai) Co., Ltd. / CHINA
32nd Room 1-4, 32/F, Great Wall Building, No.3000 North Zhongshan Road, Putuo District, Shanghai, P.R. China
Tel : 86-21-5237-9977(609) Fax : 86-21-5237-7189
- LSIS(Dalian) Co., Ltd. / CHINA
No. 15, Liaohexi 3-Road, Economic and Technical Development zone, Dalian, P.R. China
Tel : 86-411-8731-7542 Fax : 86-411-8730-7560 E-Mail : dskim@lsis.com
- LSIS(Wuxi) Co., Ltd. / CHINA
102-A, National High & New Tech Industrial Development Area, Wuxi, Jiangsu, P.R. China
Tel : 86-510-8534-6666 Fax : 86-510-8534-4078 E-Mail : sojin@lsis.com
- LS Hukai Electric(Hubei) Co., Ltd. / CHINA
No. 100, Tanjahe Road, Dianjun District, Yichang City, Hubei Province, P.R. China
Tel : 86-717-667-7536 Fax : 86-717-667-7222 E-Mail : jaewoongh@lsis.com
- LS-VINA Industrial Systems Co., Ltd. / VIETNAM
Room 1311, 13th, M3-M4 Building 91 Nguyen Chi Thanh street, Hanoi, Vietnam
Tel : 84-4-6275-8055 Fax : 86-21-5237-7189
- LSIS[ME] FZE / U.A.E.
LOB 19-205, JAFZA View Tower, Jebel Ali Free Zone, Dubai, United Arab Emirates
Tel : 971-4-886-5360 Fax : 971-4-886-5361 E-Mail : shunlee@lsis.com
- LSIS Europe B.V. / NETHERLANDS
1st. Floor, Tupolevlaan 48, 1119NZ, Schiphol-Rijk, The Netherlands
Tel : 31-20-654-1420 Fax : 31-20-654-1429 E-Mail : europartner@lsis.com
- LSIS Japan Co., Ltd. / JAPAN
16th, Higashi-Kan, Akasaka Twin Tower, 2-17-22, Akasaka, Minato-ku, Tokyo, Japan
Tel : 81-3-3582-9128 Fax : 81-3-3582-2667 E-Mail : jschuna@lsis.com
- LSIS USA Inc. / U.S.A.
2000 Millbrook Drive, Lincolnshire, Chicago, IL 60069, United States of America
Tel : 847-941-8240 Fax : 847-941-8259

Overseas Branches

- LSIS Shanghai Office / CHINA
Room E-G, 12th, Huamin Empire Plaza, No.726, West Yan'an Road, Shanghai, P.R. China
Tel : 86-21-5237-9977(702) Fax : 86-21-5237-7189
- LSIS Beijing Office / CHINA
Room 2306, Building B Landgent Center, No.24 Middle Road, East 3rd Ring Road, Chaoyang District, Beijing, P.R. China
Tel : 86-10-5761-3127 Fax : 86-10-5761-3128 E-Mail : htroh@lsis.com
- LSIS Guangzhou Office / CHINA
Room 1403, 14th, New Poly Tower, 2 Zhongshan Liu Road, Guangzhou, P.R. China
Tel : 86-20-8326-6784 Fax : 86-20-8326-6287 E-Mail : sojhtroh@lsis.com
- LSIS Qingdao Office / CHINA
Room 2001, Galaxy Building, 29 ShanDong Road, ShiNan District, QingDao, ShanDong, P.R. China
Tel : 86-532-8501-6058 Fax : 86-532-8501-6057 E-Mail : htroh@lsis.com
- LSIS Chengdu Office / CHINA
Room 1710, 17/F Huamin Empire Plaza, NO.1 Fuxin Road, Chengdu, P.R. China
Tel : 86-28-8670-3201 Fax : 86-28-8670-3203 E-Mail : yangcf@lsis.com
- LSIS ShenYang Office / CHINA
Room 803, Hongyuan Building, 52 South Nanjing Road, Heping District, Shenyang, P.R. China
Tel : 86-24-2321-9050 Fax : 86-24-8386-7210 E-Mail : yangcf@lsis.com
- LSIS Jinan Office / CHINA
Room 417, Chuangzhan Center, No. 201, Shanda Road, Lixia District, Jinan, Shandong, P.R. China
Tel : 86-531-8263-8026 Fax : 86-531-8263-8027 E-Mail : yangcf@lsis.com
- LSIS Tokyo Office / JAPAN
16th, Higashi-Kan, Akasaka Twin Tower, 2-17-22, Akasaka, Minato-ku, Tokyo, Japan
Tel : 81-3-3582-9128 Fax : 81-3-3582-2667
- LS-VINA Industrial Systems Hochiminh Office / VIETNAM
4th, Yoco Building, 41 Nguyen Thi Minh Khai Street, Hochiminh City, Vietnam
Tel : 84-8-3822-7941 Fax : 81-84-8-3822-7942 E-Mail : sjbaik@lsis.com
- LSIS Detroit Office / U.S.A.
5700 Crooks Rd, Suite 211, Troy, MI 48098, United States of America
Tel : 1-248-792-2637-8 Fax : 1-248-792-2642t E-Mail : sylee@lsis.com
- LSIS Gurgaon Office / INDIA
109 First Floor, Park Central, Sector-30, Gurgaon- 122 002, Haryana, India
Tel : +0091-124-493-0070 Fax : 91-1244-930-066 E-Mail : hwyim@lsis.com



Safety Instructions

- For your safety, please read user's manual thoroughly before operating.
- Contact the nearest authorized service facility for examination, repair, or adjustment.
- Please contact qualified service technician when you need maintenance.
Do not disassemble or repair by yourself !
- Any maintenance and inspection shall be performed by the personnel having expertise concerned.

LSIS Co., Ltd.

©2006. LSIS Co., Ltd. All Rights Reserved.

HEAD OFFICE

LS Tower, 127, LS-ro, Dongan-gu, Anyang-si, Gyeonggi-Do, 431-848, Korea

■ Southeast Asia	+82-2-2034-4888	cshwang@lsis.com (Charles Hwang)
■ Europe	+82-2-2034-4676	sukyong@lsis.com (Brian Choi)
■ Turkey/Israel/CIS	+82-2-2034-4879	dkimc@lsis.com (Daniel Kim)
■ Oceania	+82-2-2034-4394	kacho@lsis.com (Kendra Cho)
■ North/Latin America	+82-2-2034-4286	hkchung@lsis.com (Hank Raul Chung)
■ Southwest Asia/Africa	+82-2-2034-4467	myleed@lsis.com (Henry Lee)
■ Middle East	+971-4-886-5360	khchoi1@lsis.com (Lambert Choi)

Overseas Subsidiaries

- **LSIS(Shanghai) Co., Ltd. /CHINA**
32nd Room 1-4, 32/F, Great Wall Building, No.3000 North Zhongshan Road, Putuo District, Shanghai, P.R. China
Tel : 86-21-5237-9977(609) Fax : 86-21-5237-7189
- **LSIS(Dalian) Co., Ltd. /CHINA**
No. 15, Liaohexi 3-Road, Economic and Technical Development zone, Dalian, P.R. China
Tel : 86-411-8731-7542 Fax : 86-411-8730-7560 E-Mail : dskim@lsis.com
- **LSIS(Wuxi) Co., Ltd./CHINA**
102-A, National High & New Tech Industrial Development Area, Wuxi, Jiangsu, P.R. China
Tel : 86-510-8534-6666 Fax : 86-510-8534-4078 E-Mail : sojin@lsis.com
- **LS Hukai Electric(Hubei) Co., Ltd./CHINA**
No. 100, Tanjiahe Road, Dianjun District, Yichang City, Hubei Province, P.R. China
Tel : 86-717-667-7536 Fax : 86-717-667-7222 E-Mail : jaewoongh@lsis.com
- **LS-VINA Industrial Systems Co., Ltd./VIETNAM**
Room 1311, 13th, M3-M4 Building 91 Nguyen Chi Thanh street, Hanoi, Vietnam
Tel : 84-4-6275-8055 Fax : 86-21-5237-7189
- **LSIS(IME) FZE/U.A.E.**
LOB 19-205, JAFZA View Tower, Jebel Ali Free Zone, Dubai, United Arab Emirates
Tel : 971-4-886-5360 Fax : 971-4-886-5361 E-Mail : shunlee@lsis.com
- **LSIS Europe B.V./NETHERLANDS**
1st. Floor, Tupolevlaan 48, 1119NZ, Schiphol-Rijk, The Netherlands
Tel : 31-20-654-1420 Fax : 31-20-654-1429 E-Mail : europartner@lsis.com
- **LSIS Japan Co., Ltd./JAPAN**
16th, Higashi-Kan, Akasaka Twin Tower, 2-17-22, Akasaka, Minato-ku, Tokyo, Japan
Tel : 81-3-3582-9128 Fax : 81-3-3582-2667 E-Mail : jschuna@lsis.com
- **LSIS USA Inc./U.S.A.**
2000 Millbrook Drive, Lincolnshire, Chicago, IL 60069, United States of America
Tel : 847-941-8240 Fax : 847-941-8259

Overseas Branches

- **LSIS Shanghai Office/CHINA**
Room E-6, 12th, Huamin Empire Plaza, No.726, West Yan'an Road, Shanghai, P.R. China
Tel : 86-21-5237-9977(702) Fax : 86-21-5237-7189
- **LSIS Beijing Office/CHINA**
Room 2306, Building B Landgent Center, No.24 Middle Road, East 3rd Ring Road, Chaoyang District, Beijing, P.R. China
Tel : 86-10-5761-3127 Fax : 86-10-5761-3128 E-Mail : htroh@lsis.com
- **LSIS Guangzhou Office/CHINA**
Room 1403, 14th, New Poly Tower, 2 Zhongshan Liu Road, Guangzhou, P.R. China
Tel : 86-20-8326-6784 Fax : 86-20-8326-6287 E-Mail : sojhtroh@lsis.com
- **LSIS Qingdao Office/CHINA**
Room 2001, Galaxy Building, 29 ShanDong Road, ShiNan District, QingDao, ShanDong, P.R. China
Tel : 86-532-8501-6058 Fax : 86-532-8501-6057 E-Mail : htroh@lsis.com
- **LSIS Chengdu Office/CHINA**
Room1710, 17/F Huamin Empire Plaza, NO.1 Fuxin Road, Chengdu, P.R. China
Tel : 86-28-8670-3201 Fax : 86-28-8670-3203 E-Mail : yangcf@lsis.com
- **LSIS ShenYang Office/CHINA**
Room 803, Hongyuan Building, 52 South Nanjing Road, Heping District, Shenyang, P.R. China
Tel : 86-24-2321-9050 Fax : 86-24-8386-7210 E-Mail : yangcf@lsis.com
- **LSIS Jinan Office/CHINA**
Room 417, Chuangzhan Center, No. 201, Shanda Road, Lixia District, Jinan, Shandong, P. R. China
Tel : 86-531-8263-8026 Fax : 86-531-8263-8027 E-Mail : yangcf@lsis.com
- **LSIS Tokyo Office/JAPAN**
16th, Higashi-Kan, Akasaka Twin Tower, 2-17-22, Akasaka, Minato-ku, Tokyo, Japan
Tel : 81-3-3582-9128 Fax : 81-3-3582-2667
- **LS-VINA Industrial Systems Hochiminh Office/VIETNAM**
4th, Yoco Building, 41 Nguyen Thi Minh Khai Street, Hochiminh City, Vietnam
Tel : 84-8-3822-7941 Fax : 81-84-8-3822-7942 E-Mail : sjbaik@lsis.com
- **LSIS Detroit Office/U.S.A.**
5700 Crooks Rd, Suite 211, Troy, MI 48098, United States of America
Tel : 1-248-792-2637-8 Fax : 1-248-792-2642 E-Mail : sylee@lsis.com
- **LSIS Gurgaon Office/INDIA**
109 First Floor, Park Central, Sector-30, Gurgaon- 122 002, Haryana, India
Tel : +0091-124-493-0070 Fax : 91-1244-930-066 E-Mail : hwyim@lsis.com

Specifications in this catalog are subject to change without notice due to continuous product development and improvement.