

HF2100

MINIATURE HIGH POWER RELAY



File No.:E134517



File No.:R50153835



File No.:CQC08002027546



Features

- 30A switching capability
- PCB coil terminals, ideal for heavy duty load
- 2.5kV dielectric strength (between coil and contacts)
- Plastic sealed and flux proofed types available
- Class F insulation available
- Environmental friendly product (RoHS compliant)
- Outline Dimensions: (32.2 x 27.5 x 28.0) mm

CONTACT DATA

Contact arrangement	1A	1B	1C (NO)	1C (NC)
Contact resistance	50mΩ (at 1A 24VDC)			
Contact material	AgCdO			
Contact rating (Res. load)	30A 240VAC 20A 30VDC	15A 240VAC 10A 30VDC	20A 240VAC 20A 30VDC	10A 240VAC 10A 30VDC
Max. switching power	7200VA 600W	3600VA 300W	4800VA 600W	2400VA 300W
Max. switching voltage	277VAC / 30VDC			
Max. switching current	40A	15A	20A	10A
Mechanical endurance	1 x 10 ⁷ OPS			
Electrical endurance	1 x 10 ⁵ OPS ¹ (See approval reports for more details)			

CHARACTERISTICS

Insulation resistance	1000MΩ (at 500VDC)	
Dielectric strength	Between coil & contacts	2500VAC 1min
	Between open contacts	1500VAC 1min
Operate time (at nomi. volt.)	15ms max.	
Release time (at nomi. volt.)	10ms max.	
Ambient temperature	-55°C to 85°C	
Shock resistance	Functional	98m/s ²
	Destructive	980m/s ²
Vibration resistance	10Hz to 55Hz 1.5mm DA	
Humidity	98% RH, 40°C	
Termination	PCB & QC	
Unit weight	Approx. 35g	
Construction	Plastic sealed, Dust protected	

- Notes:** 1) Typical rating and electrical endurance: at 30A 240VAC, resistive, on & off: 1:9, 100k cycles, 1 Form A, please open the vent hole after welding and cleaning.
2) The data shown above are initial values.
3) Please find coil temperature curve in the characteristic curves below.

COIL

Coil power	Approx. 900mW
------------	---------------

COIL DATA at 23°C

Nominal Voltage VDC	Pick-up Voltage VDC	Drop-out Voltage VDC	Max. Allowable Voltage VDC	Coil Resistance Ω
5	3.75	0.5	6.5	27 x (1±10%)
6	4.50	0.6	7.8	40 x (1±10%)
9	6.75	0.9	11.7	97 x (1±10%)
12	9.00	1.2	15.6	155 x (1±10%)
15	11.25	1.5	19.5	256 x (1±10%)
18	13.50	1.8	23.4	380 x (1±10%)
24	18.00	2.4	31.2	660 x (1±10%)
48	36.00	4.8	62.4	2560 x (1±10%)
70	52.50	7.0	91.0	5500 x (1±10%)
110	82.50	11.0	143.0	13450 x (1±10%)



HONGFA RELAY

ISO9001, ISO/TS16949, ISO14001, OHSAS18001, IECQ QC 080000 CERTIFIED

2010 Rev. 1.00

SAFETY APPROVAL RATINGS

UL/CUL

Load type	Volts	1 Form A	1 Form B	1 Form C (NO)	1 Form C (NC)
General purpose	125/240VAC	30A	15A	30A	15A
	277VAC	30A	30A	30A	30A
Resistive	125/240VAC	30A	15A	--	--
	30VDC	20A	10A	20A	10A
	277VAC	20A	--	--	--
	240VAC	15A	--	--	--
	250VAC	40A	--	40A	--
Ballast	125/240/277VAC	6A	3A	6A	3A
Pilot duty	125VAC	800VA	290VA	800VA	290VA
	125VAC	690VA	--	690VA	--
	125VAC	800VA	--	800VA	--
	240VAC	1152VA	768VA	1152VA	768VA
	277VAC	764VA	--	764VA	--
Motor load	125VAC	1HP	1/4HP	1HP	1/4HP
	240VAC	2HP	1HP	2HP	1HP
	125VAC	1HP	--	1HP	--
	125/277VAC	3/4HP	--	3/4HP	--
Definite purpose (LRA-loaded rotor) (FLA-full load)	120VAC	82.8LRA, 13.8FLA	--	82.8LRA, 13.8FLA	--
	125VAC	96LRA, 30FLA	33LRA, 10FLA	60LRA, 20FLA	33LRA, 10FLA
	125VAC	60LRA, 20FLA	30LRA, 12FLA	60LRA, 20FLA	30LRA, 12FLA
	125VAC	82.8LRA, 27FLA	--	82.8LRA, 27FLA	--
	240VAC	80LRA, 30FLA	33LRA, 10FLA	60LRA, 20FLA	33LRA, 10FLA
	240VAC	41.4LRA, 6.9FLA	--	41.4LRA, 6.9FLA	--
	277VAC	60LRA, 20FLA	--	60LRA, 20FLA	--
Tungsten	125VAC	15A	--	15A	--
	240VAC	5A	--	5A	3A
	120VAC	--	3A	--	--
	240VAC	--	3A	--	--

Notes: Only some typical ratings are listed above. If more details are required, please contact us.

ORDERING INFORMATION

Type	HF2100	-1A	-12D	E	F	(XXX)
Contact arrangement	1A: 1Form A	1B: 1Form B	1C: 1Form C			
Coil voltage	5, 6, 9, 12, 15, 18, 24, 48, 70, 110VDC					
Construction ¹⁾	E: Plastic sealed		Nil: Dust protected			
Insulation standard	F: Class F		Nil: Class B			
Customer special code						

- Notes:** 1) We recommend dust protected types for a clean environment (free from contaminations like H₂S, SO₂, NO₂, dust, etc.). We suggest to choose plastic sealed types and validate it in real application for an unclean environment (with contaminations like H₂S, SO₂, NO₂, dust, etc.).
 If water cleaning is required after the relay is assembled on PCB, please contact us for suggestion about suitable parts.
 2) To avoid using relays under strong magnetic field which will change the parameters of relays such as pick-up voltage and drop-out voltage.
 3) Relays may be damaged because of falling or when shocking conditions exceed the requirement.
 4) Regarding the plastic sealed relay, we should leave it cooling naturally until below 40°C after welding, then clean it and deal with coating, remarkably the temperature of solvents should also be controlled below 40°C. Please avoid cleaning the relay by ultrasonic, avoid using the solvents like gasoline, Freon, and so on, which would affect the configuration of relay or influence the environment.
 5) About preferable condition of operation, storage and transportation, please refer to "Explanation to terminology and guidelines of relay".

OUTLINE DIMENSIONS, WIRING DIAGRAM AND PC BOARD LAYOUT

Unit: mm

1 Form A

Outline Dimensions

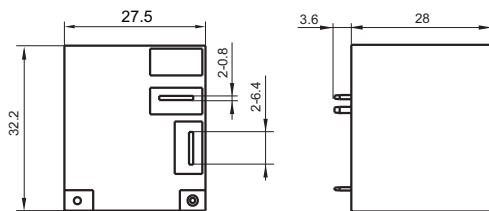

Wiring Diagram

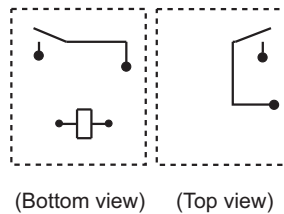

PCB Layout
(Bottom view)

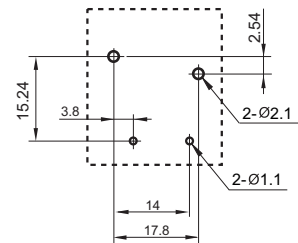

OUTLINE DIMENSIONS, WIRING DIAGRAM AND PC BOARD LAYOUT

Unit: mm

1 Form B

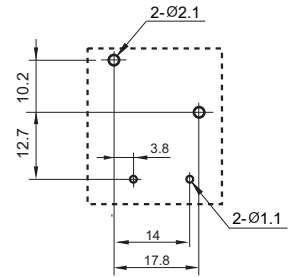
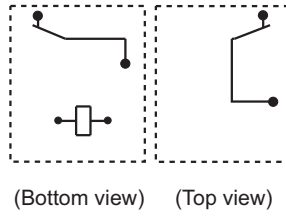
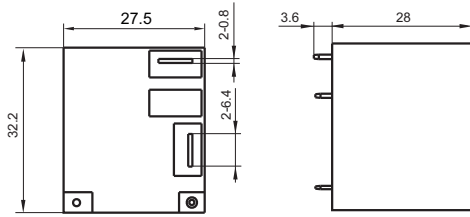

1 Form C

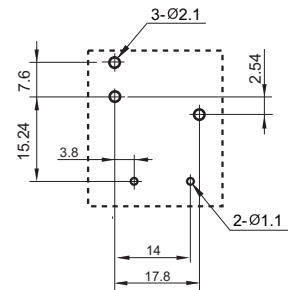
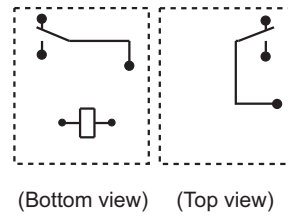
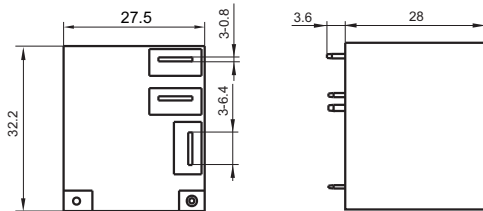

Remark: 1) In case of no tolerance shown in outline dimension: outline dimension $\leq 1\text{mm}$, tolerance should be $\pm 0.2\text{mm}$; outline dimension $> 1\text{mm}$ and $\leq 5\text{mm}$, tolerance should be $\pm 0.3\text{mm}$; outline dimension $> 5\text{mm}$, tolerance should be $\pm 0.4\text{mm}$.
2) The tolerance without indicating for PCB layout is always $\pm 0.1\text{mm}$.

CHARACTERISTIC CURVES

MAXIMUM SWITCHING POWER

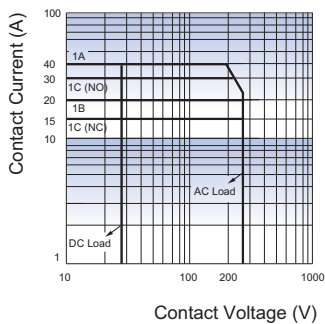

ENDURANCE CURVE

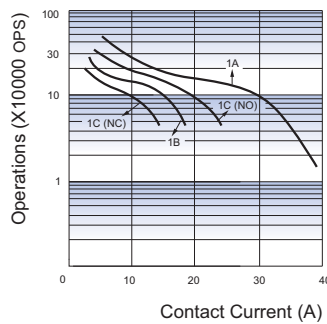

COIL TEMPERATURE RISE

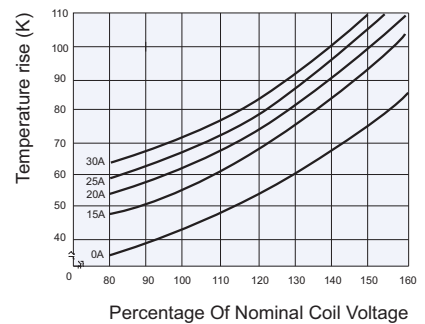

Disclaimer

This datasheet is for the customers' reference. All the specifications are subject to change without notice. We could not evaluate all the performance and all the parameters for every possible application. Thus the user should be in a right position to choose the suitable product for their own application. If there is any query, please contact Hongfa for the technical service. However, it is the user's responsibility to determine which product should be used only.

© Xiamen Hongfa Electroacoustic Co., Ltd. All rights of Hongfa are reserved.