

This operation manual is intended for users with basic knowledge of electricity and electric devices.

* LSLV-S100 is the official name for S100.

Safety Information

Read and follow all safety instructions in this manual precisely to avoid unsafe operating conditions, property damage, personal injury, or death.

Safety symbols in this manual



Indicates an imminently hazardous situation which, if not avoided, will result in severe injury or death.



Indicates a potentially hazardous situation which, if not avoided, could result in injury or death.

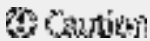

Indicates a potentially hazardous situation that, if not avoided, could result in minor injury or property damage.

Safety information



- Do not open the cover of the equipment while it is on or operating. Likewise, do not operate the inverter while the cover is open. Exposure of high voltage terminals or charging area to the external environment may result in an electric shock. Do not remove any covers or touch the internal circuit boards (PCBs) or electrical contacts on the product when the power is on or during operation. Doing so may result in serious injury, death, or serious property damage.
- Do not open the cover of the equipment even when the power supply to the inverter has been turned off unless it is necessary for maintenance or regular inspection. Opening the cover may result in an electric shock even when the power supply is off.
- The equipment may hold charge long after the power supply has been turned off. Use a multi-meter to make sure that there is no voltage before working on the inverter, motor or motor cable.

 **Warning**

- This equipment must be grounded for safe and proper operation.
- Do not supply power to a faulty inverter. If you find that the inverter is faulty, disconnect the power supply and have the inverter professionally repaired.
- The inverter becomes hot during operation. Avoid touching the inverter until it has cooled to avoid burns.
- Do not allow foreign objects, such as screws, metal chips, debris, water, or oil to get inside the inverter. Allowing foreign objects inside the inverter may cause the inverter to malfunction or result in a fire.
- Do not operate the inverter with wet hands. Doing so may result in electric shock.

 **Caution**

- Do not modify the interior workings of the inverter. Doing so will void the warranty.
- The inverter is designed for 3-phase motor operation. Do not use the inverter to operate a single phase motor.
- Do not place heavy objects on top of electric cables. Doing so may damage the cable and result in an electric shock.

Note

Maximum allowed prospective short-circuit current at the input power connection is defined in IEC 60439-1 as 100 kA. Depending on the selected MCCB, the LSLV-S100 Series is suitable for use in circuits capable of delivering a maximum of 100 kA RMS symmetrical amperes at the drive's maximum rated voltage. The following table shows the recommended MCCB for RMS symmetrical amperes.

Remarque

Le courant maximum de court-circuit présumé autorisé au connecteur d'alimentation électrique est défini dans la norme IEC 60439-1 comme égal à 100 kA. Selon le MCCB sélectionné, la série LSLV-S100 peut être utilisée sur des circuits pouvant fournir un courant RMS symétrique de 100 kA maximum en ampères à la tension nominale maximale du variateur. Le tableau suivant indique le MCCB recommandé selon le courant RMS symétrique en ampères.

Working Voltage	UTE100(E/N)	UTS150(N/H/L)	ABS33c	ABS53c	ABS63c	ABS103c
240V(50/60Hz)	50/65 kA	65/100/150 kA	30 kA	35 kA	35 kA	85 kA
480V(50/60Hz)	25/35 kA	35/65/100 kA	7.5 kA	10 kA	10 kA	26 kA

Quick Reference Table

The following table contains situations frequently encountered by users while working with inverters. Refer to the typical and practical situations in the table to quickly and easily locate answers to your questions.

Situation	Reference
I want to run a slightly higher rated motor than the inverter's rated capacity.	<u>p. 198</u>
I want to configure the inverter to start operating as soon as the power source is applied.	<u>p. 84</u>
I want to configure the motor's parameters.	<u>p.144</u>
I want to set up sensorless vector control.	<u>p.147</u>
Something seems to be wrong with the inverter or the motor.	<u>p. 216, p.327</u>
What is auto tuning?	<u>p.144</u>
What are the recommended wiring lengths?	<u>p. 216, p.327</u>
The motor is too noisy.	<u>p. 164</u>
I want to apply PID control on my system.	<u>p. 136</u>
What are the factory default settings for P1-P7 multi-function terminals?	<u>p. 30</u>
I want to view all of the parameters I have modified.	<u>p. 173</u>
I want to review recent fault trip and warning histories.	<u>p. 292</u>
I want to change the inverter's operation frequency using a potentiometer.	<u>p. 57</u>
I want to install a frequency meter using an analog terminal.	<u>p. 31</u>
I want to display the supply current to motor.	<u>p. 60</u>
I want to operate the inverter using a multi-step speed configuration.	<u>p. 77</u>
The motor runs too hot.	<u>p. 197</u>
The inverter is too hot.	<u>p. 205</u>
The cooling fan does not work.	<u>p. 333</u>
I want to change the items that are monitored on the keypad.	<u>p. 193</u>

Table of Contents

1	Preparing the Installation	1
1.1	Product Identification.....	1
1.2	Part Names.....	3
1.3	Installation Considerations.....	5
1.4	Selecting and Preparing a Site for Installation.....	6
1.5	Cable Selection.....	10
2	Installing the Inverter	13
2.1	Mounting the Inverter	15
2.2	Cable Wiring.....	19
2.3	Post-Installation Checklist.....	38
2.4	Test Run	39
3	Learning to Perform Basic Operations	43
3.1	About the Keypad.....	43
3.1.1	About the Display.....	44
3.1.2	Operation Keys.....	45
3.1.3	Control Menu.....	46
3.2	Learning to Use the Keypad.....	47
3.2.1	Group and Code Selection.....	47
3.2.2	Navigating Directly to Different Codes.....	48
3.2.3	Setting Parameter Values.....	49
3.2.4	Configuring the [ESC] Key	50
3.3	Actual Application Examples	51
3.3.1	Acceleration Time Configuration.....	51
3.3.2	Frequency Reference Configuration.....	52
3.3.3	Jog Frequency Configuration.....	54
3.3.4	Initializing All Parameters.....	54
3.3.5	Frequency Setting (Keypad) and Operation (via Terminal Input)	56
3.3.6	Frequency Setting (Potentiometer) and Operation (Terminal Input)	57
3.3.7	Frequency Setting (Potentiometer) and Operation (Keypad)	58

3.4	Monitoring the Operation	60
3.4.1	Output Current Monitoring.....	60
3.4.2	Fault Trip Monitoring.....	61
4	Learning Basic Features.....	63
4.1	Setting Frequency Reference.....	66
4.1.1	Keypad as the Source (KeyPad-1 setting).....	66
4.1.2	Keypad as the Source (KeyPad-2 setting).....	66
4.1.3	V1 Terminal as the Source.....	67
4.1.4	Setting a Frequency Reference with Input Voltage (Terminal I2).....	74
4.1.5	Setting a Frequency with TI Pulse Input.....	74
4.1.6	Setting a Frequency Reference via RS-485 Communication.....	76
4.2	Frequency Hold by Analog Input.....	76
4.3	Changing the Displayed Units (Hz↔Rpm).....	77
4.4	Setting Multi-step Frequency	77
4.5	Command Source Configuration.....	79
4.5.1	The Keypad as a Command Input Device.....	79
4.5.2	Terminal Block as a Command Input Device (Fwd/Rev Run Commands).....	80
4.5.3	Terminal Block as a Command Input Device (Run and Rotation Direction Commands).....	81
4.5.4	RS-485 Communication as a Command Input Device.....	81
4.6	Local/Remote Mode Switching.....	82
4.7	Forward or Reverse Run Prevention	84
4.8	Power-on Run.....	84
4.9	Reset and Restart.....	85
4.10	Setting Acceleration and Deceleration Times.....	86
4.10.1	Acc/Dec Time Based on Maximum Frequency.....	86
4.10.2	Acc/Dec Time Based on Operation Frequency.....	88
4.10.3	Multi-step Acc/Dec Time Configuration.....	88
4.10.4	Configuring Acc/Dec Time Switch Frequency	90
4.11	Acc/Dec Pattern Configuration	91
4.12	Stopping the Acc/Dec Operation.....	94

4.13	V/F(Voltage/Frequency) Control	94
4.13.1	Linear V/F Pattern Operation.....	94
4.13.2	Square Reduction V/F pattern Operation.....	95
4.13.3	User V/F Pattern Operation	96
4.14	Torque Boost.....	97
4.14.1	Manual Torque Boost	97
4.14.2	Auto Torque Boost.....	98
4.15	Output Voltage Setting	98
4.16	Start Mode Setting.....	99
4.16.1	Acceleration Start.....	99
4.16.2	Start After DC Braking.....	100
4.17	Stop Mode Setting.....	100
4.17.1	Deceleration Stop	100
4.17.2	Stop After DC Braking.....	101
4.17.3	Free Run Stop.....	102
4.17.4	Power Braking.....	103
4.18	Frequency Limit.....	104
4.18.1	Frequency Limit Using Maximum Frequency and Start Frequency	104
4.18.2	Frequency Limit Using Upper and Lower Limit Frequency Values	104
4.18.3	Frequency Jump.....	105
4.19	2 nd Operation Mode Setting.....	106
4.20	Multi-function Input Terminal Control	107
4.21	P2P Setting.....	108
4.22	Multi-keypad Setting.....	110
4.23	User Sequence Setting	111
4.24	Fire Mode Operation	117
5	Learning Advanced Features.....	121
5.1	Operating with Auxiliary References.....	122
5.2	Jog operation	126
5.2.1	Jog Operation 1-Forward Jog by Multi-function Terminal	126
5.2.2	Jog Operation 2-Fwd/Rev Jog by Multi-function Terminal	128

5.2.3	Jog Operation by Keypad	128
5.3	Up-down Operation	129
5.4	3-Wire Operation	130
5.5	Safe Operation Mode	131
5.6	Dwell Operation	133
5.7	Slip Compensation Operation	134
5.8	PID Control	136
5.8.1	PID Basic Operation	136
5.8.2	Pre-PID Operation	142
5.8.3	PID Operation Sleep Mode	142
5.8.4	PID Switching (PID Openloop)	143
5.9	Auto Tuning	144
5.10	Sensorless Vector Control	147
5.10.1	Sensorless Vector Control Operation Setting	149
5.10.2	Sensorless Vector Control Operation Guide	152
5.11	Kinetic Energy Buffering Operation	154
5.12	Torque Control	155
5.13	Energy Saving Operation	158
5.13.1	Manual Energy Saving Operation	158
5.13.2	Automatic Energy Saving Operation	158
5.14	Speed Search Operation	159
5.15	Auto Restart Settings	163
5.16	Operational Noise Settings (carrier frequency settings)	164
5.17	2 nd Motor Operation	166
5.18	Supply Power Transition	167
5.19	Cooling Fan Control	168
5.20	Input Power Frequency and Voltage Settings	169
5.21	Read, Write, and Save Parameters	170
5.22	Parameter Initialization	170
5.23	Parameter View Lock	171
5.24	Parameter Lock	172
5.25	Changed Parameter Display	173

5.26	User Group	173
5.27	Easy Start On	175
5.28	Config(CNF) Mode	176
5.29	Timer Settings	177
5.30	Brake Control	178
5.31	Multi-Function Output On/Off Control	179
5.32	Press Regeneration Prevention	180
5.33	Analog Output.....	181
5.33.1	Voltage and Current Analog Output.....	181
5.33.2	Analog Pulse Output.....	184
5.34	Digital Output	187
5.34.1	Multi-function Output Terminal and Relay Settings	187
5.34.2	Fault Trip Output using Multi-Function Output Terminal and Relay	191
5.34.3	Multi-function Output Terminal Delay Time Settings	192
5.35	Keypad Language Settings	193
5.36	Operation State Monitor	193
5.37	Operation Time Monitor	195
6	Learning Protection Features.....	197
6.1	Motor Protection	197
6.1.1	Electronic Thermal Motor Overheating Prevention (ETH)	197
6.1.2	Overload Early Warning and Trip	198
6.1.3	Stall Prevention and Flux Braking	200
6.2	Inverter and Sequence Protection.....	203
6.2.1	Open-phase Protection	203
6.2.2	External Trip Signal	204
6.2.3	Inverter Overload Protection	205
6.2.4	Speed Command Loss	206
6.2.5	Dynamic Braking (DB) Resistor Configuration	208
6.3	Under load Fault Trip and Warning.....	209
6.3.1	Fan Fault Detection	211
6.3.2	Lifetime diagnosis of components	211

6.3.3	Low Voltage Fault Trip.....	213
6.3.4	Output Block by Multi-Function Terminal.....	214
6.3.5	Trip Status Reset.....	214
6.3.6	Inverter Diagnosis State.....	215
6.3.7	Operation Mode on Option Card Trip.....	215
6.3.8	No Motor Trip.....	216
6.3.9	Low voltage trip 2.....	216
6.4	Fault/Warning List.....	216
7	RS-485 Communication Features.....	219
7.1	Communication Standards.....	219
7.2	Communication System Configuration.....	219
7.2.1	Communication Line Connection.....	220
7.2.2	Setting Communication Parameters.....	220
7.2.3	Setting Operation Command and Frequency.....	222
7.2.4	Command Loss Protective Operation.....	223
7.2.5	Setting Virtual Multi-Function Input.....	223
7.2.6	Saving Parameters Defined by Communication.....	224
7.2.7	Total Memory Map for Communication.....	225
7.2.8	Parameter Group for Data Transmission.....	225
7.3	Communication Protocol.....	226
7.3.1	LS INV 485 Protocol.....	226
7.3.2	Modbus-RTU Protocol.....	232
7.4	Compatible Common Area Parameter.....	235
7.5	S100 Expansion Common Area Parameter.....	238
7.5.1	Monitoring Area Parameter (Read Only).....	238
7.5.2	Control Area Parameter (Read/ Write).....	243
7.5.3	Inverter Memory Control Area Parameter (Read and Write).....	245
8	Table of Functions.....	249
8.1	Operation Group.....	249
8.2	Drive group (PAR→dr).....	251
8.3	Basic Function group (PAR→bA).....	256
8.4	Expanded Function group (PAR→Ad).....	261

8.5	Control Function group (PAR→Cn).....	266
8.6	Input Terminal Block Function group (PAR→In).....	271
8.7	Output Terminal Block Function group (PAR→OU).....	276
8.8	Communication Function group (PAR→CM)	280
8.9	Application Function group (PAR→AP).....	285
8.10	Protection Function group (PAR→Pr)	288
8.11	2nd Motor Function group (PAR→M2).....	293
8.12	User Sequence group (US).....	295
8.13	User Sequence Function group(UF)	298
8.14	Groups for LCD Keypad Only.....	318
8.14.1	Trip Mode (TRP Last-x).....	318
8.14.2	Config Mode (CNF).....	318
9	Troubleshooting	323
9.1	Trips and Warnings	323
9.1.1	Fault Trips	323
9.1.2	Warning Messages	326
9.2	Troubleshooting Fault Trips.....	327
9.3	Troubleshooting Other Faults	329
10	Maintenance.....	335
10.1	Regular Inspection Lists	335
10.1.1	Daily Inspections	335
10.1.2	Annual Inspections	336
10.1.3	Bi-annual Inspections	338
10.2	Storage and Disposal.....	338
10.2.1	Storage	338
10.2.2	Disposal.....	339
11	Technical Specification	341
11.1	Input and Output Specification	341
11.2	Product Specification Details	346
11.3	External Dimensions (IP 20 Type)	348
11.4	Peripheral Devices.....	354

Table of Contents

11.5 Fuse and Reactor Specifications355

11.6 Terminal Screw Specification.....356

11.7 Braking Resistor Specification358

11.8 Continuous Rated Current Derating.....359

11.9 Heat Emmission361

Product Warranty363

Index371

1 Preparing the Installation

This chapter provides details on product identification, part names, correct installation and cable specifications. To install the inverter correctly and safely, carefully read and follow the instructions.

1.1 Product Identification

The S100 Inverter is manufactured in a range of product groups based on drive capacity and power source specifications. Product name and specifications are detailed on the rating plate. The illustration on the next page shows the location of the rating plate. Check the rating plate before installing the product and make sure that the product meets your requirements. For more detailed product specifications, refer to [11.1 Input and Output Specification](#) on page 341.

Note

Check the product name, open the packaging, and then confirm that the product is free from defects. Contact your supplier if you have any issues or questions about your product.

LSLV0055S100-4EOFNS

INPUT 380-480V 3 Phase 50/60Hz
 HD: 11.0A, ND: 14.7A

OUTPUT 0-Input V 3 Phase 0.01-400Hz
 HD: 12A, ND: 16A
 9.1kVA

Ser. No 55025310146
 Inspected by D. K. YU
 KCC-REM-LSR-XXXXXXX

LSIs Made in KOREA

CE

UL LISTED IND. CONT. EQ. 8724

Model name

Power source specifications

Output specifications

LSLV 0055 S100 - 4EOFNS

Motor capacity

0004 - 0.4KW	0055 - 5.5KW
0008 - 0.75KW	0075 - 7.5KW
0015 - 1.5KW	0110 - 11KW
0022 - 2.2KW	0150 - 15KW
0037 - 3.7KW	0185 - 18.5KW
0040 - 4.0KW	0220 - 22KW

Series name

Input voltage

- 1 - Single phase 200V
- 2 - 3-phase 200V
- 4 - 3-phase 400V

Keypad

- E - LED Keypad

UL Type

- O - UL Open Type

EMC filter

- F - Built-in EMC
- N - Non-EMC

Reactor

- N - Non-Reactor

I/O

- M - 3.5mm
- S - 5mm

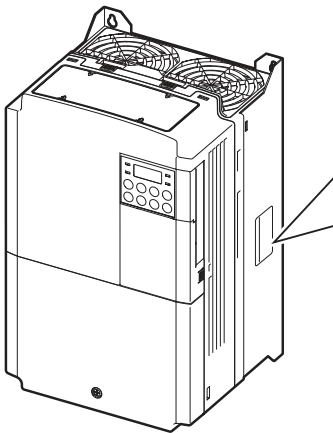

1.2 Part Names

The illustration below displays part names. Details may vary between product groups.

0.4~2.2kW (Single Phase) and 0.4~4.0kW (3-Phase)

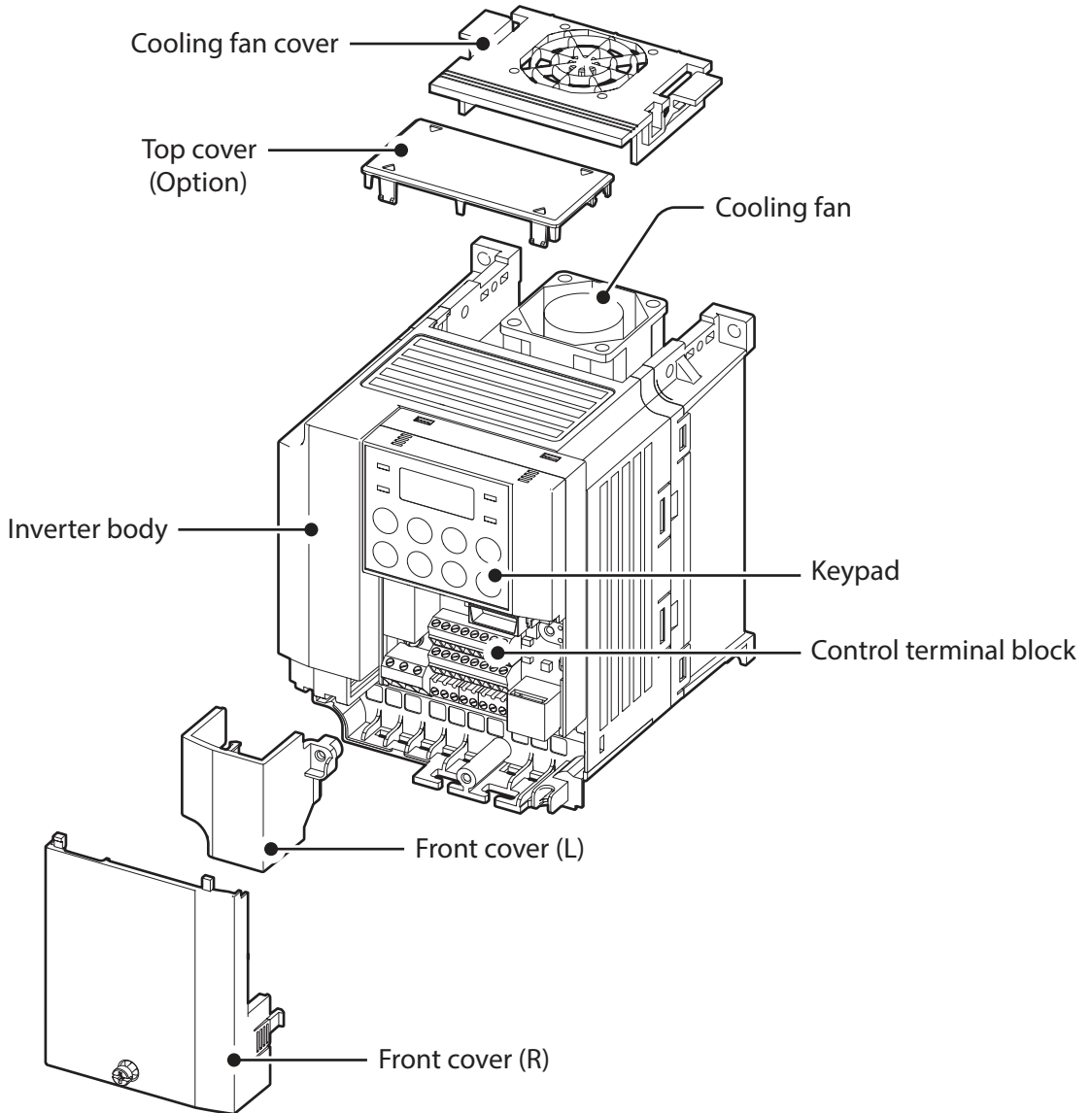

5.5-22kW(3-Phase)

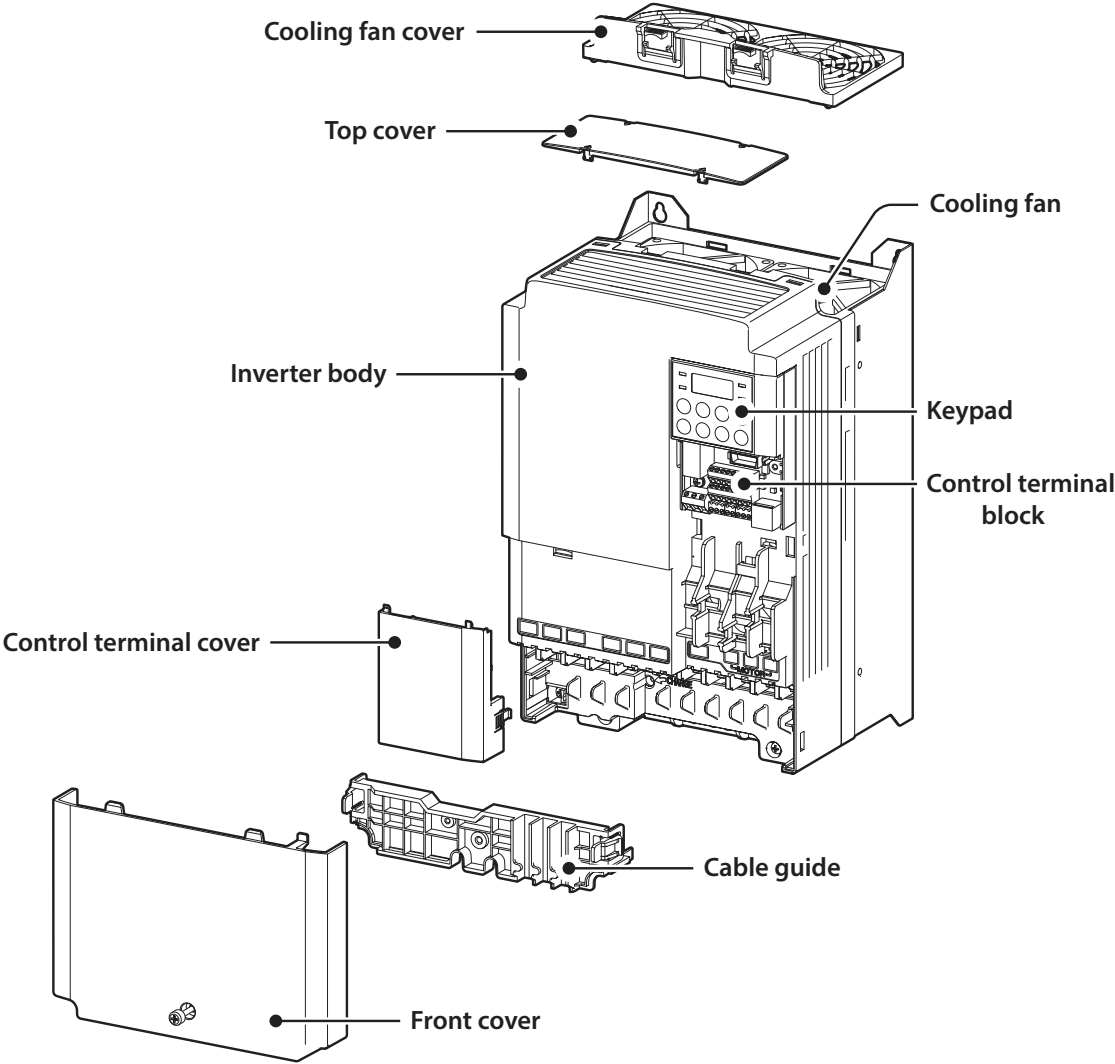

1.3 Installation Considerations

Inverters are composed of various precision, electronic devices, and therefore the installation environment can significantly impact the lifespan and reliability of the product. The table below details the ideal operation and installation conditions for the inverter.

Items	Description
Ambient Temperature*	Heavy Duty: 14–104°F (-10–50°C) Normal Duty: 14–122°F (-10– 40°C)
Ambient Humidity	90% relative humidity (no condensation)
Storage Temperature	- 4–149°F (-20–65°C)
Environmental Factors	An environment free from corrosive or flammable gases, oil residue or dust
Altitude/Vibration	Lower than 3,280 ft (1,000 m) above sea level/less than 1G (9.8m/sec ²)
Air Pressure	70 –106kPa

* The ambient temperature is the temperature measured at a point 2" (5 cm) from the surface of the inverter.

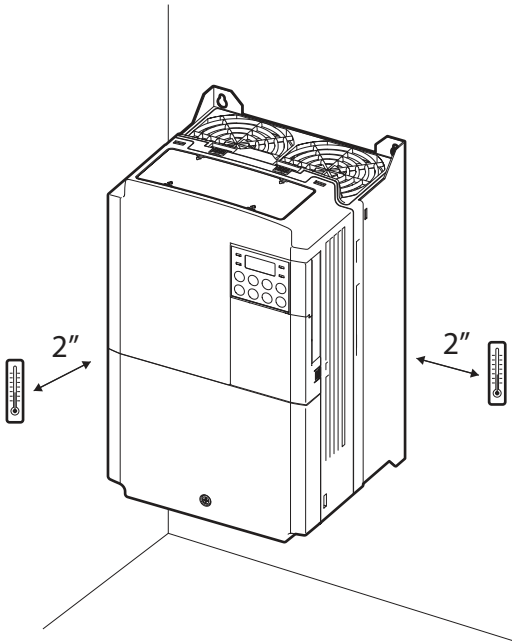

Caution

Do not allow the ambient temperature to exceed the allowable range while operating the inverter.

1.4 Selecting and Preparing a Site for Installation

When selecting an installation location consider the following points:

- The inverter must be installed on a wall that can support the inverter's weight.
- The location must be free from vibration. Vibration can adversely affect the operation of the inverter.
- The inverter can become very hot during operation. Install the inverter on a surface that is fire-resistant or flame-retardant and with sufficient clearance around the inverter to allow air to circulate. The illustrations below detail the required installation clearances.

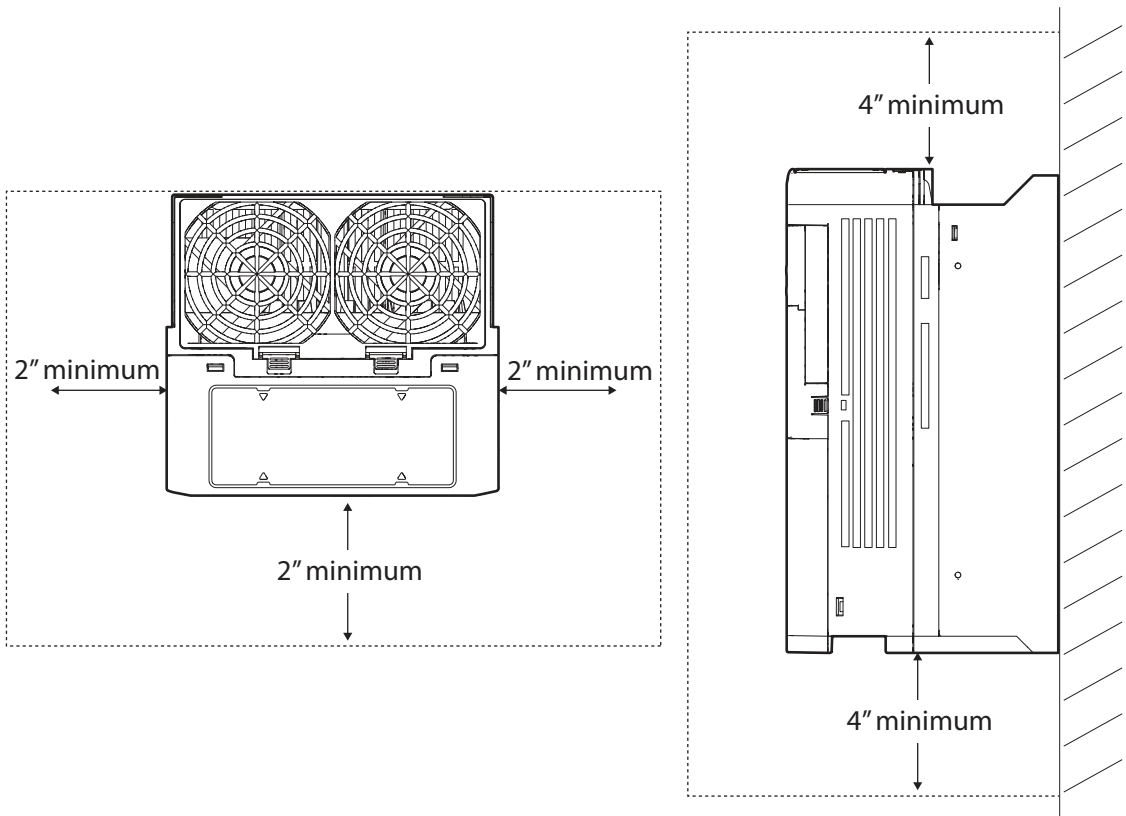

- Ensure sufficient air circulation is provided around the inverter when it is installed. If the inverter is to be installed inside a panel, enclosure, or cabinet rack, carefully consider the position of the inverter's cooling fan and the ventilation louver. The cooling fan must be positioned to efficiently transfer the heat generated by the operation of the inverter.

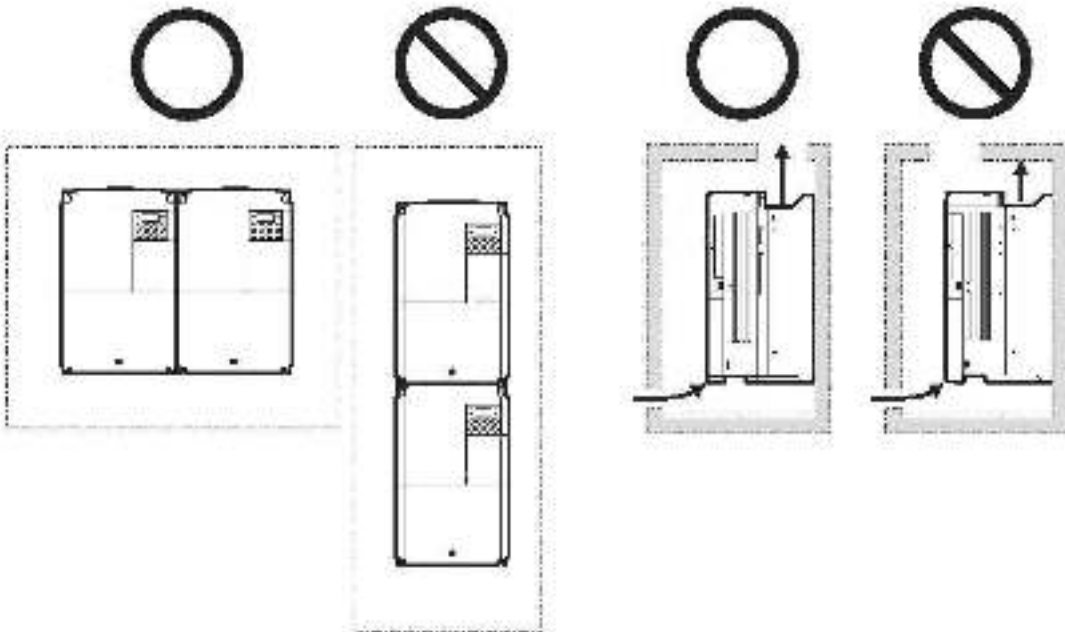

Preparing the Installation

- If you are installing multiple inverters in one location, arrange them side-by-side and remove the top covers. The top covers **MUST** be removed for side-by-side installations. Use a flat head screwdriver to remove the top covers.

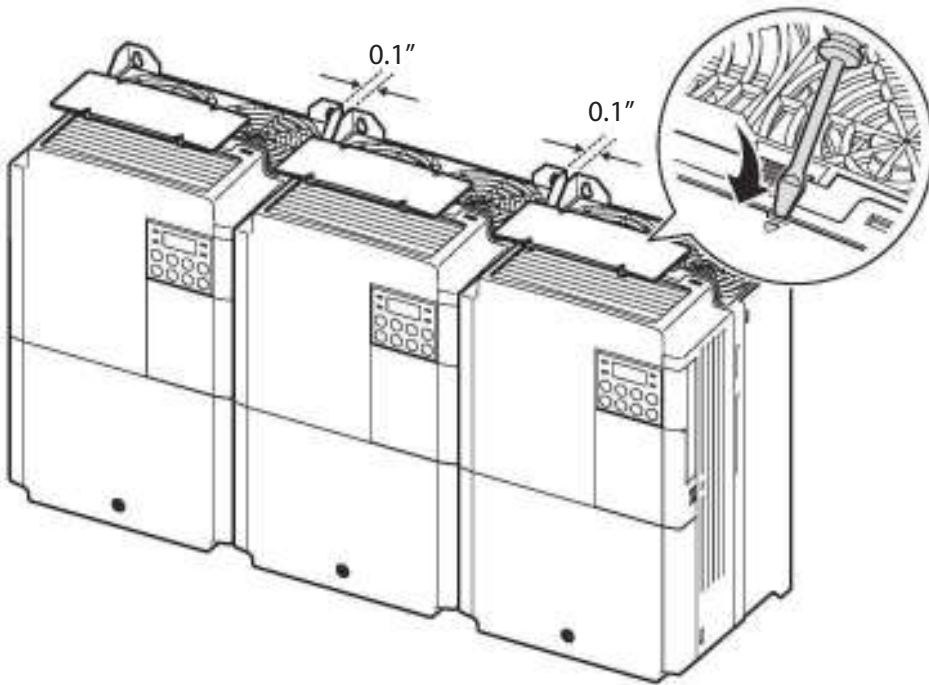

- If you are installing multiple inverters, of different ratings, provide sufficient clearance to meet the clearance specifications of the larger inverter.

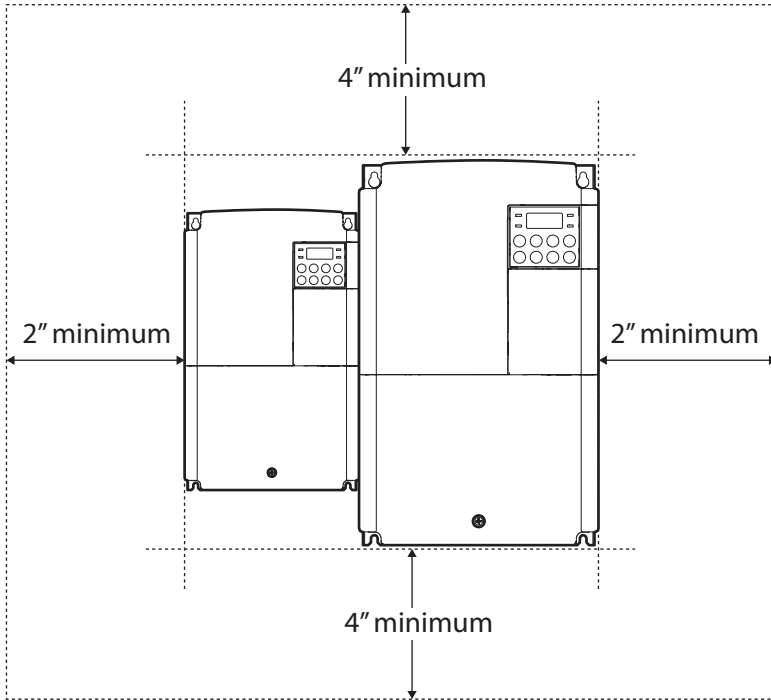

1.5 Cable Selection

When you install power and signal cables in the terminal blocks, only use cables that meet the required specification for the safe and reliable operation of the product. Refer to the following information to assist you with cable selection.

Caution

- Wherever possible use cables with the largest cross-sectional area for mains power wiring, to ensure that voltage drop does not exceed 2%.
- Use copper cables rated for 600V, 75°C for power terminal wiring.
- Use copper cables rated for 300V, 75°C for control terminal wiring.

Ground Cable and Power Cable Specifications

Load (kW)		Ground		Power I/O					
		mm ²	AWG	mm ²		AWG			
				R/S/T	U/V/W	R/S/T	U/V/W		
Single Phase 200V	0.4	3.5	12	2	2	14	14		
	0.75								
	1.5			3.5	3.5	12	12		
	2.2								
3-Phase 200V	0.4	3.5	12	2	2	14	14		
	0.75								
	1.5			3.5	3.5	12	12		
	2.2								
	3.7	5.5	10	6	6	10	10		
	4								
	5.5	14	6	10	10	8	8		
	7.5								
	11			16	16	6	6		
	15								
3-Phase 400V	0.4	2	14	2	2	14	14		
	0.75								
	1.5			3.5	12	2.5	2.5	14	14
	2.2								
	3.7	8	8	4	4	12	12		
	4								
	5.5			6	6	10	10		
	7.5								
	11	14	6	10	10	8	8		
	15								
	18.5								
	22								

Signal (Control) Cable Specifications

Terminals	Signal Cable			
	Without Crimp Terminal Connectors (Bare wire)		With Crimp Terminal Connectors (Bootlace Ferrule)	
	mm ²	AWG	mm ²	AWG
P1~P7*/CM/VR/V1/I2 /AO/Q1/EG/24/TI/TO* /SA,SB,SC/S+,S-,SG	0.75	18	0.5	20
A1/B1/C1	1.0	17	1.5	15

* Standard I/O doesn't support P6/P7/TI/TO terminal. Refer to [Step 4 Control Terminal Wiring](#) on page [27](#).

2 Installing the Inverter

This chapter describes the physical and electrical installation methods, including mounting and wiring of the product. Refer to the flowchart and basic configuration diagram provided below to understand the procedures and installation methods to be followed to install the product correctly.

Installation Flowchart

The flowchart lists the sequence to be followed during installation. The steps cover equipment installation and testing of the product. More information on each step is referenced in the steps.

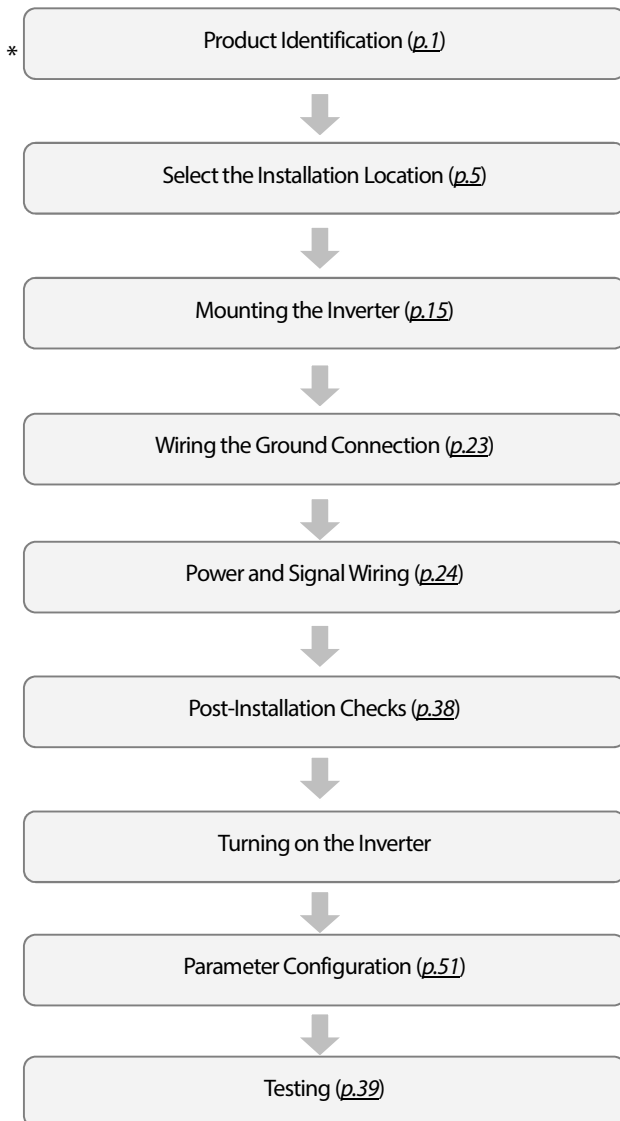

Basic Configuration Diagram

The reference diagram below shows a typical system configuration showing the inverter and peripheral devices.

Prior to installing the inverter, ensure that the product is suitable for the application (power rating, capacity, etc). Ensure that all of the required peripherals and optional devices (resistor brakes, contactors, noise filters, etc.) are available. For more details on peripheral devices, refer to [11.4 Peripheral Devices](#) on page [354](#).

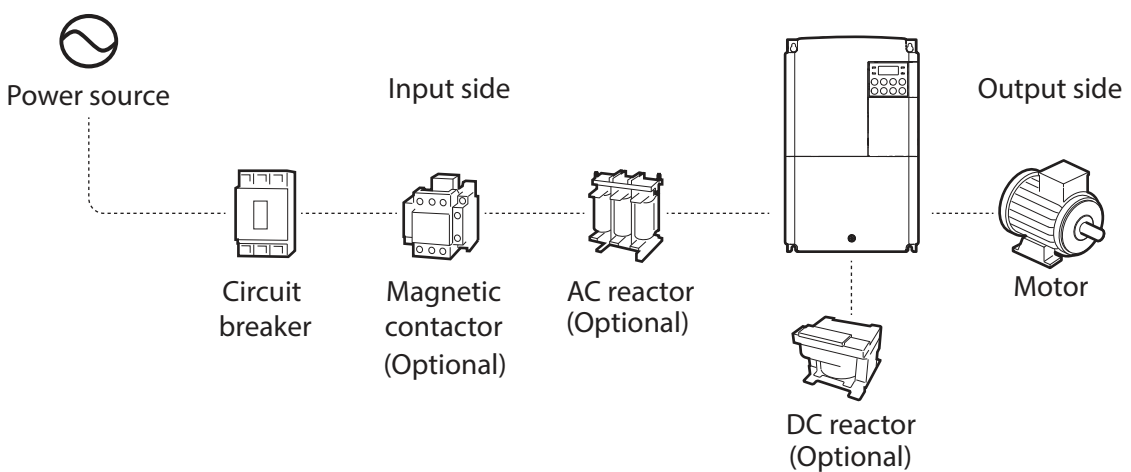

Caution

- Figures in this manual are shown with covers or circuit breakers removed to show a more detailed view of the installation arrangements. Install covers and circuit breakers before operating the inverter. Operate the product according to the instructions in this manual.
- Do not start or stop the inverter using a magnetic contactor, installed on the input power supply.
- If the inverter is damaged and loses control, the machine may cause a dangerous situation. Install an additional safety device such as an emergency brake to prevent these situations.
- High levels of current draw during power-on can affect the system. Ensure that correctly rated circuit breakers are installed to operate safely during power-on situations.
- Reactors can be installed to improve the power factor. Note that reactors may be installed within 30 ft (9.14 m) from the power source if the input power exceeds 10 times of inverter capacity. Refer to [11.5 Fuse and Reactor Specifications](#) on page [355](#) and carefully select a reactor that meets the requirements.

2.1 Mounting the Inverter

Mount the inverter on a wall or inside a panel following the procedures provided below. Before installation, ensure that there is sufficient space to meet the clearance specifications, and that there are no obstacles impeding the cooling fan's air flow.

Select a wall or panel suitable to support the installation. Refer to [11.3 External Dimensions \(IP 20 Type\)](#) on page [348](#) and check the inverter's mounting bracket dimensions.

- 1 Use a level to draw a horizontal line on the mounting surface, and then carefully mark the fixing points.
- 2 Drill the two upper mounting bolt holes, and then install the mounting bolts. Do not fully tighten the bolts at this time. Fully tighten the mounting bolts after the inverter has been mounted.

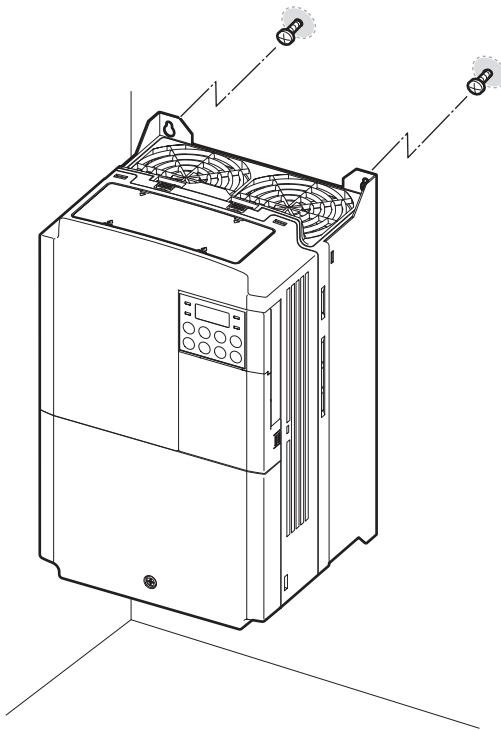

- 3 Mount the inverter on the wall or inside a panel using the two upper bolts, and then fully tighten the mounting bolts. Ensure that the inverter is placed flat on the mounting surface, and that the installation surface can securely support the weight of the inverter.

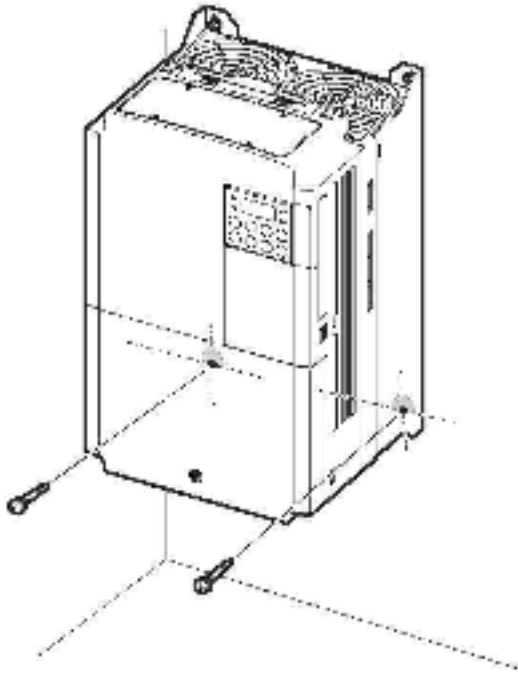

Note

The quantity and dimensions of the mounting brackets vary based on frame size. Refer to [11.3 External Dimensions \(IP 20 Type\)](#) on page 348 for detailed information about your model.

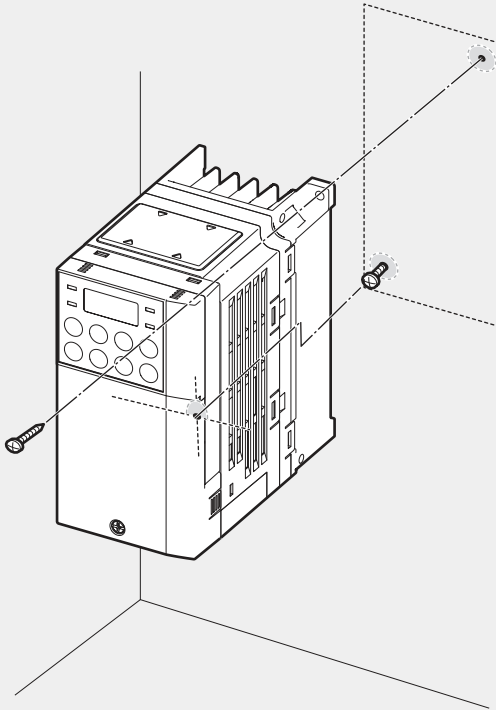

Inverters with small frames (0.4-0.8kW) have only two mounting brackets. Inverters with large frames have 4 mounting brackets.

⚠ Caution

- Do not transport the inverter by lifting with the inverter's covers or plastic surfaces. The inverter may tip over if covers break, causing injuries or damage to the product. Always support the inverter using the metal frames when moving it.
- Hi-capacity inverters are very heavy and bulky. Use an appropriate transport method that is suitable for the weight.
- Do not install the inverter on the floor or mount it sideways against a wall. The inverter **MUST** be installed vertically, on a wall or inside a panel, with its rear flat on the mounting surface.

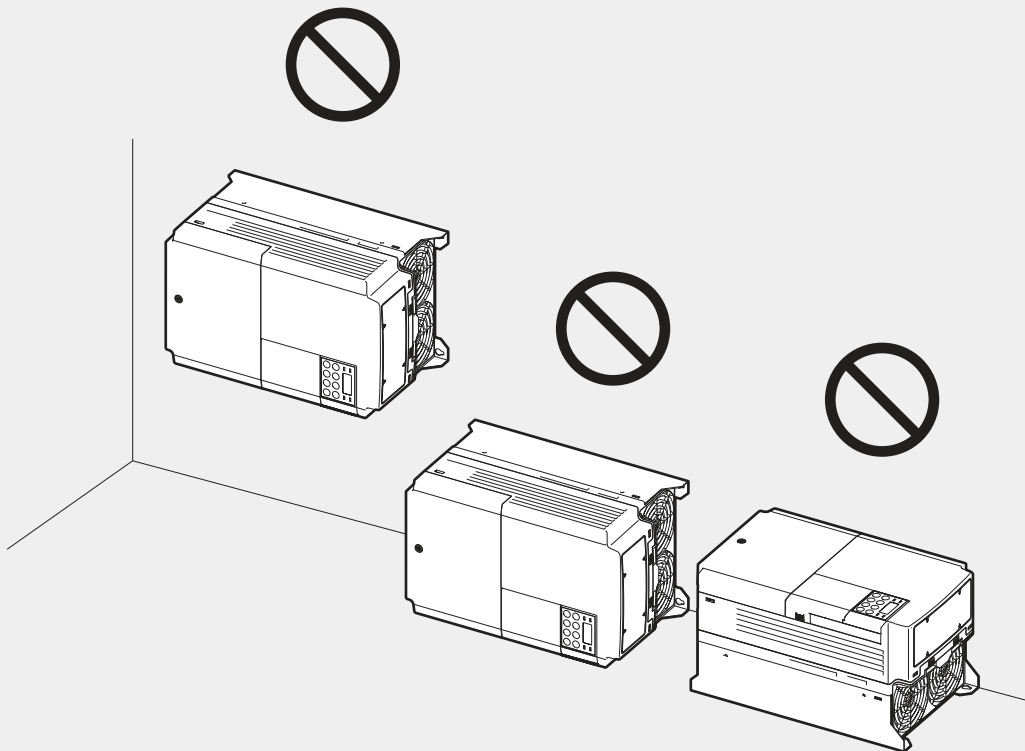

2.2 Cable Wiring

Open the front cover, remove the cable guides and control terminal cover, and then install the ground connection as specified. Complete the cable connections by connecting an appropriately rated cable to the terminals on the power and control terminal blocks.

Read the following information carefully before carrying out wiring connections to the inverter. All warning instructions must be followed.

Caution

- Install the inverter before carrying out wiring connections.
- Ensure that no small metal debris, such as wire cut-offs, remain inside the inverter. Metal debris in the inverter may cause inverter failure.
- Tighten terminal screws to their specified torque. Loose terminal block screws may allow the cables to disconnect and cause short circuit or inverter failure. Refer to [11.6 Terminal Screw Specification](#) on page 356 for torque specifications.
- Do not place heavy objects on top of electric cables. Heavy objects may damage the cable and result in electric shock.
- Use cables with the largest cross-sectional area, appropriate for power terminal wiring, to ensure that voltage drop does not exceed 2%.
- Use copper cables rated at 600V, 75 °C for power terminal wiring.
- Use copper cables rated at 300V, 75 °C for control terminal wiring.
- If you need to re-wire the terminals due to wiring-related faults, ensure that the inverter keypad display is turned off and the charge lamp under the front cover is off before working on wiring connections. The inverter may hold a high voltage electric charge long after the power supply has been turned off.

Step 1 Front Cover, Control Terminal Cover and Cable Guide

The front cover, control terminal cover and cable guide must be removed to install cables. Refer to the following procedures to remove the covers and cable guide. The steps to remove these parts may vary depending on the inverter model.

0.8-1.5kW (single phase), 1.5-2.2kW (3-phase)

- 1 Loosen the bolt that secures the front cover (right side). Push and hold the latch on the right side of the cover. Then remove the cover by lifting it from the bottom and moving it away from the front of the inverter.

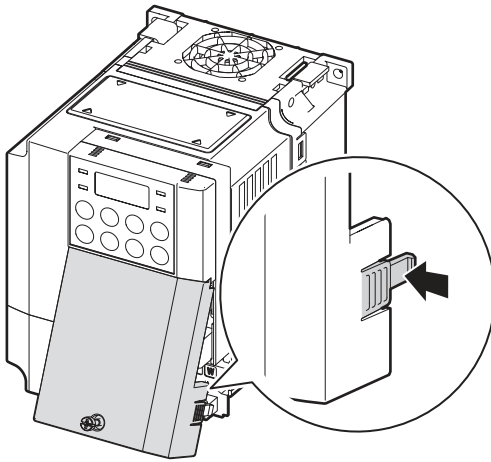

- 2 Remove the bolt that secures the front cover (left side) (1). Push and hold the latch on the left side of the cover. Then remove the cover by lifting it from the bottom and moving it away from the front of the inverter (2).

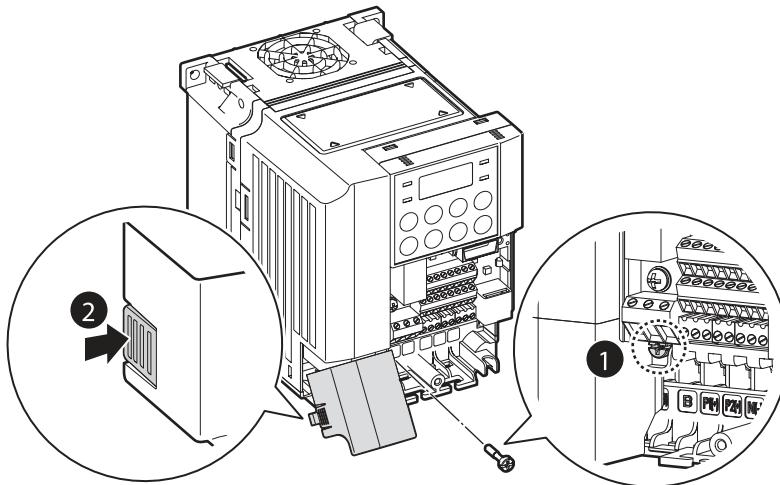

- 3 Connect the cables to the power terminals and the control terminals. For cable specifications, refer to [1.5 Cable Selection](#) on page [10](#).

5.5-22kW (3-phase)

- 1 Loosen the bolt that secures the front cover. Then remove the cover by lifting it from the bottom and away from the front.

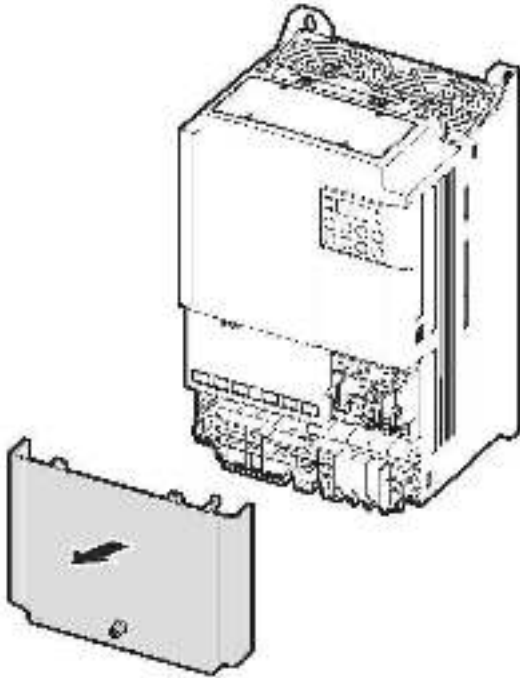

- 2 Push and hold the levers on both sides of the cable guide (❶) and then remove the cable guide by pulling it directly away from the front of the inverter (❷). In some models where the cable guide is secured by a bolt, remove the bolt first.

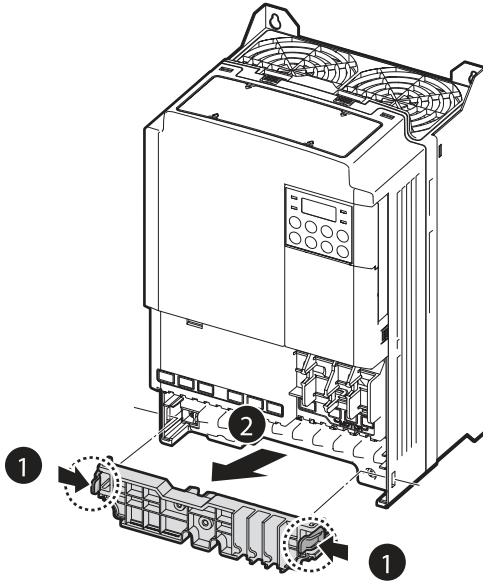

- 3 Push and hold the tab on the right side of the control terminal cover. Then remove the cover by lifting it from the bottom and moving it away from the front of the inverter.

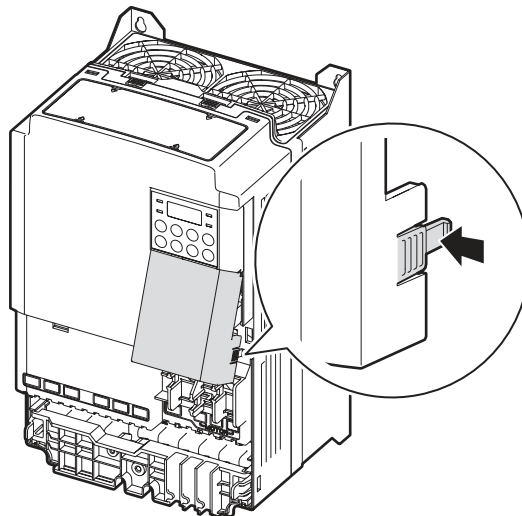

- 4 Connect the cables to the power terminals and the control terminals. For cable specifications, refer to [1.5 Cable Selection](#) on page [10](#).

Note

To connect an LCD keypad, remove the plastic knock-out from the bottom of the front cover (right side) or from the control terminal cover. Then connect the signal cable to the RJ-45 port on the control board.

Step 2 Ground Connection

Remove the front cover(s), cable guide, and the control terminal cover. Then follow the instructions below to install the ground connection for the inverter.

- 1 Locate the ground terminal and connect an appropriately rated ground cable to the terminals. Refer to [1.5 Cable Selection](#) on page [10](#) to find the appropriate cable specification for your installation.

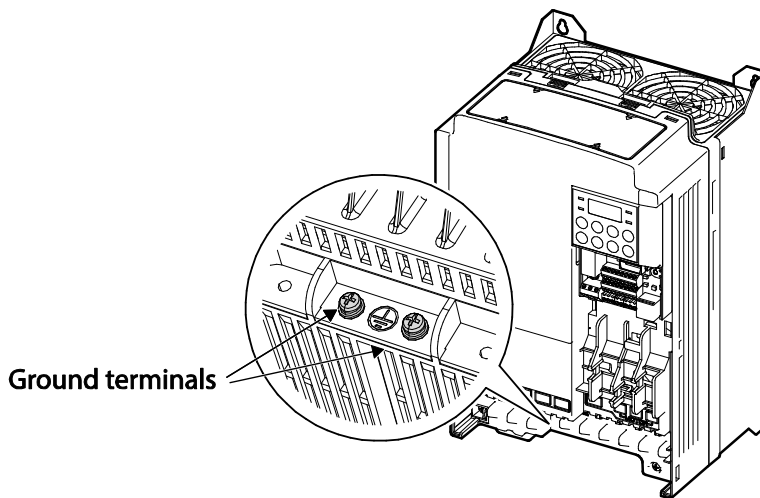

- 2 Connect the other ends of the ground cables to the supply earth (ground) terminal.

Note

- 200 V products require Class 3 grounding. Resistance to ground must be $< 100\Omega$.
- 400 V products require Special Class 3 grounding. Resistance to ground must be $< 10\Omega$.

Warning

Install ground connections for the inverter and the motor by following the correct specifications to ensure safe and accurate operation. Using the inverter and the motor without the specified grounding connections may result in electric shock.

Step 3 Power Terminal Wiring

The following illustration shows the terminal layout on the power terminal block. Refer to the detailed descriptions to understand the function and location of each terminal before making wiring connections. Ensure that the cables selected meet or exceed the specifications in [1.5 Cable Selection](#) on page [10](#) before installing them.

Caution

- Tighten terminal screws to their specified torque. Loose terminal screws may allow the cables to disconnect and cause short circuit or inverter failure. Over tightening terminal screws may damage the terminals and cause short circuits and malfunctions.
- Use copper cables rated for 600V, 75°C for power terminal wiring.
- Use copper cables rated for 300V, 75°C for control terminal wiring.
- Power supply cables must be connected to the R, S, and T terminals. Connecting power cables to the U, V, and W terminals will cause internal damage to the inverter. Connect motors to the U, V, and W terminals. Phase sequence arrangement is not necessary.

Attention

- Appliquer des couples de marche aux vis des bornes. Des vis desserrées peuvent provoquer des courts-circuits et des dysfonctionnements. Ne pas trop serrer la vis, car cela risque d'endommager les bornes et de provoquer des courts-circuits et des dysfonctionnements.
- Utiliser uniquement des fils de cuivre avec une valeur nominale de 600 V, 75 °C pour le câblage de la borne d'alimentation, et une valeur nominale de 300 V, 75 °C pour le câblage de la borne de commande.
- Les câblages de l'alimentation électrique doivent être connectés aux bornes R, S et T. Leur connexion aux bornes U, V et W provoque des dommages internes à l'onduleur. Le moteur doit être raccordé aux bornes U, V et W. L'arrangement de l'ordre de phase n'est pas nécessaire.

0.4kW (single phase), 0.4~0.8kW (3-phase)

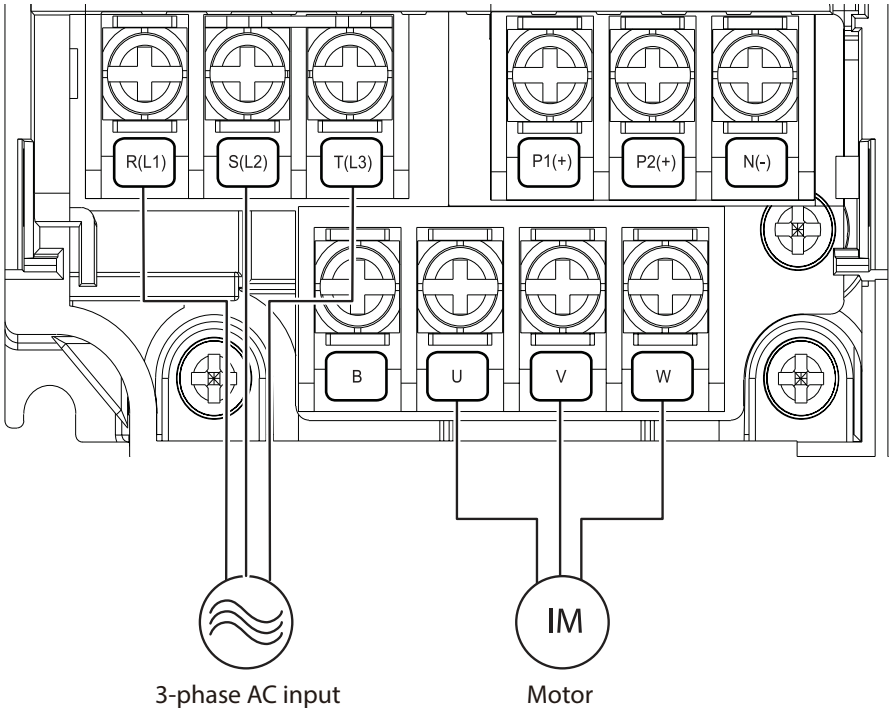

0.8-2.2kW (single phase), 1.5-4.0kW (3-phase)

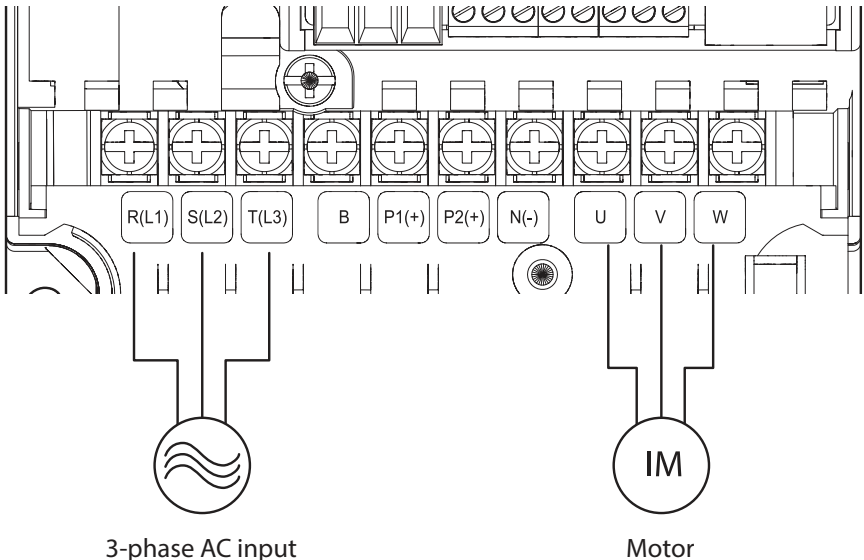

5.5-22kW (3-phase)

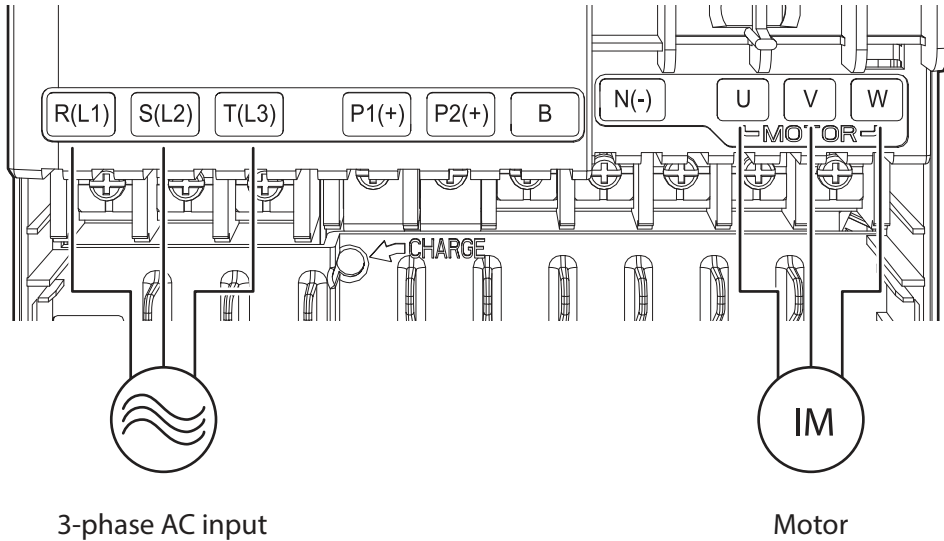

Power Terminal Labels and Descriptions

Terminal Labels	Name	Description
R(L1)/S(L2)/T(L3)	AC power input terminal	Mains supply AC power connections.
P2(+)/N(-)	DC link terminal	DC voltage terminals.
P1(+)/P2(+)	DC reactor terminal	DC reactor wiring connection. (When you use the DC reactor, must remove short-bar)
P2(+)/B	Brake resistor terminals	Brake resistor wiring connection.
U/V/W	Motor output terminals	3-phase induction motor wiring connections.

Note

- Use STP (Shielded Twisted Pair) cables to connect a remotely located motor with the inverter. Do not use 3 core cables.
- Make sure that the total cable length does not exceed 665ft (202m). For inverters $\leq 4.0\text{kW}$ capacity, ensure that the total cable length does not exceed 165ft (50m).
- Long cable runs can cause reduced motor torque in low frequency applications due to voltage drop. Long cable runs also increase a circuit's susceptibility to stray capacitance and may trigger over-current protection devices or result in malfunction of equipment connected to the inverter.
- Voltage drop is calculated by using the following formula:

$$\text{Voltage Drop (V)} = [\sqrt{3} \times \text{cable resistance (m}\Omega\text{/m)} \times \text{cable length (m)} \times \text{current(A)}] / 1000$$
- Use cables with the largest possible cross-sectional area to ensure that voltage drop is minimized

over long cable runs. Lowering the carrier frequency and installing a micro surge filter may also help to reduce voltage drop.

Distance	< 165ft (50m)	< 330ft (100m)	> 330ft (100m)
Allowed Carrier Frequency	< 15 kHz	< 5 kHz	< 2.5 kHz

Warning

Do not connect power to the inverter until installation has been fully completed and the inverter is ready to be operated. Doing so may result in electric shock.

Caution

- Power supply cables must be connected to the R, S, and T terminals. Connecting power cables to other terminals will damage the inverter.
- Use insulated ring lugs when connecting cables to R/S/T and U/V/W terminals.
- The inverter's power terminal connections can cause harmonics that may interfere with other communication devices located near to the inverter. To reduce interference the installation of noise filters or line filters may be required.
- To avoid circuit interruption or damaging connected equipment, do not install phase-advanced condensers, surge protection, or electronic noise filters on the output side of the inverter.
- To avoid circuit interruption or damaging connected equipment, do not install magnetic contactors on the output side of the inverter.

Step 4 Control Terminal Wiring

The illustrations below show the detailed layout of control wiring terminals, and control board switches. Refer to the detailed information provided below and [1.5 Cable Selection](#) on page 10 before installing control terminal wiring and ensure that the cables used meet the required specifications.

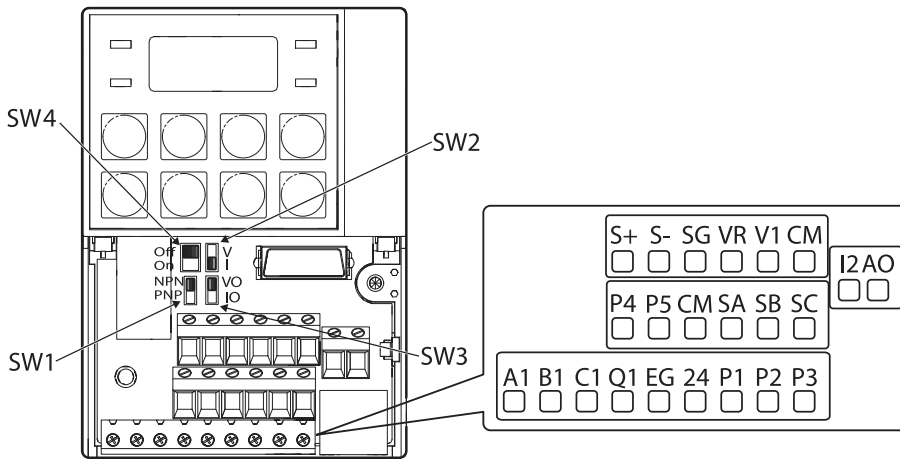

<Standard I/O>

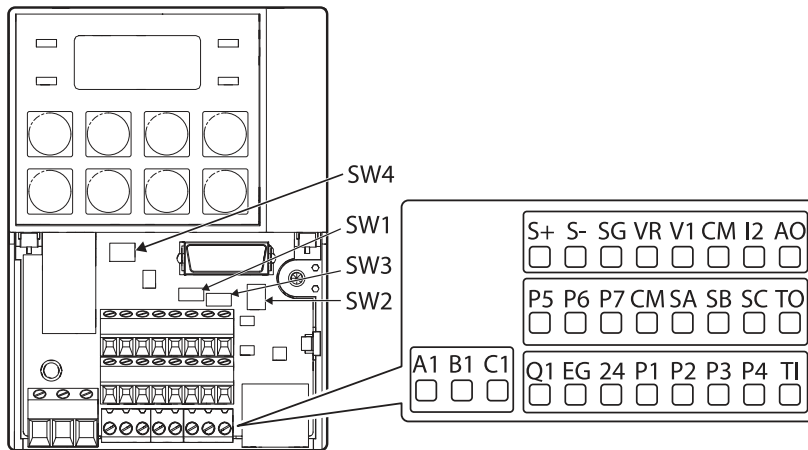

<Multiple I/O>

Control Board Switches

Switch	Description
SW1	NPN/PNP mode selection switch
SW2	analog voltage/current input terminal selection switch
SW3	analog voltage/current output terminal selection switch
SW4	Terminating Resistor selection switch

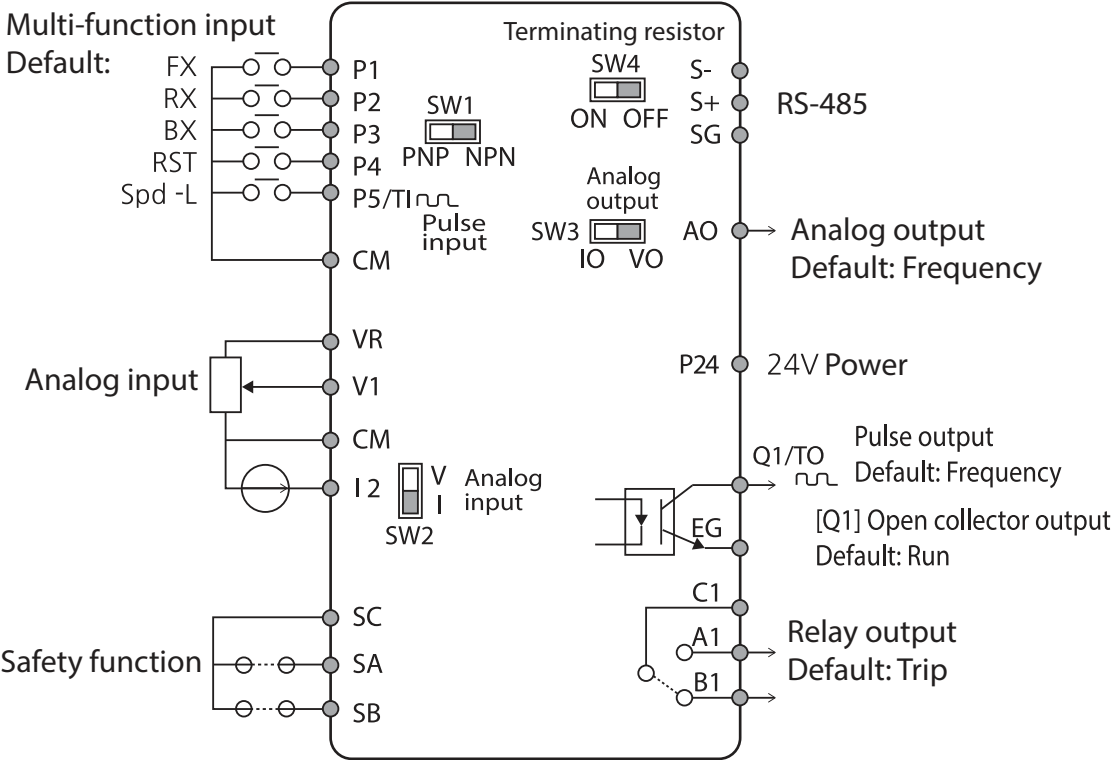

<Standard I/O>

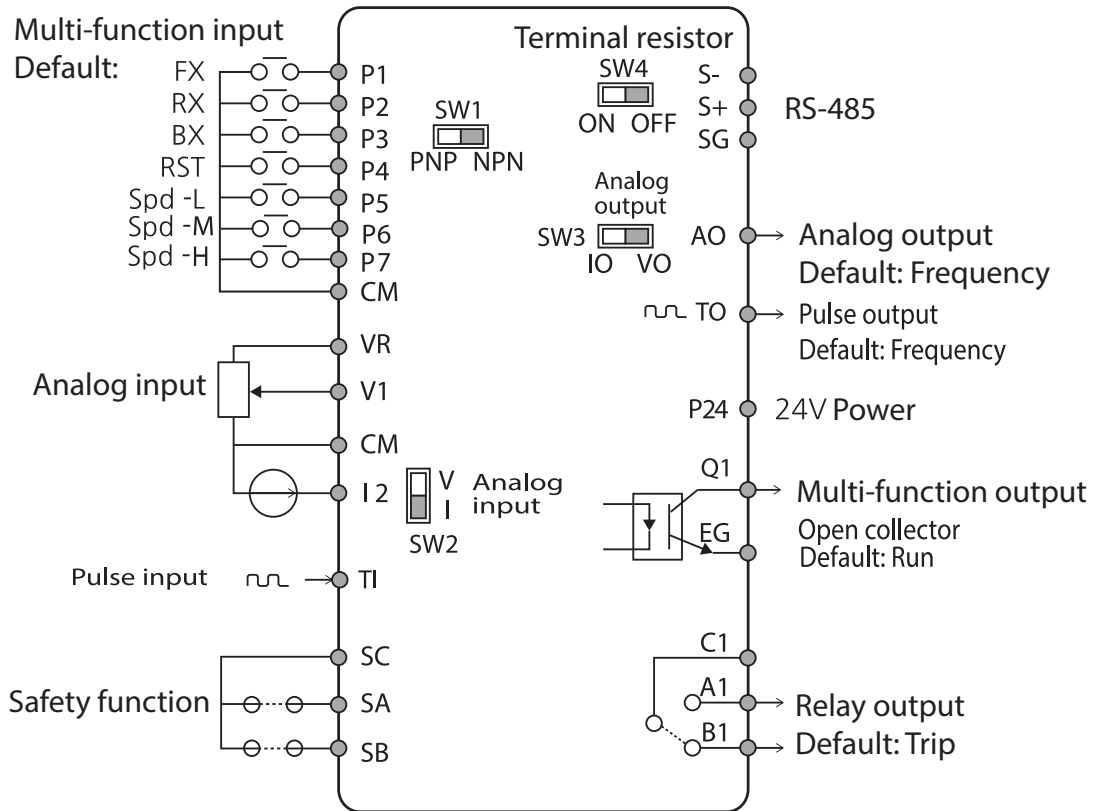

<Multiple I/O>

Input Terminal Labels and Descriptions

Function	Label	Name	Description
Multi-function terminal configuration	P1-P7	Multi-function Input 1-7	Configurable for multi-function input terminals. Factory default terminals and setup are as follows: <ul style="list-style-type: none"> • P1: Fx • P2: Rx • P3: BX • P4: RST • P5: Speed-L • P6: Speed-M • P7: Speed-H Standard I/O is only provided for P5.
	CM	Common Sequence	Common terminal for analog terminal inputs and outputs.
Analog input configuration	VR	Potentiometer frequency reference input	Used to setup or modify a frequency reference via analog voltage or current input. <ul style="list-style-type: none"> • Maximum Voltage Output: 12V

Function	Label	Name	Description
			<ul style="list-style-type: none"> Maximum Current Output: 100mA, Potentiometer: 1–5kΩ
	V1	Voltage input for frequency reference input	Used to setup or modify a frequency reference via analog voltage input terminal. <ul style="list-style-type: none"> Unipolar: 0–10V (12V Max.) Bipolar: -10–10V (±12V Max.)
	I2	Voltage/current input for frequency reference input	Used to setup or modify a frequency reference via analog voltage or current input terminals. Switch between voltage (V2) and current (I2) modes using a control board switch (SW2). <p>V2 Mode:</p> <ul style="list-style-type: none"> Unipolar: 0–10V (12V Max.) <p>I2 Mode</p> <ul style="list-style-type: none"> Input current: 4–20mA Maximum Input current: 24mA Input resistance: 249Ω
	TI	Pulse input for frequency reference input (pulse train)	Setup or modify frequency references using pulse inputs from 0 to 32kHz. <ul style="list-style-type: none"> Low Level: 0–0.8V High Level: 3.5–12V (In case of Standard I/O, Pulse input TI and Multi-function terminal P5 share the same terminal. Set the In.69 P5 Define to 54(TI)).
Safety functionality configuration	SA	Safety input A	Used to block the output from the inverter in an emergency.
	SB	Safety input B	Conditions: <ul style="list-style-type: none"> Normal Operation: Both the SA and SB terminals are connected to the SC terminal. Output Block: One or both of the SA and SB terminals lose connection with the SC terminal.
	SC	Safety input power source	DC 24V, < 25mA

Output/Communication Terminal Labels and Descriptions

Function	Label	Name	Description
Analog output	AO	Voltage/Current Output	Used to send inverter output information to external devices: output frequency, output current, output voltage, or a DC voltage. Operate switch (SW3) to select the signal output type (voltage or current) at the AO terminal.

Function	Label	Name	Description
			<p>Output Signal Specifications:</p> <ul style="list-style-type: none"> • Output voltage: 0–10V • Maximum output voltage/current: 12V/10mA • Output current: 0–20mA • Maximum output current: 24mA • Factory default output: Frequency
	TO	Pulse Output	<p>Sends pulse signals to external devices to provide a single output value from the inverter of either: output frequency, output current, output voltage, or DC voltage.</p> <p>Output Signal Specifications:</p> <ul style="list-style-type: none"> • Output frequency: 0–32kHz • Output voltage: 0–12V • Factory default output: Frequency <p>(In case of Standard I/O, Pulse output TO and Multi-function output Q1 share the same terminal. Set the OU.33Q1 Define to 38(TO).)</p>
Digital output	Q1	Multi-functional (open collector)	DC 26V, 100mA or less Factory default output: Run
	EG	Common	Common ground contact for an open collector (with external power source)
	24	External 24V power source	Maximum output current: 150mA
	A1/C1/B1	Fault signal output	<p>Sends out alarm signals when the inverter's safety features are activated (AC 250V < 1A, DC 30V < 1A).</p> <ul style="list-style-type: none"> • Fault condition: A1 and C1 contacts are connected (B1 and C1 open connection) • Normal operation: B1 and C1 contacts are connected (A1 and C1 open connection)
Communication	S+/S-/SG	RS-485 signal line	Used to send or receive RS-485 signals. Refer to 7. RS-485 Communication Features on page 219 for more details.

Preinsulated Crimp Terminal Connectors (Bootlace Ferrule) .

Use preinsulated crimp terminal connectors to increase reliability of the control terminal wiring. Refer to the specifications below to determine the crimp terminals to fit various cable sizes.

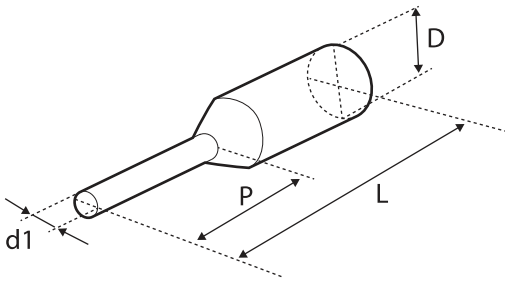

P/N	Cable Spec.		Dimensions (inches/mm)				Manufacturer
	AWG	mm ²	L*	P	d1	D	
CE002506	26	0.25	10.4	0.4 / 6.0	0.04 / 1.1	0.1 / 2.5	JEONO (Jeono Electric, http://www.jeono.com/)
CE002508			12.4	0.5 / 8.0			
CE005006	22	0.50	12.0	0.45 / 6.0	0.05 / 1.3	0.125 / 3.2	
CE007506	20	0.75	12.0	0.45 / 6.0	0.06 / 1.5	0.13 / 3.4	

* If the length (L) of the crimp terminals exceeds 0.5" (12.7mm) after wiring, the control terminal cover may not close fully.

To connect cables to the control terminals without using crimp terminals, refer to the following illustration detailing the correct length of exposed conductor at the end of the control cable.

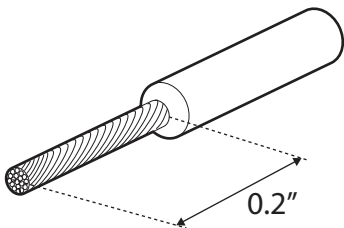

Note

- While making wiring connections at the control terminals, ensure that the total cable length does not exceed 165ft (50m).
- Ensure that the length of any safety related wiring does not exceed 100ft (30m).
- Ensure that the cable length between an LCD keypad and the inverter does not exceed 10ft (3.04m). Cable connections longer than 10ft (3.04m) may cause signal errors.
- Use ferrite material to protect signal cables from electro-magnetic interference.
- Take care when supporting cables using cable ties, to apply the cable ties no closer than 6 inches from the inverter. This provides sufficient access to fully close the front cover.
- When making control terminal cable connections, use a small flat-tip screw driver (0.1in wide (2.5mm) and 0.015in thick (0.4mm) at the tip).

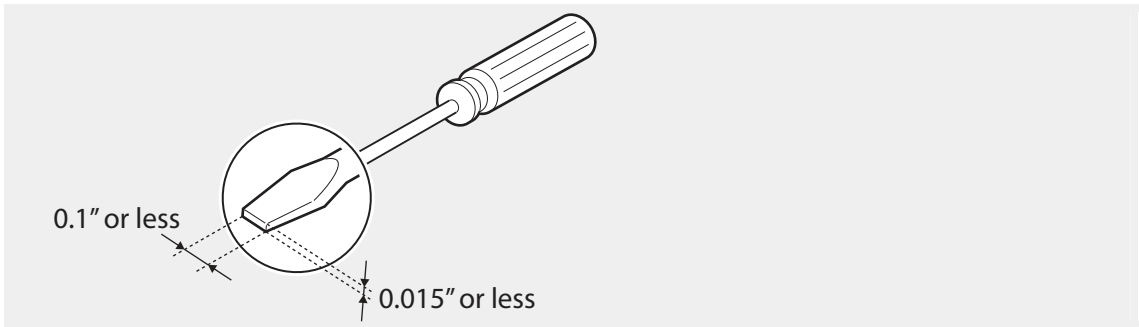

Step 5 PNP/NPN Mode Selection

The S100 inverter supports both PNP (Source) and NPN (Sink) modes for sequence inputs at the terminal. Select an appropriate mode to suit requirements using the PNP/NPN selection switch (SW1) on the control board. Refer to the following information for detailed applications.

PNP Mode (Source)

Select PNP using the PNP/NPN selection switch (SW1). Note that the factory default setting is NPN mode. CM is the common ground terminal for all analog inputs at the terminal, and P24 is 24V internal source. If you are using an external 24V source, build a circuit that connects the external source (-) and the CM terminal.

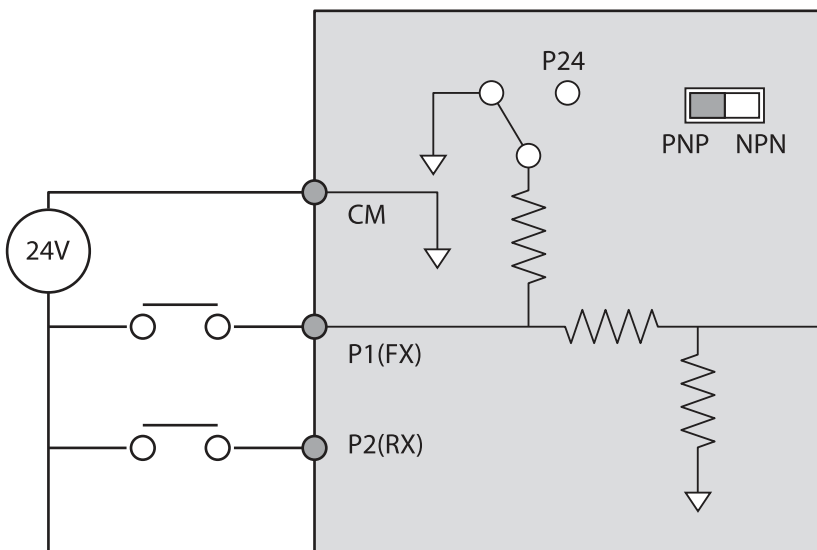

NPN Mode (Sink)

Select NPN using the PNP/NPN selection switch (SW1). Note that the factory default setting is NPN mode. CM is the common ground terminal for all analog inputs at the terminal, and P24 is 24V internal source.

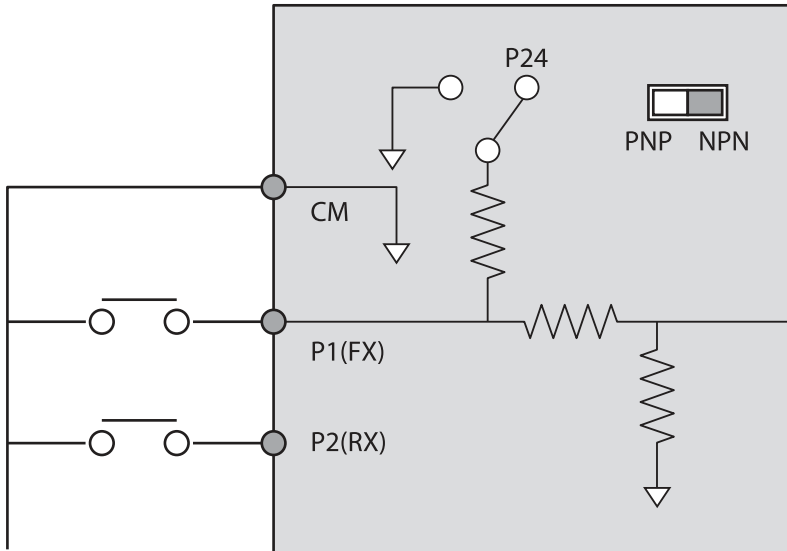

Step 6 Disabling the EMC Filter for Power Sources with Asymmetrical Grounding

EMC filter is built in the next two products. S100 200V single-phase built-in EMC filter and the 400V class. An EMC filter prevents electromagnetic interference by reducing radio emissions from the inverter. EMC filter use is not always recommended, as it increases leakage current. If an inverter uses a power source with an asymmetrical grounding connection, the EMC filter **MUST** be turned off.

Asymmetrical Grounding Connection			
One phase of a delta connection is grounded	<p>A delta connection with three phases labeled R(L1), S(L2), and T(L3). The S(L2) phase is connected to a ground symbol.</p>	Intermediate grounding point on one phase of a delta connection	<p>A delta connection with three phases labeled R(L1), S(L2), and T(L3). The S(L2) phase has a tap point connected to a ground symbol.</p>

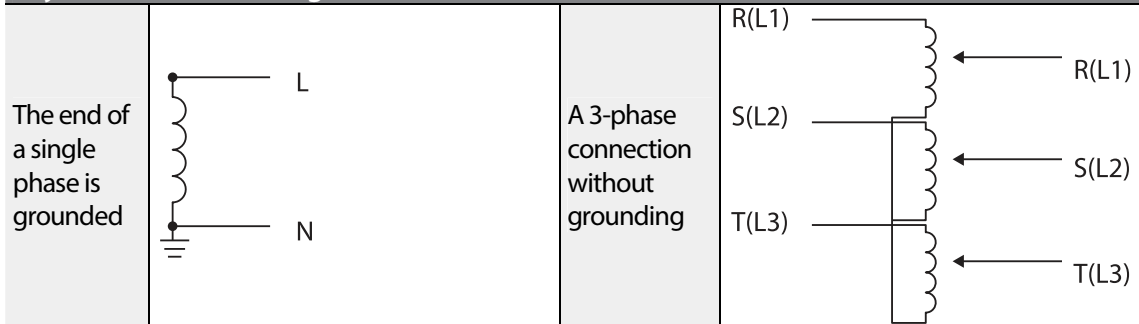

Asymmetrical Grounding Connection



Caution

- Do not activate the EMC filter if the inverter uses a power source with an asymmetrical grounding structure, for example a grounded delta connection. Personal injury or death by electric shock may result.
- Wait at least 10 minutes before opening the covers and exposing the terminal connections. Before starting work on the inverter, test the connections to ensure all DC voltage has been fully discharged. Personal injury or death by electric shock may result.

Before using the inverter, confirm the power supply's grounding system. Disable the EMC filter if the power source has an asymmetrical grounding connection. Refer to the figures below to locate the EMC filter on/off terminal and replace the metal bolt with the plastic bolt. If the EMC filter is required in the future, reverse the steps and replace the plastic bolt with the metal bolt to reconnect the EMC filter.

Steel bolt	Plastic bolt
	
EMC ON	EMC OFF

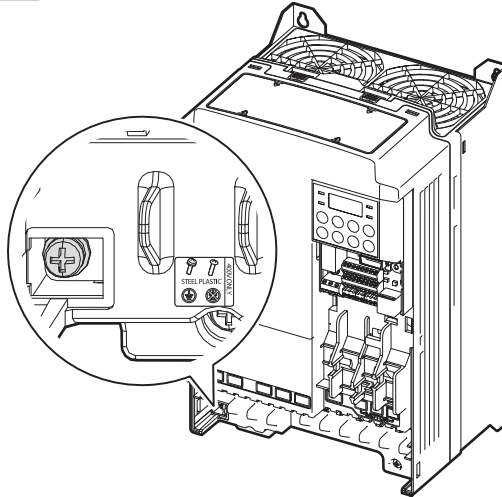

Step 7 Re-assembling the Covers and Routing Bracket

Re-assemble the cable routing bracket and the covers after completing the wiring and basic configurations. Note that the assembly procedure may vary according to the product group or frame size of the product.

2.3 Post-Installation Checklist

After completing the installation, check the items in the following table to make sure that the inverter has been safely and correctly installed.

Items	Check Point	Ref.	Result
Installation Location/Power I/O Verification	Is the installation location appropriate?	<u>p.5</u>	
	Does the environment meet the inverter's operating conditions?	<u>p.6</u>	
	Does the power source match the inverter's rated input?	<u>p.341</u>	
	Is the inverter's rated output sufficient to supply the equipment? (Degraded performance will result in certain circumstances. Refer to <i>11.8 Continuous Rated Current Derating</i> on page <i>359</i> for details.)	<u>p.341</u>	
Power Terminal Wiring	Is a circuit breaker installed on the input side of the inverter?	<u>p.14</u>	
	Is the circuit breaker correctly rated?	<u>p.341</u>	
	Are the power source cables correctly connected to the R/S/T terminals of the inverter? (Caution: connecting the power source to the U/V/W terminals may damage the inverter.)	<u>p.24</u>	
	Are the motor output cables connected in the correct phase rotation (U/V/W)? (Caution: motors will rotate in reverse direction if three phase cables are not wired in the correct rotation.)	<u>p.24</u>	
	Are the cables used in the power terminal connections correctly rated?	<u>p.10</u>	
	Is the inverter grounded correctly?	<u>p.23</u>	
	Are the power terminal screws and the ground terminal screws tightened to their specified torques?	<u>p.24</u>	
	Are the overload protection circuits installed correctly on the motors (if multiple motors are run using one inverter)?	-	
	Is the inverter separated from the power source by a magnetic contactor (if a braking resistor is in use)?	<u>p.14</u>	
	Are advanced-phase capacitors, surge protection and electromagnetic interference filters installed correctly? (These devices MUST not be installed on the output side of the inverter.)	<u>p.24</u>	
Control Terminal Wiring	Are STP (shielded twisted pair) cables used for control terminal wiring?	-	
	Is the shielding of the STP wiring properly grounded?	-	
	If 3-wire operation is required, are the multi-function input terminals defined prior to the installation of the control wiring connections?	<u>p.27</u>	

Items	Check Point	Ref.	Result
	Are the control cables properly wired?	<u>p.27</u>	
	Are the control terminal screws tightened to their specified torques?	<u>p.19</u>	
	Is the total cable length of all control wiring < 165ft (100m)?	<u>p.33</u>	
	Is the total length of safety wiring < 100ft (30m)?	<u>p.33</u>	
Miscellaneous	Are optional cards connected correctly?	-	
	Is there any debris left inside the inverter?	<u>p.19</u>	
	Are any cables contacting adjacent terminals, creating a potential short circuit risk?	-	
	Are the control terminal connections separated from the power terminal connections?	-	
	Have the capacitors been replaced if they have been in use for > 2 years?	-	
	Have the fans been replaced if they have been in use for > 3 years?	-	
	Has a fuse been installed for the power source?	<u>p.355</u>	
	Are the connections to the motor separated from other connections?	-	

Note

STP (Shielded Twisted Pair) cable has a highly conductive, shielded screen around twisted cable pairs. STP cables protect conductors from electromagnetic interference.

2.4 Test Run

After the post-installation checklist has been completed, follow the instructions below to test the inverter.

- 1 Turn on the power supply to the inverter. Ensure that the keypad display light is on.
- 2 Select the command source.
- 3 Set a frequency reference, and then check the following:
 - If V1 is selected as the frequency reference source, does the reference change according to the input voltage at VR?
 - If V2 is selected as the frequency reference source, is the voltage/current selector switch (SW2) set to voltage, and does the reference change according to the input voltage?

- If I2 is selected as the frequency reference source, is the voltage/current selector switch (SW2) set to current, and does the reference change according to the input current?
- 4 Set the acceleration and deceleration time.
 - 5 Start the motor and check the following:
 - Ensure that the motor rotates in the correct direction (refer to the note below).
 - Ensure that the motor accelerates and decelerates according to the set times, and that the motor speed reaches the frequency reference.

Note

If the forward command (Fx) is on, the motor should rotate counterclockwise when viewed from the load side of the motor. If the motor rotates in the reverse direction, switch the cables at the U and V terminals.

Remarque

Si la commande avant (Fx) est activée, le moteur doit tourner dans le sens anti-horaire si on le regarde côté charge du moteur. Si le moteur tourne dans le sens inverse, inverser les câbles aux bornes U et V.

Verifying the Motor Rotation

- 1 On the keypad, set the drv (Frequency reference source) code in the Operation group to 0 (Keypad).
- 2 Set a frequency reference.
- 3 Press the [RUN] key. Motor starts forward operation.
- 4 Observe the motor's rotation from the load side and ensure that the motor rotates counterclockwise (forward).

If the motor rotates in the reverse direction, two of the U/V/W terminals need to be switched.

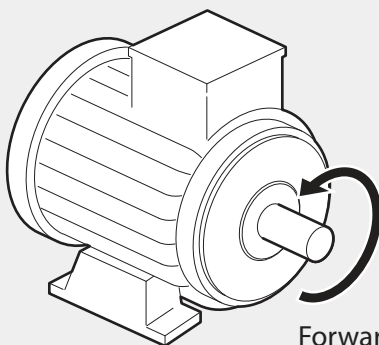

Forward operation

Caution

- Check the parameter settings before running the inverter. Parameter settings may have to be adjusted depending on the load.
- To avoid damaging the inverter, do not supply the inverter with an input voltage that exceeds the rated voltage for the equipment.
- Before running the motor at maximum speed, confirm the motor's rated capacity. As inverters can be used to easily increase motor speed, use caution to ensure that motor speeds do not accidentally exceed the motor's rated capacity.

3 Learning to Perform Basic Operations

This chapter describes the keypad layout and functions. It also introduces parameter groups and codes, required to perform basic operations. The chapter also outlines the correct operation of the inverter before advancing to more complex applications. Examples are provided to demonstrate how the inverter actually operates.

3.1 About the Keypad

The keypad is composed of two main components – the display and the operation (input) keys. Refer to the following illustration to identify part names and functions.

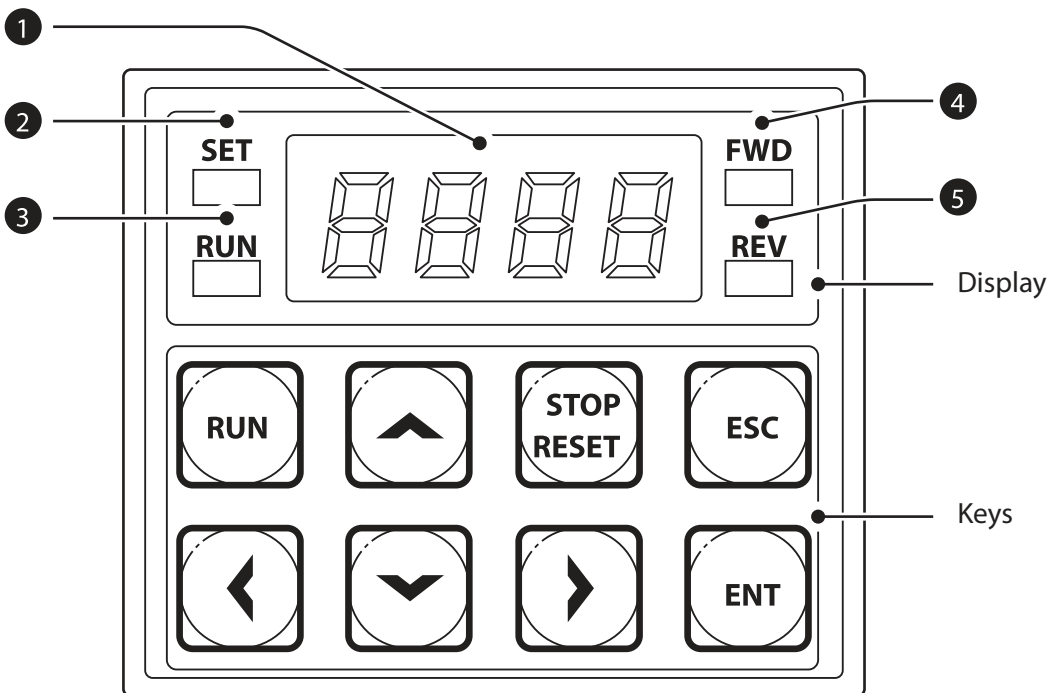

3.1.1 About the Display

The following table lists display part names and their functions.







No.	Name	Function
①	7-Segment Display	Displays current operational status and parameter information.
②	SET Indicator	LED flashes during parameter configuration and when the ESC key operates as the multi-function key.
③	RUN Indicator	LED turns on (steady) during an operation, and flashes during acceleration or deceleration.
④	FWD Indicator	LED turns on (steady) during forward operation.
⑤	REV Indicator	LED turns on (steady) during reverse operation.

The table below lists the way that the keypad displays characters (letters and numbers).

0	0	A	A	K	K	U	U
1	1	b	B	L	L	v	V
2	2	C	C	m	M	W	W
3	3	d	D	n	N	X	X
4	4	E	E	O	O	Y	Y
5	5	F	F	P	P	Z	Z
6	6	G	G	Q	Q	-	-
7	7	H	H	R	R	-	-
8	8	I	I	S	S	-	-
9	9	J	J	T	T	-	-

3.1.2 Operation Keys

The following table lists the names and functions of the keypad's operation keys.

Key	Name	Description
	[RUN] key	Used to run the inverter (inputs a RUN command).
	[STOP/RESET] key	STOP: stops the inverter. RESET: resets the inverter following fault or failure condition.
	[▲] key, [▼] key	Switch between codes, or to increase or decrease parameter values.
	[◀] key, [▶] key	Switch between groups, or to move the cursor during parameter setup or modification.
	[ENT] key	Used to select, confirm, or save a parameter value.
	[ESC] key	A multi-function key used to configure different functions, such as: <ul style="list-style-type: none"> • Jog operation • Remote/Local mode switching • Cancellation of an input during parameter setup

Caution

Install a separate emergency stop switch in the circuit. The [STOP/RESET] key on the keypad works only when the inverter has been configured to accept an input from the keypad.

3.1.3 Control Menu

The S100 inverter control menu uses the following groups.

Group	Display	Description
Operation	-	Configures basic parameters for inverter operation. These include reference frequencies and acceleration or deceleration times. Frequencies will only be displayed if an LCD keypad is in use.
Drive	dr	Configures parameters for basic operations. These include jog operation, motor capacity evaluation, torque boost, and other keypad related parameters.
Basic	bA	Configures basic parameters, including motor-related parameters and multi-step frequencies.
Advanced	Ad	Configure acceleration or deceleration patterns and to setup frequency limits.
Control	Ln	Configures sensorless vector - related features.
Input Terminal	In	Configures input terminal-related features, including digital multi-functional inputs and analog inputs.
Output Terminal	OU	Configures output terminal-related features such as relays and analog outputs.
Communication	Co	Configures communication features for RS-485 or other communication options.
Application	AP	Configures PID control-related sequences and operations.
Protection	Pr	Configures motor or inverter protection features.
Motor 2 (Secondary Motor)	M2	Configures secondary motor related features. The secondary motor (M2) group appears on the keypad only when one of the multi-function input terminals (In.65–In.71) has been set to 26 (Secondary motor).
User Sequence	US	Used to implement simple sequences with various function blocks.
User Sequence Function	UF	

3.2 Learning to Use the Keypad

The keypad enables movement between groups and codes. It also enables users to select and configure functions. At code level, you can set parameter values to turn on or off specific functions, or decide how the functions will be used. Refer to 8 *Table of Functions* on page 249 to find the functions you need.

Confirm the correct values (or the correct range of the values), and then follow the examples below to configure the inverter with the keypad.

3.2.1 Group and Code Selection

Follow the examples below to learn how to switch between groups and codes.

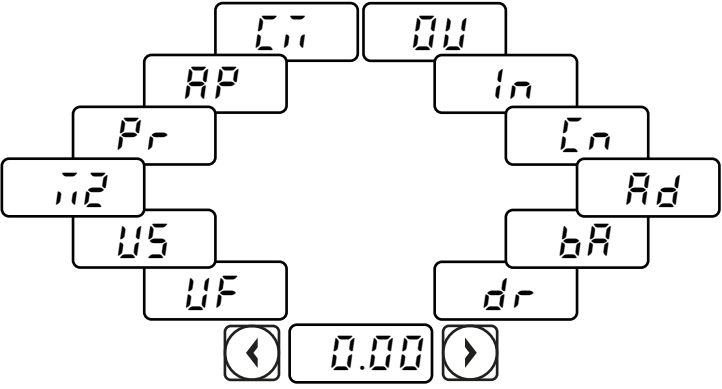
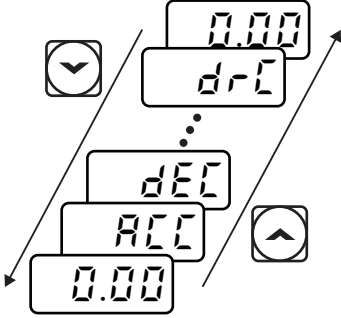
Step	Instruction	Keypad Display
1	Move to the group you want using the [◀] and [▶] keys.	
2	Move up and down through the codes using the [▲] and [▼] keys until you locate the code that you require.	
3	Press the [ENT] key to save the change.	-

Note

For some settings, pressing the [▲] or [▼] key will not increase or decrease the code number by 1. Code numbers may be skipped and not be displayed. This is because certain code numbers have been intentionally left blank (or reserved) for new functions to be added in the future. Also some features may have been hidden (disabled) because a certain code has been set to disable the functions for relevant codes.

As an example, if Ad.24 (Frequency Limit) is set to 0 (No), the next codes, Ad.25 (Freq Limit Lo) and Ad.26 (Freq Limit Hi), will not be displayed. If you set code Ad.24 to 1 (Yes) and enable the frequency limit feature, codes Ad.25 and 26 will appear to allow the maximum and minimum frequency limitations to be set up.

3.2.2 Navigating Directly to Different Codes

The following example details navigating to code dr. 95, from the initial code in the Drive group (dr. 0). This example applies to all groups whenever you would like to navigate to a specific code number.

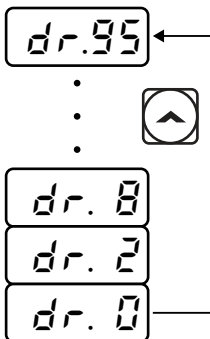

Step	Instruction	Keypad Display
1	Ensure that you are currently at the first code of the Drive group (dr.0).	
2	Press the [ENT] key. Number '9' will flash.	
3	Press the [▼] key to display '5,' the first 1s' place of the group destination, '95.'	
4	Press the [◀] key to move to the 10s' place. The cursor will move to the left and '05' will be displayed. This time, the number '0' will be flashing.	

Step	Instruction	Keypad Display
5	Press the [▲] key to increase the number from '0' to '9,' the 10s place digit of the destination, '95.'	
6	Press the [ENT] key. Code dr.95 is displayed.	

3.2.3 Setting Parameter Values

Enable or disable features by setting or modifying parameter values for different codes. Directly enter setting values, such as frequency references, supply voltages, and motor speeds. Follow the instructions below to learn to set or modify parameter values.

Step	Instruction	Keypad Display
1	Select the group and code to setup or modify parameter settings, and then press the [ENT] key. The first number on the right side of the display will flash.	
2	Press the [◀] or [▶] key to move the cursor to the number that you would like to modify.	
3	Press the [▲] or [▼] key to adjust the value, and then press the [ENT] key to confirm it. The selected value will flash on the display.	
4	Press the [ENT] key again to save the change.	-

Note

- A flashing number on the display indicates that the keypad is waiting for an input from the user. Changes will be saved when the [ENT] key is pressed while the number is flashing. The setting change will be canceled if you press any other key.
- Each code's parameter values have default features and ranges specified. Refer to 8 *Table of Functions* on page 249 for information about the features and ranges before setting or modifying parameter values.

3.2.4 Configuring the [ESC] Key

The [ESC] key is a multi-functional key that can be configured to carry out a number of different functions. Refer to 4.6 *Local/Remote Mode Switching* on page 82 for more information about the other functions of the [ESC] key. The following example shows how to configure the [ESC] key to perform a jog operation.

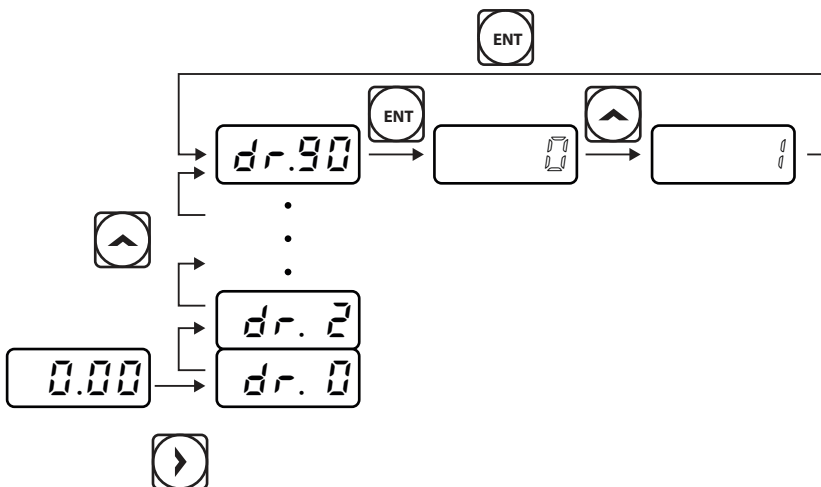

Step	Instruction	Keypad Display
1	Ensure that you are currently at the first code of the Operation group, and that code 0.00 (Command Frequency) is displayed.	0.00
2	Press the [▶] key. You have moved to the initial code of the Drive group (dr.0).	dr.0
3	Press the [▲] or [▼] key to select code 90 (ESC key configuration), and then press the [ENT] key.	dr.90

Step	Instruction	Keypad Display
	Code dr.90 currently has an initial parameter value of, 0 (adjust to the initial position).	
4	Press the [▲] key to modify the value to 1 (Jog key) and then press the [ENT] key. The new parameter value will flash.	
5	Press the [ENT] key again to save changes.	-

Note

- If the code dr. 90 (ESC key configuration) is set to 1 (JOG Key) or 2 (Local/Remote), the SET indicator will flash when the [ESC] key is pressed.
- The factory default setting for code dr. 90 is 0 (move to the initial position). You can navigate back to the initial position (code 0.00 of the Operation group) immediately, by pressing the [ESC] key while configuring any codes in any groups.

3.3 Actual Application Examples

3.3.1 Acceleration Time Configuration

The following is an example demonstrating how to modify the ACC (Acceleration time) code value (from 5.0 to 16.0) from the Operation group.

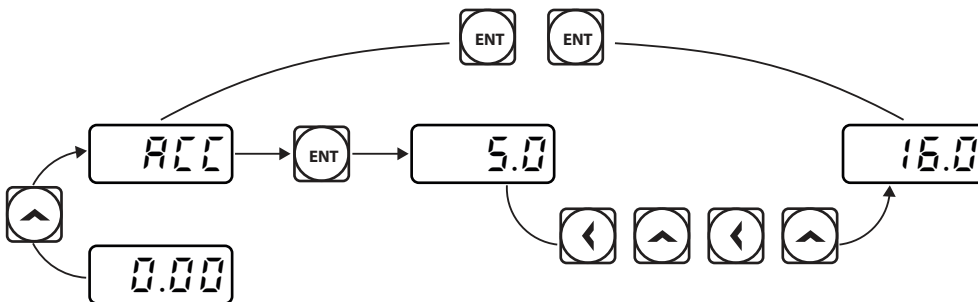

Step	Instruction	Keypad Display
1	Ensure that the first code of the Operation group is selected, and code 0.00 (Command Frequency) is displayed.	0.00
2	Press the [▲] key. The display will change to the second code in the Operation group, the ACC (Acceleration Time) code.	ACC
3	Press the [ENT] key. The number '5.0' will be displayed, with '0' flashing. This indicates that the current acceleration time is set to 5.0 seconds. The flashing value is ready to be modified by using the keypad.	5.0
4	Press the [◀] key to change the first place value. '5' will be flashing now. This indicates the flashing value, '5' is ready to be modified.	5.0
5	Press the [▲] key to change the number '5' into '6', the first place value of the target number '16.'	6.0
6	Press the [◀] key to move to the 10s, place value. The number in the 10s position, '0' in '06' will start to flash	06.0
7	Press the [▲] key to change the number from '0' to '1', to match the 10s place value of the target number '16,' and then press the [ENT] key. Both digits will flash on the display.	16.0
8	Press the [ENT] key once again to save changes. 'ACC' will be displayed. The change to the acceleration time setup has been completed.	ACC

3.3.2 Frequency Reference Configuration

The following is an example to demonstrate configuring a frequency reference of 30.05 (Hz) from the first code in the Operation group (0.00).



Step	Instruction	Keypad Display
1	Ensure that the first code of the Operation group is selected, and the code 0.00 (Command Frequency) is displayed.	
2	Press the [ENT] key. The value, 0.00 will be displayed with the '0' in the 1/100s place value flashing.	
3	Press the [◀] key 3 times to move to the 10s place value. The '0' at the 10s place value will start to flash.	
4	Press the [▲] key to change it to '3,' the 10s place value of the target frequency, '30.05.'	
5	Press the [▶] key 3 times. The '0' at the 1/100s place position will flash.	
6	Press the [▲] key to change it to '5,' the 1/100 place value of the target frequency, '30.05,' and then press the [ENT] key. The parameter value will flash on the display.	
7	Press the [ENT] key once again to save changes. Flashing stops. The frequency reference has been configured to 30.05 Hz.	

Note

- A flashing number on the display indicates that the keypad is waiting for an input from the user. Changes are saved when the [ENT] key is pressed while the value is flashing. Changes will be canceled if any other key is pressed.
- The S100 inverter keypad display can display up to 4 digits. However, 5-digit figures can be used and are accessed by pressing the [◀] or [▶] key, to allow keypad input.

3.3.3 Jog Frequency Configuration

The following example demonstrates how to configure Jog Frequency by modifying code 11 in the Drive group (Jog Frequency) from 10.00(Hz) to 20.00(Hz). You can configure the parameters for different codes in any other group in exactly the same way.

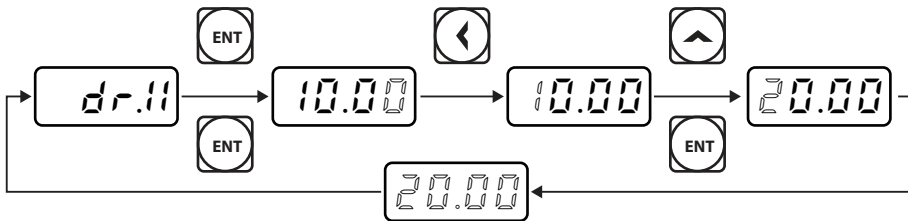

Step	Instruction	Keypad Display
1	Go to code 11(Jog Frequency) in the Drive group.	
2	Press the [ENT] key. The current Jog Frequency value (10.00) for code dr.11 is displayed.	
3	Press the [◀] key 3 times to move to the 10s place value. Number '1' at the 10s place position will flash.	
4	Press the [▲] key to change the value to '2,' to match the 10s place value of the target value'20.00,' and then press the [ENT] key. All parameter digits will flash on the display.	
5	Press the [ENT] key once again to save the changes. Code dr.11 will be displayed. The parameter change has been completed.	

3.3.4 Initializing All Parameters

The following example demonstrates parameter initialization using code dr.93 (Parameter Initialization) in the Drive group. Once executed, parameter initialization will delete all modified values for all codes and groups.

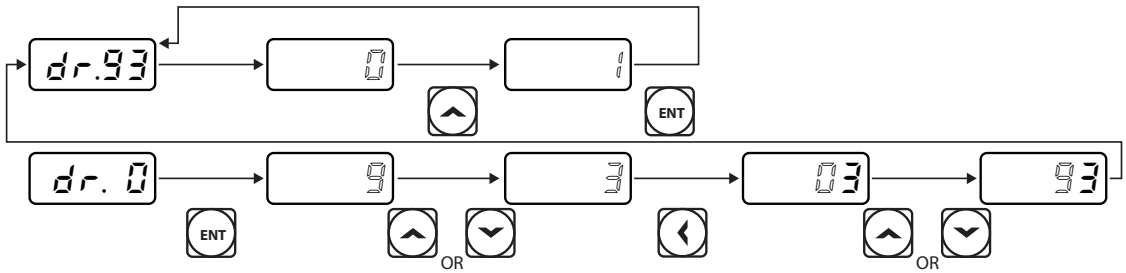

Step	Instruction	Keypad Display
1	Go to code 0 (Jog Frequency) in the Drive group.	<code>dr.0</code>
2	Press the [ENT] key. The current parameter value (9) will be displayed.	<code>9</code>
3	Press the [q] key to change the first place value to '3' of the target code, '93.'	<code>3</code>
4	Press the [◀] key to move to the 10s place position. '03' will be displayed.	<code>03</code>
5	Press the [▲] or [▼] key to change the '0' to '9' of the target code, '93.'	<code>93</code>
6	Press the [ENT] key. Code dr.93 will be displayed.	<code>dr.93</code>
7	Press the [ENT] key once again. The current parameter value for code dr.93 is set to 0 (Do not initialize).	<code>0</code>
8	Press the [▲] key to change the value to 1 (All Grp), and then press the [ENT] key. The parameter value will flash.	<code>1</code>
9	Press the [ENT] key once again. Parameter initialization begins. Parameter initialization is complete when code dr.93 reappears on the display.	<code>dr.93</code>

Note

Following parameter initialization, all parameters are reset to factory default values. Ensure that parameters are reconfigured before running the inverter again after an initialization.

3.3.5 Frequency Setting (Keypad) and Operation (via Terminal Input)

Step	Instruction	Keypad Display
1	Turn on the inverter.	-
2	Ensure that the first code of the Operation group is selected, and code 0.00 (Command Frequency) is displayed, then press the [ENT] key. The first digit on the right will flash.	0.00
3	Press the [◀] key 3 times to go to the 10s place position. The number '0' at the 10s place position will flash.	00.00
4	Press the [▲] key to change it to 1, and then press the [ENT] key. The parameter value (10.00) will flash.	10.00
5	Press the [ENT] key once again to save changes. A change of reference frequency to 10.00 Hz has been completed.	10.00
6	Refer to the wiring diagram at the bottom of the table, and close the switch between the P1 (FX) and CM terminals. The RUN indicator light flashes and the FWD indicator light comes on steady. The current acceleration frequency is displayed.	
7	When the frequency reference is reached (10Hz), open the switch between the P1 (FX) and CM terminals. The RUN indicator light flashes again and the current deceleration frequency is displayed. When the frequency reaches 0Hz, the RUN and FWD indicator lights turn off, and the frequency reference (10.00Hz) is displayed again.	

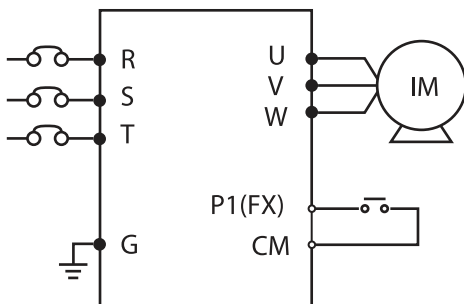

[Wiring Diagram]

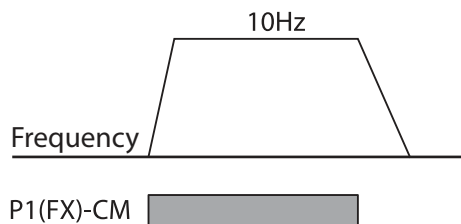

[Operation Pattern]

Note

The instructions in the table are based on the factory default parameter settings. The inverter may not work correctly if the default parameter settings are changed after the inverter is purchased. In such cases, initialize all parameters to reset the values to factory default parameter settings before following the instructions in the table (refer to [5.22 Parameter Initialization](#) on page 170).

3.3.6 Frequency Setting (Potentiometer) and Operation (Terminal Input)

Step	Instruction	Keypad Display
1	Turn on the inverter.	-
2	Ensure that the first code of the Operation group is selected, and the code 0.00 (Command Frequency) is displayed.	
3	Press the [▲] key 4 times to go to the Frq (Frequency reference source) code.	
4	Press the [ENT] key. The Frq code in the Operation group is currently set to 0 (keypad).	
5	Press the [▲] key to change the parameter value to 2 (Potentiometer), and then press the [ENT] key. The new parameter value will flash.	
6	Press the [ENT] key once again. The Frq code will be displayed again. The frequency input has been configured for the potentiometer.	
7	Press the [▼] key 4 times. Returns to the first code of the Operation group (0.00). From here frequency setting values can be monitored.	
8	Adjust the potentiometer to increase or decrease the frequency reference to 10Hz.	-
9	Refer to the wiring diagram at the bottom of the table, and close the switch between the P1 (FX) and CM terminals. The RUN indicator light flashes and the FWD indicator light comes on steady. The current acceleration frequency is displayed.	
10	When the frequency reference is reached (10Hz), open the switch between the P1 (FX) and CM terminals. The RUN indicator light flashes again and the current deceleration frequency is displayed. When the frequency reaches 0Hz, the RUN and FWD indicators turn off, and the frequency reference (10.00Hz) is displayed again.	

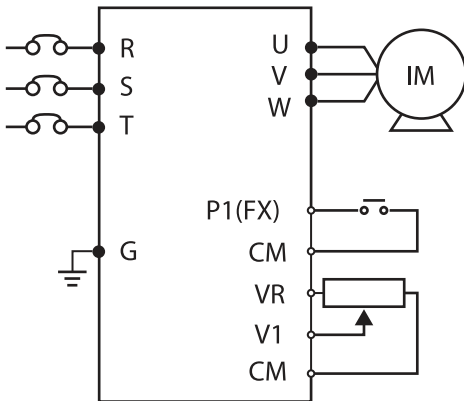

[Wiring Diagram]

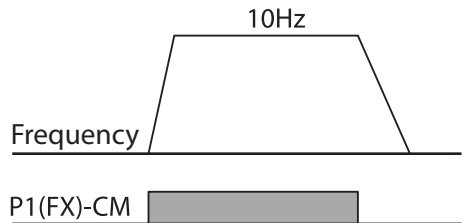

[Operation Pattern]

Note

The instructions in the table are based on the factory default parameter settings. The inverter may not work correctly if the default parameter settings are changed after the inverter is purchased. In such cases, initialize all parameters to reset the factory default parameter settings before following the instructions in the table (refer to [5.22 Parameter Initialization](#) on page 170).

3.3.7 Frequency Setting (Potentiometer) and Operation (Keypad)

Step	Instruction	Keypad Display
1	Turn on the inverter.	-
2	Ensure that the first code of the Operation group is selected, and the code 0.00 (Command Frequency) is displayed.	0.00
3	Press the [▲] key 4 times to go to the drv code.	drv
4	Press the [ENT] key. The drv code in the Operation group is currently set to 1 (Analog Terminal).	1
5	Press the [▼] key to change the parameter value to 0 (Keypad), and then press the [ENT] key. The new parameter value will flash.	0
6	Press the [ENT] key once again. The drv code is displayed again. The frequency input has been configured for the keypad.	drv
7	Press the [▲] key. To move to the Frq (Frequency reference source) code.	Frq

Step	Instruction	Keypad Display
8	Press the [ENT] key. The Frq code in the Operation group is set to 0 (Keypad).	
9	Press the [▲] key to change it to 2 (Potentiometer), and then press the [ENT] key. The new parameter value will flash.	
10	Press the [ENT] key once again. The Frq code is displayed again. The frequency input has been configured for potentiometer.	
11	Press the [▼] key 4 times. Returns to the first code of the Operation group (0.00). From here frequency setting values can be monitored.	
12	Adjust the potentiometer to increase or decrease the frequency reference to 10Hz.	-
13	Press the [RUN] key on the keypad. The RUN indicator light flashes and the FWD indicator light comes on steady. The current acceleration frequency is displayed.	
14	When the frequency reaches the reference (10Hz), press the [STOP/RESET] key on the keypad. The RUN indicator light flashes again and the current deceleration frequency is displayed. When the frequency reaches 0Hz, the RUN and FWD indicator lights turn off, and the frequency reference (10.00Hz) is displayed again.	

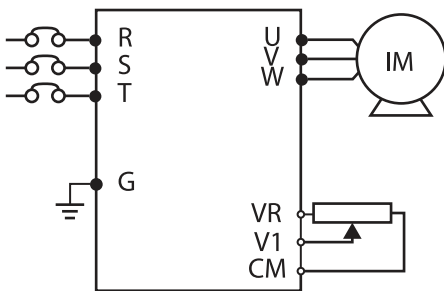

[Wiring Diagram]

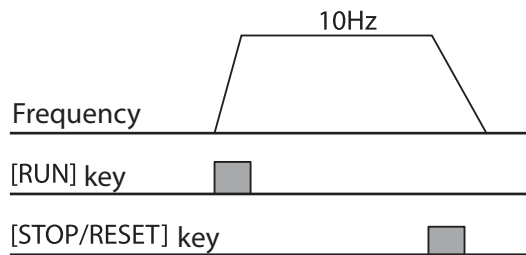

[Operation Pattern]

Note

The instructions in the table are based on the factory default parameter settings. The inverter may not work correctly if the default parameter settings are changed after the inverter is purchased. In such cases, initialize all parameters to reset the factory default parameter settings before following the instructions in the table (refer to [5.22 Parameter Initialization](#) on page 170).

3.4 Monitoring the Operation

3.4.1 Output Current Monitoring

The following example demonstrates how to monitor the output current in the Operation group using the keypad.

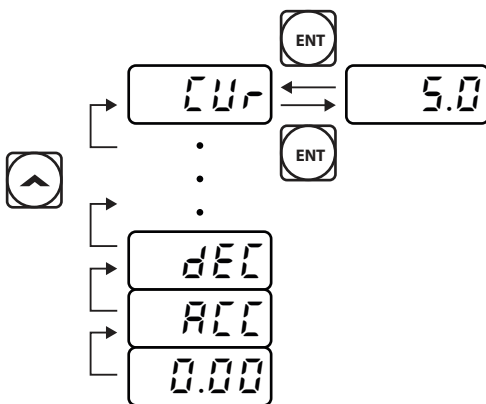

Step	Instruction	Keypad Display
1	Ensure that the first code of the Operation group is selected, and the code 0.00 (Command Frequency) is displayed.	0.00
2	Press the [▲] or [▼] key to move to the Cur code.	Cur
3	Press the [ENT] key. The output current (5.0A) is displayed.	5.0
4	Press the [ENT] key again. Returns to the Cur code.	Cur

Note

You can use the dCL (DC link voltage monitor) and vOL (output voltage monitor) codes in the Operation group in exactly the same way as shown in the example above, to monitor each function's relevant values.

3.4.2 Fault Trip Monitoring

The following example demonstrates how to monitor fault trip conditions in the Operation group using the keypad.

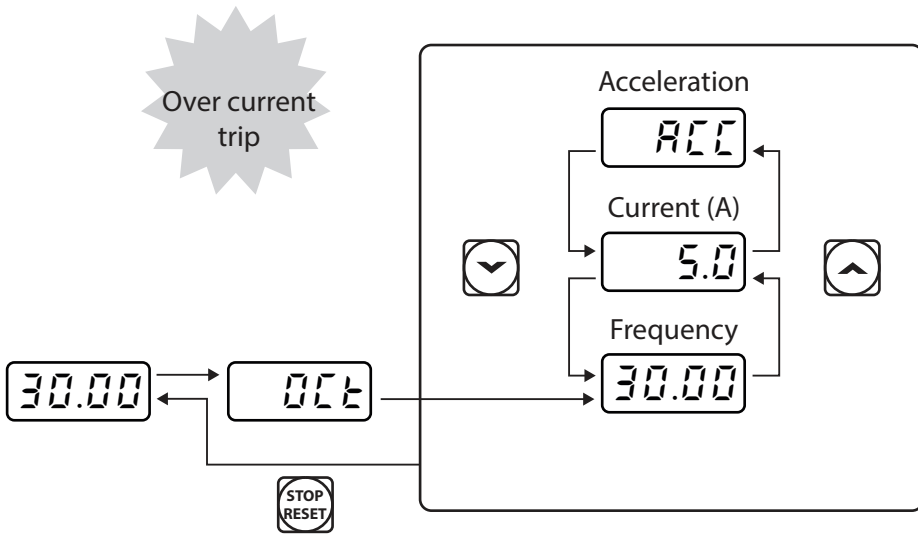

Step	Instruction	Keypad Display
1	Refer to the example keypad display. An over current trip fault has occurred.	
2	Press the [ENT] key, and then the [▲] key. The operation frequency at the time of the fault (30.00Hz) is displayed.	
3	Press the [▲] key. The output current at the time of the fault (5.0A) is displayed.	
4	Press the [▲] key. The operation status at the time of the fault is displayed. ACC on the display indicates that the fault occurred during acceleration.	
5	Press the [STOP/RESET] key. The inverter resets and the fault condition is cleared. The frequency reference is displayed on the keypad.	

Note

- If multiple fault trips occur at the same time, a maximum of 3 fault trip records can be retrieved as shown in the following example.

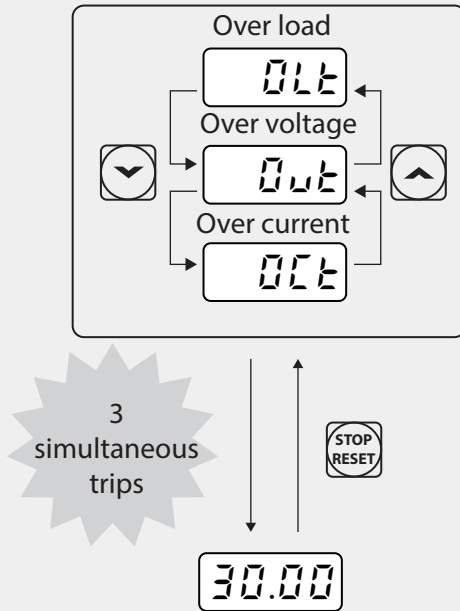

- If a warning condition occurs while running at a specified frequency, the current frequency and the `!Arrn` signal will be displayed alternately, at 1 second intervals. Refer to [6.3 Under load Fault Trip and Warning](#) on page 209 for more details.

4 Learning Basic Features

This chapter describes the basic features of the S100 inverter. Check the reference page in the table to see the detailed description for each of the advanced features.

Basic Tasks	Description	Ref.
Frequency reference source configuration for the keypad	Configures the inverter to allow you to setup or modify frequency reference using the Keypad.	p.66
Frequency reference source configuration for the terminal block (input voltage)	Configures the inverter to allow input voltages at the terminal block (V1, V2) and to setup or modify a frequency reference.	p.67 , p.74
Frequency reference source configuration for the terminal block (input current)	Configures the inverter to allow input currents at the terminal block (I2) and to setup or modify a frequency reference.	p.72
Frequency reference source configuration for the terminal block (input pulse)	Configures the inverter to allow input pulse at the terminal block (T1) and to setup or modify a frequency reference.	p.74
Frequency reference source configuration for RS-485 communication	Configures the inverter to allow communication signals from upper level controllers, such as PLCs or PCs, and to setup or modify a frequency reference.	p.76
Frequency control using analog inputs	Enables the user to hold a frequency using analog inputs at terminals.	p.76
Motor operation display options	Configures the display of motor operation values. Motor operation is displayed either in frequency (Hz) or speed (rpm).	p.77
Multi-step speed (frequency) configuration	Configures multi-step frequency operations by receiving an input at the terminals defined for each step frequency.	p.77
Command source configuration for keypad buttons	Configures the inverter to allow the manual operation of the [FWD], [REV] and [Stop] keys.	p.79
Command source configuration for terminal block inputs	Configures the inverter to accept inputs at the FX/RX terminals.	p.80
Command source configuration for RS-485 communication	Configures the inverter to accept communication signals from upper level controllers, such as PLCs or PCs.	p.81
Local/remote switching via the [ESC] key	Configures the inverter to switch between local and remote operation modes when the [ESC] key is pressed. When the inverter is operated using remote inputs (any input other than one from the keypad), this configuration can be used to perform maintenance on the inverter, without losing or altering saved parameter settings. It can also be used to override remotes and use the keypad immediately in emergencies.	p.82

Basic Tasks	Description	Ref.
Motor rotation control	Configures the inverter to limit a motor's rotation direction.	p.84
Automatic start-up at power-on	Configures the inverter to start operating at power-on. With this configuration, the inverter begins to run and the motor accelerates as soon as power is supplied to the inverter. To use automatic start-up configuration, the operation command terminals at the terminal block must be turned on.	p.84
Automatic restart after reset of a fault trip condition	Configures the inverter to start operating when the inverter is reset following a fault trip. In this configuration, the inverter starts to run and the motor accelerates as soon as the inverter is reset following a fault trip condition. For automatic start-up configuration to work, the operation command terminals at the terminal block must be turned on.	p.85
Acc/Dec time configuration based on the Max. Frequency	Configures the acceleration and deceleration times for a motor based on a defined maximum frequency.	p.86
Acc/Dec time configuration based on the frequency reference	Configures acceleration and deceleration times for a motor based on a defined frequency reference.	p.88
Multi-stage Acc/Dec time configuration using the multi-function terminal	Configures multi-stage acceleration and deceleration times for a motor based on defined parameters for the multi-function terminals.	p.88
Acc/Dec time transition speed (frequency) configuration	Enables modification of acceleration and deceleration gradients without configuring the multi-functional terminals.	p.90
Acc/Dec pattern configuration	Enables modification of the acceleration and deceleration gradient patterns. Basic patterns to choose from include linear and S-curve patterns.	p.91
Acc/Dec stop command	Stops the current acceleration or deceleration and controls motor operation at a constant speed. Multi-function terminals must be configured for this command .	p.94
Linear V/F pattern operation	Configures the inverter to run a motor at a constant torque. To maintain the required torque, the operating frequency may vary during operation.	p.94
Square reduction V/F pattern operation	Configures the inverter to run the motor at a square reduction V/F pattern. Fans and pumps are appropriate loads for square reduction V/F operation.	p.95
User V/F pattern configuration	Enables the user to configure a V/F pattern to match the characteristics of a motor. This configuration is for special-purpose motor applications to achieve optimal performance.	p.96
Manual torque boost	Manual configuration of the inverter to produce a momentary torque boost. This configuration is for loads that require a large amount of starting torque, such as elevators or lifts.	p.97
Automatic torque boost	Automatic configuration of the inverter that provides "auto tuning" that produces a momentary torque boost. This	p.98

Basic Tasks	Description	Ref.
	configuration is for loads that require a large amount of starting torque, such as elevators or lifts.	
Output voltage adjustment	Adjusts the output voltage to the motor when the power supply to the inverter differs from the motor's rated input voltage.	p.98
Accelerating start	Accelerating start is the general way to start motor operation. The typical application configures the motor to accelerate to a target frequency in response to a run command, however there may be other start or acceleration conditions defined.	p.99
Start after DC braking	Configures the inverter to perform DC braking before the motor starts rotating again. This configuration is used when the motor will be rotating before the voltage is supplied from the inverter.	p.100
Deceleration stop	Deceleration stop is the typical method used to stop a motor. The motor decelerates to 0Hz and stops on a stop command, however there may be other stop or deceleration conditions defined.	p.100
Stopping by DC braking	Configures the inverter to apply DC braking during motor deceleration. The frequency at which DC braking occurs must be defined and during deceleration, when the motor reaches the defined frequency, DC braking is applied.	p.101
Free-run stop	Configures the inverter to stop output to the motor using a stop command. The motor will free-run until it slows down and stops.	p.102
Power braking	Configures the inverter to provide optimal, motor deceleration, without tripping over-voltage protection.	p.103
Start/maximum frequency configuration	Configures the frequency reference limits by defining a start frequency and a maximum frequency.	p.104
Upper/lower frequency limit configuration	Configures the frequency reference limits by defining an upper limit and a lower limit.	p.104
Frequency jump	Configures the inverter to avoid running a motor in mechanically resonating frequencies.	p.105
2 nd Operation Configuration	Used to configure the 2 nd operation mode and switch between the operation modes according to your requirements.	p.106
Multi-function input terminal control configuration	Enables the user to improve the responsiveness of the multi-function input terminals.	p.107
P2P communication configuration	Configures the inverter to share input and output devices with other inverters.	p.108
Multi-keypad configuration	Enables the user to monitor multiple inverters with one monitoring device.	p.109
User sequence configuration	Enables the user to implement simple sequences using various function blocks.	p.111

4.1 Setting Frequency Reference

The S100 inverter provides several methods to setup and modify a frequency reference for an operation. The keypad, analog inputs [for example voltage (V1, V2) and current (I2) signals], or RS-485 (digital signals from higher-level controllers, such as PC or PLC) can be used.

Group	Code	Name	LCD Display	Parameter Setting		Setting Range	Unit
Operation	Frq	Frequency reference source	Ref Freq Src	0	KeyPad-1	0-12	-
				1	KeyPad-2		
				2	V1		
				4	V2		
				5	I2		
				6	Int 485		
				8	Field Bus		
				12	Pulse		

4.1.1 Keypad as the Source (KeyPad-1 setting)

You can modify frequency reference by using the keypad and apply changes by pressing the [ENT] key. To use the keypad as a frequency reference input source, go to the Frq (Frequency reference source) code in the Operation group and change the parameter value to 0 (Keypad-1). Input the frequency reference for an operation at the 0.00(Command Frequency) code in the Operation group.)

Group	Code	Name	LCD Display	Parameter Setting		Setting Range	Unit
Operation	Frq	Frequency reference source	Freq Ref Src	0	KeyPad-1	0-12	
	0.00	Frequency reference		0.00		Min to Max Frq*	Hz

* You cannot set a frequency reference that exceeds the Max. Frequency, as configured with dr.20.

4.1.2 Keypad as the Source (KeyPad-2 setting)

You can use the [▲] and [▼] keys to modify a frequency reference. To use this as a second option, set the keypad as the source of the frequency reference, by going to the Frq (Frequency reference source) code in the Operation group and change the parameter value to 1 (Keypad-2). This allows frequency reference values to be increased or decreased by pressing the [▲] and [▼] keys.

Group	Code	Name	LCD Display	Parameter Setting		Setting Range	Unit
Operation	Frq	Frequency reference source	Freq Ref Src	1	KeyPad-2	0-12	-
	0.00	Frequency reference		0.00		Min to Max Frq*	Hz

* You cannot set a frequency reference that exceeds the Max. Frequency, as configured with dr.20.

4.1.3 V1 Terminal as the Source

You can set and modify a frequency reference by setting voltage inputs when using the V1 terminal. Use voltage inputs ranging from 0 to 10V (unipolar) for forward only operation. Use voltage inputs ranging from -10 to +10V (bipolar) for both directions, where negative voltage inputs are used reverse operations.

4.1.3.1 Setting a Frequency Reference for 0-10V Input

Set code 06 (V1 Polarity) to 0 (unipolar) in the Input Terminal group (IN). Use a voltage output from an external source or use the voltage output from the VR terminal to provide inputs to V1. Refer to the diagrams below for the wiring required for each application.



[External source application] [Internal source (VR) application]

Group	Code	Name	LCD Display	Parameter Setting		Setting Range	Unit
Operation	Frq	Frequency reference source	Freq Ref Src	2	V1	0-12	-
In	01	Frequency at maximum analog input	Freq at 100%	Maximum frequency		0.00- Max. Frequency	Hz
	05	V1 input monitor	V1 Monitor [V]	0.00		0.00-12.00	V
	06	V1 polarity options	V1 Polarity	0	Unipolar	0-1	-
	07	V1 input filter time	V1 Filter	10		0-10000	ms

Group	Code	Name	LCD Display	Parameter Setting	Setting Range	Unit
		constant				
	08	V1 minimum input voltage	V1 volt x1	0.00	0.00–10.00	V
	09	V1 output at minimum voltage (%)	V1 Perc y1	0.00	0.00–100.00	%
	10	V1 maximum input voltage	V1 Volt x2	10.00	0.00– 12.00	V
	11	V1 output at maximum voltage (%)	V1 Perc y2	100.00	0–100	%
	16	Rotation direction options	V1 Inverting	0 No	0–1	-
	17	V1 Quantizing level	V1 Quantizing	0.04	0.00*, 0.04–10.00	%

* Quantizing is disabled if '0' is selected.

0–10V Input Voltage Setting Details

Code	Description
In.01 Freq at 100%	<p>Configures the frequency reference at the maximum input voltage when a potentiometer is connected to the control terminal block. A frequency set with code In.01 becomes the maximum frequency only if the value set in code In.11 (or In.15) is 100(%)</p> <ul style="list-style-type: none"> Set code In.01 to 40.00 and use default values for codes In.02–In.16. Motor will run at 40.00Hz when a 10V input is provided at V1. Set code In.11 to 50.00 and use default values for codes In.01–In.16. Motor will run at 30.00Hz (50% of the default maximum frequency–60Hz) when a 10V input is provided at V1.
In.05 V1 Monitor[V]	Configures the inverter to monitor the input voltage at V1.
In.07 V1 Filter	<p>V1 Filter may be used when there are large variations between reference frequencies. Variations can be mitigated by increasing the time constant, but this will require an increased response time.</p> <p>The value t (time) indicates the time required for the frequency to reach 63% of the reference, when external input voltages are provided in multiple steps.</p>

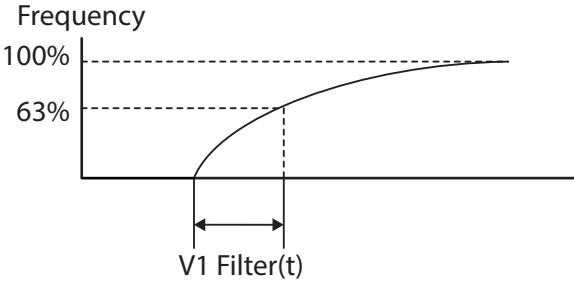
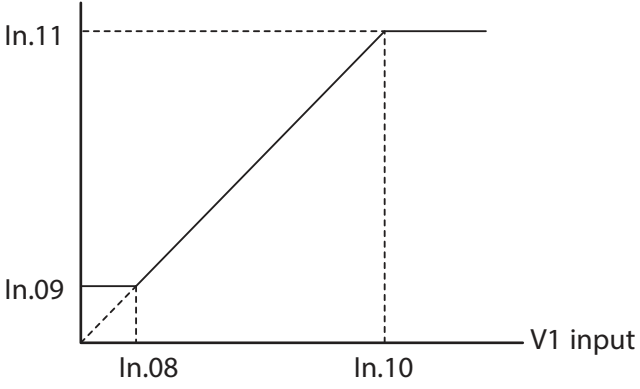
Code	Description
	<p>V1 input from external source </p>  <p>[V1 Filter]</p>
<p>In.08 V1 Volt x1– In.11 V1 Perc y2</p>	<p>These parameters are used to configure the gradient level and offset values of the Output Frequency, based on the Input Voltage.</p> <p>Frequency reference</p>  <p>[Volt x1–In.11 V1 Perc y2]</p>
<p>In.16 V1 Inverting</p>	<p>Inverts the direction of rotation. Set this code to 1 (Yes) if you need the motor to run in the opposite direction from the current rotation.</p>
<p>In.17.V1 Quantizing</p>	<p>Quantizing may be used when the noise level is high in the analog input (V1 terminal) signal. Quantizing is useful when you are operating a noise-sensitive system, because it suppresses any signal noise. However, quantizing will diminish system sensitivity (resultant power of the output frequency will decrease based on the analog input). You can also turn on the low-pass filter using code In.07 to reduce the noise, but increasing the value will reduce responsiveness and may cause pulsations (ripples) in the output frequency.</p>

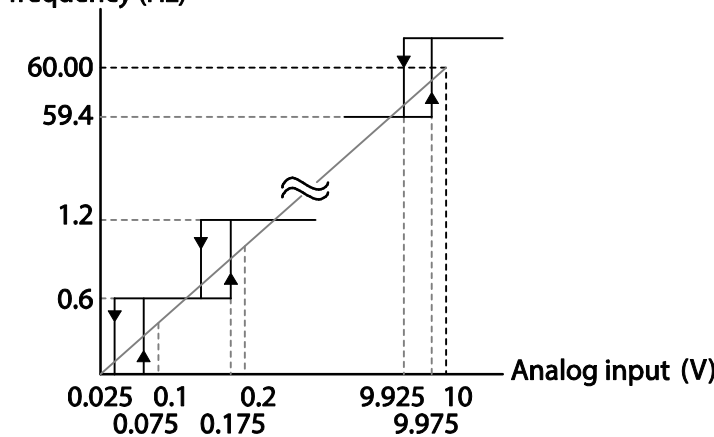
Code	Description
	<p>Parameter values for quantizing refer to a percentage based on the maximum input. Therefore, if the value is set to 1% of the analog maximum input (60Hz), the output frequency will increase or decrease by 0.6Hz per 0.1V difference.</p> <p>When the analog input is increased, an increase to the input equal to 75% of the set value will change the output frequency, and then the frequency will increase according to the set value. Likewise, when the analog input decreases, a decrease in the input equal to 75% of the set value will make an initial change to the output frequency.</p> <p>As a result, the output frequency will be different at acceleration and deceleration, mitigating the effect of analog input changes over the output frequency.</p> <p>Output frequency (Hz)</p>  <p>[V1 Quantizing]</p>

4.1.3.2 Setting a Frequency Reference for -10–10V Input

Set the Frq (Frequency reference source) code in the Operation group to 2 (V1), and then set code 06 (V1 Polarity) to 1 (bipolar) in the Input Terminal group (IN). Use the output voltage from an external source to provide input to V1.

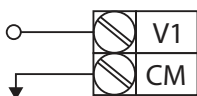

[V1 terminal wiring]

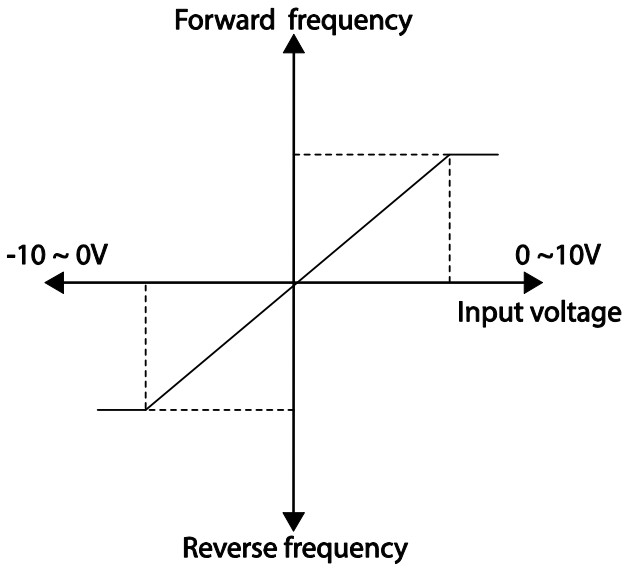

[Bipolar input voltage and output frequency]

Group	Code	Name	LCD Display	Parameter Setting	Setting Range	Unit
Operation	Frq	Frequency reference source	Freq Ref Src	2 V1	0-12	-
In	01	Frequency at maximum analog input	Freq at 100%	60.00	0- Max Frequency	Hz
	05	V1 input monitor	V1 Monitor	0.00	0.00-12.00V	V
	06	V1 polarity options	V1 Polarity	1 Bipolar	0-1	-
	12	V1 minimum input voltage	V1- volt x1	0.00	10.00-0.00V	V
	13	V1 output at minimum voltage (%)	V1- Perc y1	0.00	-100.00-0.00%	%
	14	V1 maximum input voltage	V1- Volt x2	-10.00	-12.00-0.00V	V
	15	V1 output at maximum voltage (%)	V1- Perc y2	-100.00	-100.00-0.00%	%

Rotational Directions for Different Voltage Inputs

Command / Voltage Input	Input voltage	
	0-10V	-10-0V
FWD	Forward	Reverse
REV	Reverse	Forward

-10–10V Voltage Input Setting Details

Code	Description
In.12 V1- volt x1– In.15 V1- Perc y2	<p>Sets the gradient level and off-set value of the output frequency in relation to the input voltage. These codes are displayed only when In.06 is set to 1 (bipolar). As an example, if the minimum input voltage (at V1) is set to -2 (V) with 10% output ratio, and the maximum voltage is set to -8 (V) with 80% output ratio respectively, the output frequency will vary within the range of 6 - 48 Hz.</p> <p>[In.12 V1-volt X1–In.15 V1 Perc y]</p> <p>For details about the 0–+10V analog inputs, refer to the code descriptions In.08 V1 volt x1–In.11 V1 Perc y2 on page 69.</p>

4.1.3.3 Setting a Reference Frequency using Input Current (I2)

You can set and modify a frequency reference using input current at the I2 terminal after selecting current input at SW 2. Set the Frq (Frequency reference source) code in the Operation group to 5 (I2) and apply 4–20mA input current to I2.

Group	Code	Name	LCD Display	Parameter Setting	Setting Range	Unit
Operation	Frq	Frequency reference source	Freq Ref Src	5 I2	0-12	-
In	01	Frequency at maximum analog input	Freq at 100%	60.00	0- Maximum Frequency	Hz
	50	I2 input monitor	I2 Monitor	0.00	0.00–24.00	mA
	52	I2 input filter time constant	I2 Filter	10	0-10000	ms
	53	I2 minimum input current	I2 Curr x1	4.00	0.00–20.00	mA

Group	Code	Name	LCD Display	Parameter Setting	Setting Range	Unit	
	54	I2 output at minimum current (%)	I2 Perc y1	0.00	0-100	%	
	55	I2 maximum input current	I2 Curr x2	20.00	0.00-24.00	mA	
	56	I2 output at maximum current (%)	I2 Perc y2	100.00	0.00-100.00	%	
	61	I2 rotation direction options	I2 Inverting	0	No	0-1	-
	62	I2 Quantizing level	I2 Quantizing	0.04	0*, 0.04-10.00	%	

* Quantizing is disabled if '0' is selected.

Input Current (I2) Setting Details

Code	Description
In.01 Freq at 100%	<p>Configures the frequency reference for operation at the maximum current (when In.56 is set to 100%).</p> <ul style="list-style-type: none"> If In.01 is set to 40.00Hz, and default settings are used for In.53-56, 20mA input current (max) to I2 will produce a frequency reference of 40.00Hz. If In.56 is set to 50.00 (%), and default settings are used for In.01 (60Hz) and In.53-55, 20mA input current (max) to I2 will produce a frequency reference of 30.00Hz (50% of 60Hz).
In.50 I2 Monitor	Used to monitor input current at I2.
In.52 I2 Filter	Configures the time for the operation frequency to reach 63% of target frequency based on the input current at I2.
In.53 I2 Curr x1- In.56 I2 Perc y2	<p>Configures the gradient level and off-set value of the output frequency.</p> <p>Frequency Reference</p> <p>[Gradient and off-set configuration based on output frequency]</p>

4.1.4 Setting a Frequency Reference with Input Voltage (Terminal I2)

Set and modify a frequency reference using input voltage at I2 (V2) terminal by setting SW2 to V2. Set the Frq (Frequency reference source) code in the Operation group to 4 (V2) and apply 0-12V input voltage to I2 (=V2, Analog current/voltage input terminal). Codes In.35-47 will not be displayed when I2 is set to receive current input (Frq code parameter is set to 5).

Group	Code	Name	LCD Display	Parameter Setting		Setting Range	Unit
Operation	Frq	Frequency reference source	Freq Ref Src	4	V2	0-12	-
In	35	V2 input display	V2 Monitor	0.00		0.00-12.00	V
	37	V2 input filter time constant	V2 Filter	10		0-10000	ms
	38	Minimum V2 input voltage	V2 Volt x1	0.00		0.00-10.00	V
	39	Output% at minimum V2 voltage	V2 Perc y1	0.00		0.00-100.00	%
	40	Maximum V2 input voltage	V2 Volt x2	10.00		0.00-10.00	V
	41	Output% at maximum V2 voltage	V2 Perc y2	100.00		0.00-100.00	%
	46	Invert V2 rotational direction	V2 Inverting	0	No	0-1	-
	47	V2 quantizing level	V2 Quantizing	0.04		0.00*, 0.04-10.00	%

* Quantizing is disabled if '0' is selected.

4.1.5 Setting a Frequency with TI Pulse Input

Set a frequency reference by setting the Frq (Frequency reference source) code in Operation group to 12 (Pulse). In case of Standard I/O, set the In.69 P5 Define to 54(TI) and providing 0-32.00kHz pulse frequency to P5.

Group	Code	Name	LCD Display	Parameter Setting		Setting Range	Unit
Operation	Frq	Frequency reference source	Freq Ref Src	12	Pulse	0-12	-
In	69	P5 terminal function setting	P5 Define	54	TI	0-54	-
	01	Frequency at maximum analog input	Freq at 100%	60.00		0.00- Maximum frequency	Hz

Group	Code	Name	LCD Display	Parameter Setting	Setting Range	Unit
	91	Pulse input display	Pulse Monitor	0.00	0.00–50.00	kHz
	92	TI input filter time constant	TI Filter	10	0–9999	ms
	93	TI input minimum pulse	TI Pls x1	0.00	0.00–32.00	kHz
	94	Output% at TI minimum pulse	TI Perc y1	0.00	0.00–100.00	%
	95	TI Input maximum pulse	TI Pls x2	32.00	0.00–32.00	kHz
	96	Output% at TI maximum pulse	TI Perc y2	100.00	0.00–100.00	%
	97	Invert TI direction of rotation	TI Inverting	0 No	0–1	-
	98	TI quantizing level	TI Quantizing	0.04	0.00*, 0.04–10.00	%

* Data shaded in grey is applied only for Standard I/O.

*Quantizing is disabled if '0' is selected.

TI Pulse Input Setting Details

Code	Description
In.69 P5 Define	In case of Standard I/O, Pulse input TI and Multi-function terminal P5 share the same terminal. Set the In.69 P5 Define to 54(TI).
In.01 Freq at 100%	Configures the frequency reference at the maximum pulse input. The frequency reference is based on 100% of the value set with In.96. <ul style="list-style-type: none"> If In.01 is set to 40.00 and codes In.93–96 are set at default, 32kHz input to TI yields a frequency reference of 40.00Hz. If In.96 is set to 50.00 and codes In.01, In.93–95 are set at default, 32kHz input to the TI terminal yields a frequency reference of 30.00Hz.
In.91 Pulse Monitor	Displays the pulse frequency supplied at TI.
In.92 TI Filter	Sets the time for the pulse input at TI to reach 63% of its nominal frequency (when the pulse frequency is supplied in multiple steps).
In.93 TI Pls x1– In.96 TI Perc y2	Configures the gradient level and offset values for the output frequency.

Code	Description
	Frequency reference
In.97 TI Inverting– In.98 TI Quantizing	Identical to In.16-17 (refer to In.16 V1 Inverting/In.17.V1 Quantizing on page 69).

4.1.6 Setting a Frequency Reference via RS-485 Communication

Control the inverter with upper-level controllers, such as PCs or PLCs, via RS-485 communication. Set the Frq (Frequency reference source) code in the Operation group to 6 (Int 485) and use the RS-485 signal input terminals (S+/S-/SG) for communication. Refer to 7 *RS-485 Communication Features* on page 219.

Group	Code	Name	LCD Display	Parameter Setting		Setting Range	Unit
Operation	Frq	Frequency reference source	Freq Ref Src	6	Int 485	0-12	-
In	01	Integrated RS-485 communication inverter ID	Int485 St ID	-	1	1-250	-
	02	Integrated communication protocol	Int485 Proto	0	ModBus RTU	0-2	-
				1	Reserved		
				2	LS Inv 485		
	03	Integrated communication speed	Int485 BaudR	3	9600 bps	0-7	-
	04	Integrated communication frame configuration	Int485 Mode	0	D8/PN/S1	0-3	-
				1	D8/PN/S2		
				2	D8/PE/S1		
3				D8/PO/S1			

4.2 Frequency Hold by Analog Input

If you set a frequency reference via analog input at the control terminal block, you can hold the operation frequency of the inverter by assigning a multi-function input as the analog frequency

hold terminal. The operation frequency will be fixed upon an analog input signal.

group	Code	Name	LCD Display	Parameter Setting	Setting Range	Unit	
Operation	Frq	Frequency reference source	Freq Ref Src	0	Keypad-1	0-12	-
				1	Keypad-2		
				2	V1		
				4	V2		
				5	I2		
				6	Int 485		
				8	Field Bus		
			12	Pulse			
In	65-71	Px terminal configuration	Px Define(Px: P1-P7)	21	Analog Hold	0-54	-

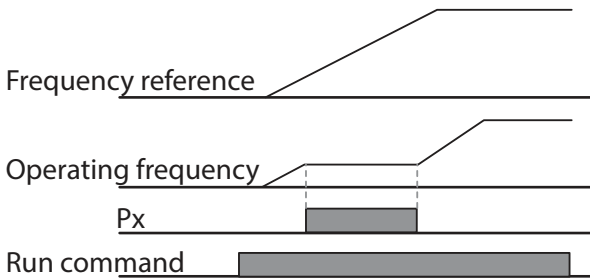

4.3 Changing the Displayed Units (Hz↔Rpm)

You can change the units used to display the operational speed of the inverter by setting Dr. 21 (Speed unit selection) to 0 (Hz) or 1 (Rpm). This function is available only with the LCD keypad.

Group	Code	Name	LCD Display	Parameter Setting	Setting Range	Unit	
dr	21	Speed unit selection	Hz/Rpm Sel	0	Hz Display	0-1	-
				1	Rpm Display		

4.4 Setting Multi-step Frequency

Multi-step operations can be carried out by assigning different speeds (or frequencies) to the Px terminals. Step 0 uses the frequency reference source set with the Frq code in the Operation group. Px terminal parameter values 7 (Speed-L), 8 (Speed-M) and 9 (Speed-H) are recognized as binary commands and work in combination with Fx or Rx run commands. The inverter operates according to the frequencies set with St.1-3 (multi-step frequency 1-3), bA.53-56 (multi-step

frequency 4-7) and the binary command combinations.

Group	Code	Name	LCD Display	Parameter Setting		Setting Range	Unit
Operation	St1-St3	Multi-step frequency 1-3	Step Freq - 1-3	-		0-Maximum frequency	Hz
bA	53-56	Multi-step frequency 4-7	Step Freq - 4-7	-		0-Maximum frequency	Hz
In	65-71	Px terminal configuration	Px Define (Px: P1-P7)	7	Speed-L	0-54	-
				8	Speed-M		-
9				Speed-H	-		
	89	Multi-step command delay time	InCheckTime	1		1-5000	ms

Multi-step Frequency Setting Details

Code	Description
Operation group St 1-St3 Step Freq - 1-3	Configure multi-step frequency 1-3. If an LCD keypad is in use, bA.50-52 is used instead of St1-St3 (multi-step frequency 1-3).
bA.53-56 Step Freq - 4-7	Configure multi-step frequency 4-7.
In.65-71 Px Define	<p>Choose the terminals to setup as multi-step inputs, and then set the relevant codes (In.65-71) to 7(Speed-L), 8(Speed-M), or 9(Speed-H).</p> <p>Provided that terminals P3, P4 and P5 have been set to Speed-L, Speed-M and Speed-H respectively, the following multi-step operation will be available.</p>

Code	Description				
	[An example of a multi-step operation]				
	Speed	Fx/Rx	P5	P4	P3
	0	✓	-	-	-
	1	✓	-	-	✓
	2	✓	-	✓	-
	3	✓	-	✓	✓
	4	✓	✓	-	-
	5	✓	✓	-	✓
	6	✓	✓	✓	-
	7	✓	✓	✓	✓
In.89 InCheck Time	<p>Set a time interval for the inverter to check for additional terminal block inputs after receiving an input signal.</p> <p>After adjusting In.89 to 100ms and an input signal is received at P5, the inverter will search for inputs at other terminals for 100ms, before proceeding to accelerate or decelerate based on P5's configuration.</p>				

4.5 Command Source Configuration

Various devices can be selected as command input devices for the S100 inverter. Input devices available to select include keypad, multi-function input terminal, RS-485 communication and field bus adapter.

Group	Code	Name	LCD Display	Parameter Setting	Setting Range	Unit	
Operation	drv	Command Source	Cmd Source*	0	Keypad	0-4	-
				1	Fx/Rx-1		
				2	Fx/Rx-2		
				3	Int 485		
				4	Field Bus		

* Displayed under DRV-06 on the LCD keypad.

4.5.1 The Keypad as a Command Input Device

The keypad can be selected as a command input device to send command signals to the inverter. This is configured by setting the drv (command source) code to 0 (Keypad). Press the [RUN] key on the keypad to start an operation, and the [STOP/RESET] key to end it.

group	Code	Name	LCD Display	Parameter Setting		Setting Range	Unit
Operation	drv	Command source	Cmd Source*	0	KeyPad	0-4	-

* Displayed under DRV-06 on the LCD keypad.

4.5.2 Terminal Block as a Command Input Device (Fwd/Rev Run Commands)

Multi-function terminals can be selected as a command input device. This is configured by setting the drv (command source) code in the Operation group to 1(Fx/Rx). Select 2 terminals for the forward and reverse operations, and then set the relevant codes (2 of the 5 multi-function terminal codes, In.65-71 for P1-P7) to 1(Fx) and 2(Rx) respectively. This application enables both terminals to be turned on or off at the same time, constituting a stop command that will cause the inverter to stop operation.

Group	Code	Name	LCD Display	Parameter Setting		Setting Range	Unit
Operation	drv	Command source	Cmd Source*	1	Fx/Rx-1	0-4	-
In	65-71	Px terminal configuration	Px Define(Px: P1-P7)	1	Fx	0-54	-
				2	Rx		

* Displayed under DRV-06 on the LCD keypad.

Fwd/Rev Command by Multi-function Terminal – Setting Details

Code	Description
Operation group drv- Cmd Source	Set to 1(Fx/Rx-1).
In.65-71 Px Define	Assign a terminal for forward (Fx) operation. Assign a terminal for reverse (Rx) operation.

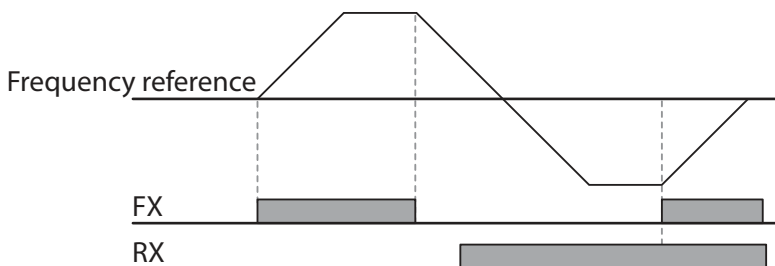

4.5.3 Terminal Block as a Command Input Device (Run and Rotation Direction Commands)

Multi-function terminals can be selected as a command input device. This is configured by setting the drv (command source) code in the Operation group to 2(Fx/Rx-2). Select 2 terminals for run and rotation direction commands, and then select the relevant codes (2 of the 5 multi-function terminal codes, In.65-71 for P1-P7) to 1(Fx) and 2(Rx) respectively. This application uses an Fx input as a run command, and an Rx input to change a motor's rotation direction (On-Rx, Off-Fx).

Group	Code	Name	LCD Display	Parameter Setting		Setting Range	Unit
Operation	Drv	Command source	Cmd Source*	2	Fx/Rx-2	0-4	-
In	65-71	Px terminal configuration	Px Define (Px: P1 - P7)	1	Fx	0-54	-
				2	Rx		

* Displayed under DRV-06 on the LCD keypad.

Run Command and Fwd/Rev Change Command Using Multi-function Terminal – Setting Details

Code	Description
Operation group drv Cmd Source	Set to 2(Fx/Rx-2).
In.65-71 Px Define	Assign a terminal for run command (Fx). Assign a terminal for changing rotation direction (Rx).

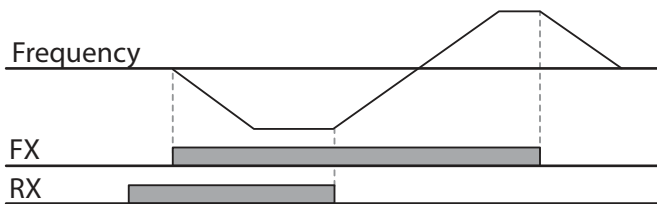

4.5.4 RS-485 Communication as a Command Input Device

Internal RS-485 communication can be selected as a command input device by setting the drv (command source) code in the Operation group to 3(Int 485). This configuration uses upper level controllers such as PCs or PLCs to control the inverter by transmitting and receiving signals via the S+, S-, and Sg terminals at the terminal block. For more details, refer to [7 RS-485 Communication Features](#) on page 219.

Group	Code	Name	LCD Display	Parameter Setting		Setting Range	Unit
Operation	drv	Command source	Cmd Source*	3	Int 485	0-4	-

Group	Code	Name	LCD Display	Parameter Setting		Setting Range	Unit
CM	01	Integrated communication inverter ID	Int485 St ID	1		1-250	-
	02	Integrated communication protocol	Int485 Proto	0	ModBus RTU	0-2	-
	03	Integrated communication speed	Int485 BaudR	3	9600 bps	0-7	-
	04	Integrated communication frame setup	Int485 Mode	0	D8 / PN / S1	0-3	-

* Displayed under DRV-06 on the LCD keypad.

4.6 Local/Remote Mode Switching

Local/remote switching is useful for checking the operation of an inverter or to perform an inspection while retaining all parameter values. Also, in an emergency, it can also be used to override control and operate the system manually using the keypad.

The [ESC] key is a programmable key that can be configured to carry out multiple functions. For more details, refer to [3.2.4 Configuring the \[ESC\] Key](#) on page 50.

Group	Code	Name	LCD Display	Parameter Setting		Setting Range	Unit
dr	90	[ESC] key functions	-	2	Local/Remote	0-2	-
Operation	drv	Command source	Cmd Source*	1	Fx/Rx-1	0-4	-

* Displayed under DRV-06 on the LCD keypad.

Local/Remote Mode Switching Setting Details

Code	Description
dr.90 [ESC] key functions	Set dr.90 to 2(Local/Remote) to perform local/remote switching using the [ESC] key. Once the value is set, the inverter will automatically begin operating in remote mode. Changing from local to remote will not alter any previously configured parameter values and the operation of the inverter will not change. Press the [ESC] key to switch the operation mode back to "local."The SET light will flash, and the inverter will operate using the [RUN] key on the keypad. Press the [ESC] key again to switch the operation mode back to "remote."The SET light will turn off and the inverter will operate according to the previous drv code configuration.

Note**Local/Remote Operation**

- Full control of the inverter is available with the keypad during local operation (local operation).
- During local operation, jog commands will only work if one of the P1–P7 multi-function terminals (codes In.65–71) is set to 13(RUN Enable) and the relevant terminal is turned on.
- During remote operation (remote operation), the inverter will operate according to the previously set frequency reference source and the command received from the input device.
- If Ad.10 (power-on run) is set to 0(No), the inverter will NOT operate on power-on even when the following terminals are turned on:
 - Fwd/Rev run (Fx/Rx) terminal
 - Fwd/Rev jog terminal (Fwd jog/Rev Jog)
 - Pre-Excitation terminal

To operate the inverter manually with the keypad, switch to local mode. Use caution when switching back to remote operation mode as the inverter will stop operating. If Ad.10 (power-on run) is set to 0(No), a command through the input terminals will work ONLY AFTER all the terminals listed above have been turned off and then turned on again.

- If the inverter has been reset to clear a fault trip during an operation, the inverter will switch to local operation mode at power-on, and full control of the inverter will be with the keypad. The inverter will stop operating when operation mode is switched from “local” to “remote”. In this case, a run command through an input terminal will work ONLY AFTER all the input terminals have been turned off.

Inverter Operation During Local/Remote Switching

Switching operation mode from “remote” to “local” while the inverter is running will cause the inverter to stop operating. Switching operation mode from “local” to “remote” however, will cause the inverter to operate based on the command source:

- Analog commands via terminal input: the inverter will continue to run without interruption based on the command at the terminal block. If a reverse operation (Rx) signal is ON at the terminal block at startup, the inverter will operate in the reverse direction even if it was running in the forward direction in local operation mode before the reset.
- Digital source commands: all command sources except terminal block command sources (which are analog sources) are digital command sources that include the keypad, LCD keypad, and communication sources. The inverter stops operation when switching to remote operation mode, and then starts operation when the next command is given.

⚠ Caution

Use local/remote operation mode switching only when it is necessary. Improper mode switching may result in interruption of the inverter’s operation.

4.7 Forward or Reverse Run Prevention

The rotation direction of motors can be configured to prevent motors to only run in one direction. Pressing the [REV] key on the LCD keypad when direction prevention is configured, will cause the motor to decelerate to 0Hz and stop. The inverter will remain on.

Group	Code	Name	LCD Display	Parameter Setting		Setting Range	Unit
Ad	09	Run prevention options	Run Prevent	0	None	0-2	-
				1	Forward Prev		
				2	Reverse Prev		

Forward/Reverse Run Prevention Setting Details

Code	Description		
Ad.09 Run Prevent	Choose a direction to prevent.		
	Setting		Description
	0	None	Do not set run prevention.
	1	Forward Prev	Set forward run prevention.
	2	Reverse Prev	Set reverse run prevention.

4.8 Power-on Run

A power-on command can be setup to start an inverter operation after powering up, based on terminal block operation commands (if they have been configured). To enable power-on run set the drv (command source) code to 1 (Fx/Rx-1) or 2 (Fx/Rx-2) in the Operation group.

Group	Code	Name	LCD Display	Parameter Setting		Setting Range	Unit
Operation	drv	Command source	Cmd Source*	1, 2	Fx/Rx-1 or Fx/Rx-2	0-4	-
Ad	10	Power-on run	Power-on Run	1	Yes	0-1	-

* Displayed under DRV-06 on the LCD keypad.

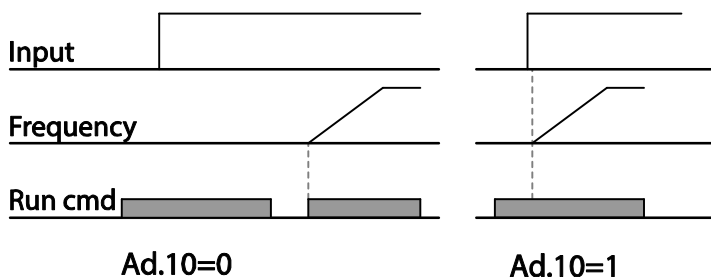

Note

- A fault trip may be triggered if the inverter starts operation while a motor's load (fan-type load) is in free-run state. To prevent this from happening, set bit4 to 1 in Cn. 71 (speed search options) of the Control group. The inverter will perform a speed search at the beginning of the operation.
- If the speed search is not enabled, the inverter will begin its operation in a normal V/F pattern and accelerate the motor. If the inverter has been turned on without power-on run enabled, the terminal block command must first be turned off, and then turned on again to begin the inverter's operation.

Caution

Use caution when operating the inverter with Power-on Run enabled as the motor will begin rotating when the inverter starts up.

4.9 Reset and Restart

Reset and restart operations can be setup for inverter operation following a fault trip, based on the terminal block operation command (if it is configured). When a fault trip occurs, the inverter cuts off the output and the motor will free-run. Another fault trip may be triggered if the inverter begins its operation while motor load is in a free-run state.

Group	Code	Name	LCD Display	Parameter Setting	Setting Range	Unit
Operation	drv	Command source	Cmd Source*	1	Fx/Rx-1 or	0-4
				2	Fx/Rx-2	
Pr	08	Reset restart setup	RST Restart	1	Yes	0-1
	09	No. of auto restart	Retry Number	0		0-10
	10	Auto restart delay time	Retry Delay	1.0		0-60

* Displayed under DRV-06 in an LCD keypad.

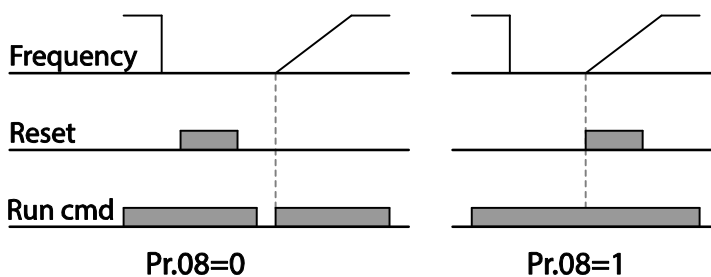

Note

- To prevent a repeat fault trip from occurring, set Cn.71 (speed search options) bit 2 equal to 1. The inverter will perform a speed search at the beginning of the operation.
- If the speed search is not enabled, the inverter will start its operation in a normal V/F pattern and accelerate the motor. If the inverter has been turned on without 'reset and restart' enabled, the terminal block command must be first turned off, and then turned on again to begin the inverter's operation.

⚠ Caution

Use caution when operating the inverter with Power-on Run enabled as the motor will begin rotating when the inverter starts up.

4.10 Setting Acceleration and Deceleration Times

4.10.1 Acc/Dec Time Based on Maximum Frequency

Acc/Dec time values can be set based on maximum frequency, not on inverter operation frequency. To set Acc/Dec time values based on maximum frequency, set bA. 08 (Acc/Dec reference) in the Basic group to 0 (Max Freq).

Acceleration time set at the ACC (Acceleration time) code in the Operation group (dr.03 in an LCD keypad) refers to the time required for the inverter to reach the maximum frequency from a stopped (0Hz) state. Likewise, the value set at the dEC (deceleration time) code in the Operation group (dr.04 in an LCD keypad) refers to the time required to return to a stopped state (0Hz) from the maximum frequency.

Group	Code	Name	LCD Display	Parameter Setting		Setting Range	Unit
Operation	ACC	Acceleration time	Acc Time	20.0		0.0–600.0	sec
	dEC	Deceleration time	Dec Time	30.0		0.0–600.0	sec
	20	Maximum frequency	Max Freq	60.00		40.00–400.00	Hz
bA	08	Acc/Dec reference frequency	Ramp T Mode	0	Max Freq	0–1	-
	09	Time scale	Time scale	1	0.1sec	0–2	-

Acc/Dec Time Based on Maximum Frequency – Setting Details

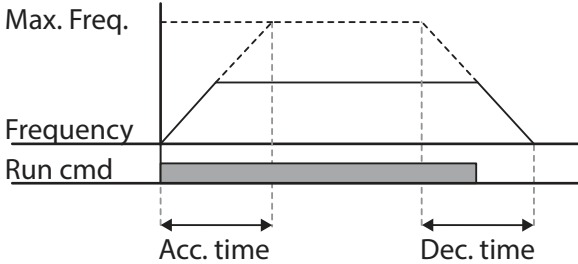
Code	Description												
<p>bA.08 Ramp T Mode</p>	<p>Set the parameter value to 0 (Max Freq) to setup Acc/Dec time based on maximum frequency.</p> <table border="1" data-bbox="364 428 1236 602"> <thead> <tr> <th colspan="2">Configuration</th> <th>Description</th> </tr> </thead> <tbody> <tr> <td>0</td> <td>Max Freq</td> <td>Set the Acc/Dec time based on maximum frequency.</td> </tr> <tr> <td>1</td> <td>Delta Freq</td> <td>Set the Acc/Dec time based on operating frequency.</td> </tr> </tbody> </table> <p>If, for example, maximum frequency is 60.00Hz, the Acc/Dec times are set to 5 seconds, and the frequency reference for operation is set at 30Hz (half of 60Hz), the time required to reach 30Hz therefore is 2.5 seconds (half of 5 seconds).</p> 	Configuration		Description	0	Max Freq	Set the Acc/Dec time based on maximum frequency.	1	Delta Freq	Set the Acc/Dec time based on operating frequency.			
Configuration		Description											
0	Max Freq	Set the Acc/Dec time based on maximum frequency.											
1	Delta Freq	Set the Acc/Dec time based on operating frequency.											
<p>bA.09 Time scale</p>	<p>Use the time scale for all time-related values. It is particularly useful when a more accurate Acc/Dec times are required because of load characteristics, or when the maximum time range needs to be extended.</p> <table border="1" data-bbox="364 1205 1236 1360"> <thead> <tr> <th colspan="2">Configuration</th> <th>Description</th> </tr> </thead> <tbody> <tr> <td>0</td> <td>0.01sec</td> <td>Sets 0.01 second as the minimum unit.</td> </tr> <tr> <td>1</td> <td>0.1sec</td> <td>Sets 0.1 second as the minimum unit.</td> </tr> <tr> <td>2</td> <td>1sec</td> <td>Sets 1 second as the minimum unit.</td> </tr> </tbody> </table>	Configuration		Description	0	0.01sec	Sets 0.01 second as the minimum unit.	1	0.1sec	Sets 0.1 second as the minimum unit.	2	1sec	Sets 1 second as the minimum unit.
Configuration		Description											
0	0.01sec	Sets 0.01 second as the minimum unit.											
1	0.1sec	Sets 0.1 second as the minimum unit.											
2	1sec	Sets 1 second as the minimum unit.											

⚠ Caution

Note that the range of maximum time values may change automatically when the units are changed. If for example, the acceleration time is set at 6000 seconds, a time scale change from 1 second to 0.01 second will result in a modified acceleration time of 60.00 seconds.

4.10.2 Acc/Dec Time Based on Operation Frequency

Acc/Dec times can be set based on the time required to reach the next step frequency from the existing operation frequency. To set the Acc/Dec time values based on the existing operation frequency, set bA. 08 (acc/dec reference) in the Basic group to 1 (Delta Freq).

Group	Code	Name	LCD Display	Parameter Setting	Setting Range	Unit
Operation	ACC	Acceleration time	AccTime	20.0	0.0-600.0	sec
	dEC	Deceleration time	Dec Time	30.0	0.0-600.0	sec
bA	08	Acc/Dec reference	Ramp T Mode	1 Delta Freq	0-1	-

Acc/Dec Time Based on Operation Frequency – Setting Details

Code	Description									
bA.08 Ramp T Mode	Set the parameter value to 1 (Delta Freq) to set Acc/Dec times based on Maximum frequency.									
	<table border="1"> <thead> <tr> <th colspan="2">Configuration</th> <th>Description</th> </tr> </thead> <tbody> <tr> <td>0</td> <td>Max Freq</td> <td>Set the Acc/Dec time based on Maximum frequency.</td> </tr> <tr> <td>1</td> <td>Delta Freq</td> <td>Set the Acc/Dec time based on Operation frequency.</td> </tr> </tbody> </table>	Configuration		Description	0	Max Freq	Set the Acc/Dec time based on Maximum frequency.	1	Delta Freq	Set the Acc/Dec time based on Operation frequency.
	Configuration		Description							
0	Max Freq	Set the Acc/Dec time based on Maximum frequency.								
1	Delta Freq	Set the Acc/Dec time based on Operation frequency.								
If Acc/Dec times are set to 5 seconds, and multiple frequency references are used in the operation in 2 steps, at 10Hz and 30 Hz, each acceleration stage will take 5 seconds (refer to the graph below).										

4.10.3 Multi-step Acc/Dec Time Configuration

Acc/Dec times can be configured via a multi-function terminal by setting the ACC (acceleration time) and dEC (deceleration time) codes in the Operation group.

Group	Code	Name	LCD Display	Parameter Setting	Setting Range	Unit	
Operation	ACC	Acceleration time	Acc Time	20.0	0.0–600.0	sec	
	dEC	Deceleration time	Dec Time	30.0	0.0–600.0	sec	
bA	70-82	Multi-step acceleration time1-7	Acc Time 1-7	x.xx	0.0–600.0	sec	
	71-83	Multi-step deceleration time1-7	Dec Time 1-7	x.xx	0.0–600.0	sec	
In	65-71	Px terminal configuration	Px Define (Px: P1–P7)	11	XCEL-L	0–54	-
				12	XCEL-M		
				49	XCEL-H		
	89	Multi-step command delay time	In Check Time	1	1–5000	ms	

Acc/Dec Time Setup via Multi-function Terminals – Setting Details

Code	Description												
bA.70–82 Acc Time 1–7	Set multi-step acceleration time1-7.												
bA.71–83 Dec Time 1–7	Set multi-step deceleration time1-7.												
In.65–71 Px Define (P1–P7)	Choose and configure the terminals to use for multi-step Acc/Dec time inputs.												
	<table border="1"> <thead> <tr> <th colspan="2">Configuration</th> <th>Description</th> </tr> </thead> <tbody> <tr> <td>11</td> <td>XCEL-L</td> <td>Acc/Dec command-L</td> </tr> <tr> <td>12</td> <td>XCEL-M</td> <td>Acc/Dec command-M</td> </tr> <tr> <td>49</td> <td>XCEL-H</td> <td>Acc/Dec command-H</td> </tr> </tbody> </table>	Configuration		Description	11	XCEL-L	Acc/Dec command-L	12	XCEL-M	Acc/Dec command-M	49	XCEL-H	Acc/Dec command-H
	Configuration		Description										
	11	XCEL-L	Acc/Dec command-L										
	12	XCEL-M	Acc/Dec command-M										
49	XCEL-H	Acc/Dec command-H											
Acc/Dec commands are recognized as binary code inputs and will control the acceleration and deceleration based on parameter values set with bA.70-82 and bA.71-83.													
If, for example, the P4 and P5 terminals are set as XCEL-L and XCEL respectively, the following operation will be available.													

Code	Description															
	<table border="1"> <thead> <tr> <th>Acc/Dec time</th> <th>P5</th> <th>P4</th> </tr> </thead> <tbody> <tr> <td>0</td> <td>-</td> <td>-</td> </tr> <tr> <td>1</td> <td>-</td> <td>✓</td> </tr> <tr> <td>2</td> <td>✓</td> <td>-</td> </tr> <tr> <td>3</td> <td>✓</td> <td>✓</td> </tr> </tbody> </table>	Acc/Dec time	P5	P4	0	-	-	1	-	✓	2	✓	-	3	✓	✓
Acc/Dec time	P5	P4														
0	-	-														
1	-	✓														
2	✓	-														
3	✓	✓														
In.89 In Check Time	Set the time for the inverter to check for other terminal block inputs. If In.89 is set to 100ms and a signal is supplied to the P4 terminal, the inverter searches for other inputs over the next 100ms. When the time expires, the Acc/Dec time will be set based on the input received at P4.															

4.10.4 Configuring Acc/Dec Time Switch Frequency

You can switch between two different sets of Acc/Dec times (Acc/Dec gradients) by configuring the switch frequency without configuring the multi-function terminals.

Group	Code	Name	LCD Display	Parameter Setting	Setting Range	Unit
Operation	ACC	Acceleration time	Acc Time	10.0	0.0-600.0	sec
	dEC	Deceleration time	Dec Time	10.0	0.0-600.0	sec
bA	70	Multi-step acceleration time1	Acc Time-1	20.0	0.0-600.0	sec
	71	Multi-step deceleration time1	Dec Time-1	20.0	0.0-600.0	sec
Ad	60	Acc/Dec time switch frequency	Xcel Change Frq	30.00	0-Maximum frequency	Hz

Acc/Dec Time Switch Frequency Setting Details

Code	Description
Ad.60 Xcel Change Fr	After the Acc/Dec switch frequency has been set, Acc/Dec gradients configured at bA.70 and 71 will be used when the inverter's operation frequency is at or below the switch frequency. If the operation frequency exceeds the switch frequency, the configured gradient level, configured for the ACC and dEC codes, will be used. If you configure the P1-P7 multi-function input terminals for multi-step Acc/Dec gradients (XCEL-L, XCEL-M, XCEL-H), the inverter will operate based on the Acc/Dec inputs at the terminals instead of the Acc/Dec switch frequency configurations.

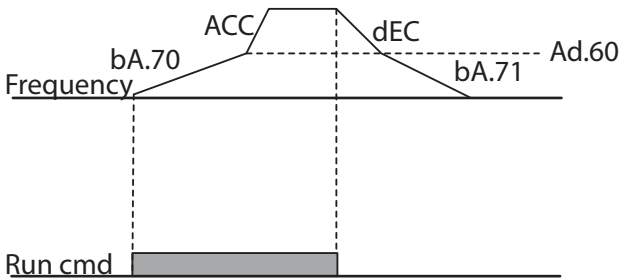

4.11 Acc/Dec Pattern Configuration

Acc/Dec gradient level patterns can be configured to enhance and smooth the inverter's acceleration and deceleration curves. Linear pattern features a linear increase or decrease to the output frequency, at a fixed rate. For an S-curve pattern a smoother and more gradual increase or decrease of output frequency, ideal for lift-type loads or elevator doors, etc. S-curve gradient level can be adjusted using codes Ad. 03-06 in the Advanced group.

Group	Code	Name	LCD Display	Parameter Setting		Setting Range	Unit
bA	08	Acc/Dec reference	Ramp T mode	0	Max Freq	0-1	-
Ad	01	Acceleration pattern	Acc Pattern	0	Linear	0-1	-
	02	Deceleration pattern	Dec Pattern	1	S-curve		-
	03	S-curve Acc start gradient	Acc S Start	40		1-100	%
	04	S-curve Acc end gradient	Acc S End	40		1-100	%
	05	S-curve Dec start gradient	Dec S Start	40		1-100	%
	06	S-curve Dec end gradient	Dec S End	40		1-100	%

Acc/Dec Pattern Setting Details

Code	Description
Ad.03 Acc S Start	<p>Sets the gradient level as acceleration starts when using an S-curve, Acc/Dec pattern. Ad. 03 defines S-curve gradient level as a percentage, up to half of total acceleration.</p> <p>If the frequency reference and maximum frequency are set at 60Hz and Ad.03 is set to 50%, Ad. 03 configures acceleration up to 30Hz (half of 60Hz).The inverter will operate S-curve acceleration in the 0-15Hz frequency range (50% of 30Hz). Linear acceleration will be applied to the remaining acceleration within the 15-30Hz frequency range.</p>
Ad.04 Acc S End	<p>Sets the gradient level as acceleration ends when using an S-curve Acc/Dec pattern. Ad. 03 defines S-curve gradient level as a percentage, above half of total acceleration.</p> <p>If the frequency reference and the maximum frequency are set at 60Hz and Ad.04 is set to 50%, setting Ad. 04 configures acceleration to increase from 30Hz (half of 60Hz) to 60Hz (end of acceleration). Linear acceleration will be applied within the 30-45Hz frequency range. The inverter will perform an S-curve acceleration for the remaining acceleration in the 45-60Hz frequency range.</p>
Ad.05 Dec S Start – Ad.06 Dec S End	<p>Sets the rate of S-curve deceleration. Configuration for codes Ad.05 and Ad.06 may be performed the same way as configuring codes Ad.03 and Ad.04.</p>

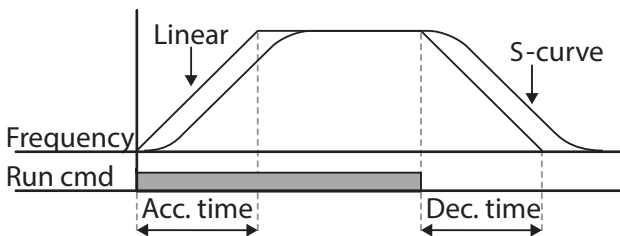

[Acceleration / deceleration pattern configuration]

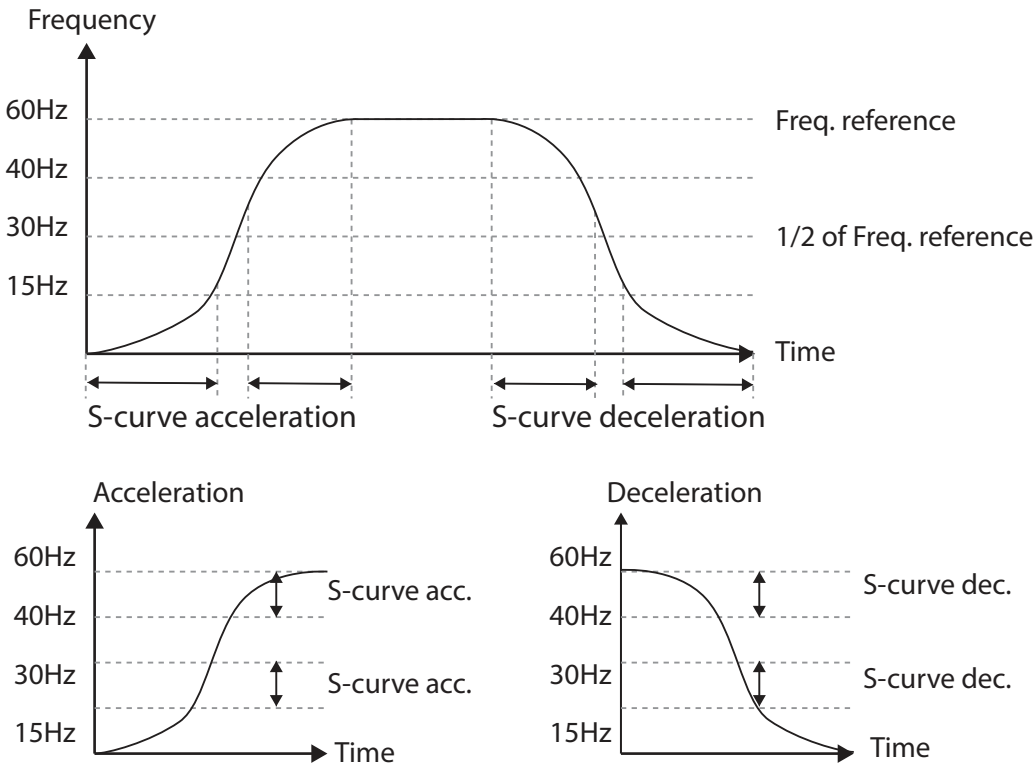

[Acceleration / deceleration S-curve parthen configuration]

Note

The Actual Acc/Dec time during an S-curve application

Actual acceleration time = user-configured acceleration time + user-configured acceleration time x starting gradient level/2 + user-configured acceleration time x ending gradient level/2.

Actual deceleration time = user-configured deceleration time + user-configured deceleration time x starting gradient level/2 + user-configured deceleration time x ending gradient level/2.

Caution

Note that actual Acc/Dec times become greater than user defined Acc/Dec times when S-curve Acc/Dec patterns are in use.

4.12 Stopping the Acc/Dec Operation

Configure the multi-function input terminals to stop acceleration or deceleration and operate the inverter at a fixed frequency.

Group	Code	Name	LCD Display	Parameter Setting		Setting Range	Unit
In	65-71	Px terminal configuration	Px Define(Px: P1-P7)	25	XCEL Stop	0-54	-

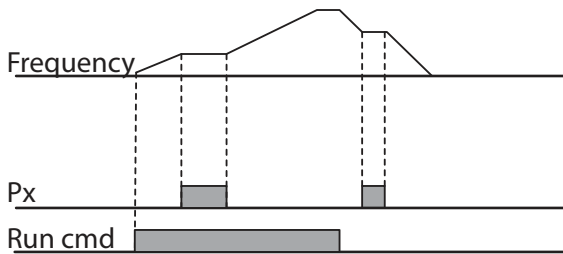

4.13 V/F(Voltage/Frequency) Control

Configure the inverter's output voltages, gradient levels and output patterns to achieve a target output frequency with V/F control. The amount of torque boost used during low frequency operations can also be adjusted.

4.13.1 Linear V/F Pattern Operation

A linear V/F pattern configures the inverter to increase or decrease the output voltage at a fixed rate for different operation frequencies based on V/F characteristics. A linear V/F pattern is particularly useful when a constant torque load is applied.

Group	Code	Name	LCD Display	Parameter Setting		Setting Range	Unit
In	09	Control mode	Control Mode	0	V/F	0-4	-
	18	Base frequency	Base Freq	60.00		30.00-400.00	Hz
	19	Start frequency	Start Freq	0.50		0.01-10.00	Hz
bA	07	V/F pattern	V/F Pattern	0	Linear	0-3	-

Linear V/F Pattern Setting Details

Code	Description
dr.18 Base Freq	Sets the base frequency. A base frequency is the inverter's output frequency when running at its rated voltage. Refer to the motor's rating plate to set this parameter value.
dr.19 Start Freq	<p>Sets the start frequency. A start frequency is a frequency at which the inverter starts voltage output. The inverter does not produce output voltage while the frequency reference is lower than the set frequency. However, if a deceleration stop is made while operating above the start frequency, output voltage will continue until the operation frequency reaches a full-stop (0Hz).</p>

4.13.2 Square Reduction V/F pattern Operation

Square reduction V/F pattern is ideal for loads such as fans and pumps. It provides non-linear acceleration and deceleration patterns to sustain torque throughout the whole frequency range.

Group	Code	Name	LCD Display	Parameter Setting	Setting Range	Unit	
bA	07	V/F pattern	V/F Pattern	1	Square	0-3	-
				3	Square2		

Square Reduction V/F pattern Operation - Setting Details

Code	Description						
bA.07 V/F Pattern	Sets the parameter value to 1(Square) or 3(Square2) according to the load's start characteristics.						
	<table border="1"> <thead> <tr> <th>Setting</th> <th>Function</th> </tr> </thead> <tbody> <tr> <td>1</td> <td>Square</td> </tr> <tr> <td>3</td> <td>Square2</td> </tr> </tbody> </table>	Setting	Function	1	Square	3	Square2
	Setting	Function					
1	Square						
3	Square2						
<p>The inverter produces output voltage proportional to 1.5 square of the operation frequency.</p> <p>The inverter produces output voltage proportional to 2 square of the operation frequency. This setup is ideal for variable torque loads such as fans or pumps.</p>							

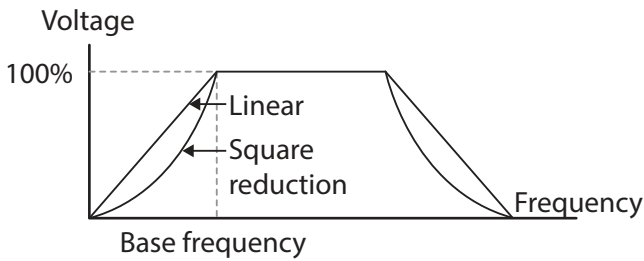

4.13.3 User V/F Pattern Operation

The S100 inverter allows the configuration of user-defined V/F patterns to suit the load characteristics of special motors.

Group	Code	Name	LCD Display	Parameter Setting	Setting Range	Unit
bA	07	V/F pattern	V/F Pattern	2 User V/F	0-3	-
	41	User Frequency1	User Freq 1	15.00	0-Maximum frequency	Hz
	42	User Voltage1	User Volt 1	25	0-100	%
	43	User Frequency2	User Freq 2	30.00	0-Maximum frequency	Hz
	44	User Voltage2	User Volt 2	50	0-100	%
	45	User Frequency3	User Freq 3	45.00	0-Maximum frequency	Hz
	46	User Voltage3	User Volt 3	75	0-100	%
	47	User Frequency4	User Freq 4	Maximum frequency	0-Maximum frequency	Hz
	48	User Voltage4	User Volt 4	100	0-100%	%

User V/F pattern Setting Details

Code	Description
bA.41 User Freq 1– bA.48 User Volt 4	Set the parameter values to assign arbitrary frequencies (User Freq 1-4) for start and maximum frequencies. Voltages can also be set to correspond with each frequency, and for each user voltage (User Volt 1-4).

The 100% output voltage in the figure below is based on the parameter settings of bA.15 (motor rated voltage). If bA.15 is set to 0 it will be based on the input voltage.

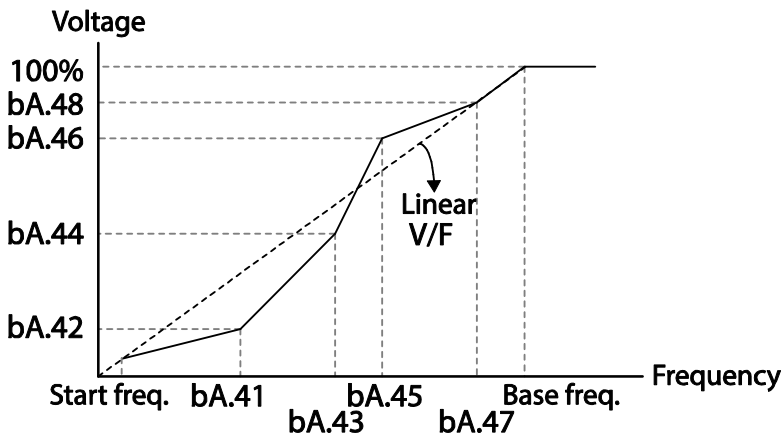

⚠ Caution

- When a normal induction motor is in use, care must be taken not to configure the output pattern away from a linear V/F pattern. Non-linear V/F patterns may cause insufficient motor torque or motor overheating due to over-excitation.
- When a user V/F pattern is in use, forward torque boost (dr.16) and reverse torque boost (dr.17) do not operate.

4.14 Torque Boost

4.14.1 Manual Torque Boost

Manual torque boost enables users to adjust output voltage during low speed operation or motor start. Increase low speed torque or improve motor starting properties by manually increasing output voltage. Configure manual torque boost while running loads that require high starting torque, such as lift-type loads.

Group	Code	Name	LCD Display	Parameter Setting	Setting Range	Unit
Dr	15	Torque boost options	Torque Boost	0 Manual	0–1	-
	16	Forward torque boost	Fwd Boost	2.0	0.0–15.0	%
	17	Reverse torque boost	Rev Boost	2.0	0.0–15.0	%

Manual Torque Boost Setting Details

Code	Description
dr.16 Fwd Boost	Set torque boost for forward operation.
dr.17 Rev Boost	Set torque boost for reverse operation.

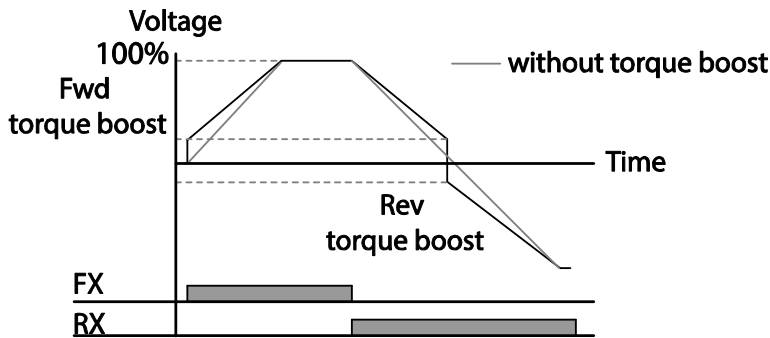

Caution

Excessive torque boost will result in over-excitation and motor overheating .

4.14.2 Auto Torque Boost

Auto torque boost enables the inverter to automatically calculate the amount of output voltage required for torque boost based on the entered motor parameters. Because auto torque boost requires motor-related parameters such as stator resistance, inductance, and no-load current, auto tuning (bA.20) has to be performed before auto torque boost can be configured [Refer to [5.9 Auto Tuning](#) on page 144]. Similarly to manual torque boost, configure auto torque boost while running a load that requires high starting torque, such as lift-type loads.

Group	Code	Name	LCD Display	Parameter Setting	Setting Range	Unit
Dr	15	torque boost mode	Torque Boost	1 Auto	0-1	-
bA	20	auto tuning	Auto Tuning	3 Rs+Lsigma	0-6	-

4.15 Output Voltage Setting

Output voltage settings are required when a motor's rated voltage differs from the input voltage to the inverter. Set bA.15 to configure the motor's rated operating voltage. The set voltage

becomes the output voltage of the inverter's base frequency. When the inverter operates above the base frequency, and when the motor's voltage rating is lower than the input voltage at the inverter, the inverter adjusts the voltage and supplies the motor with the voltage set at bA.15 (motor rated voltage). If the motor's rated voltage is higher than the input voltage at the inverter, the inverter will supply the inverter input voltage to the motor.

If bA.15 (motor rated voltage) is set to 0, the inverter corrects the output voltage based on the input voltage in the stopped condition. If the frequency is higher than the base frequency, when the input voltage is lower than the parameter setting, the input voltage will be the inverter output voltage.

Group	Code	Name	LCD Display	Parameter Setting	Setting Range	Unit
bA	15	Motor rated voltage	Rated Volt	0	0, 170-480	V

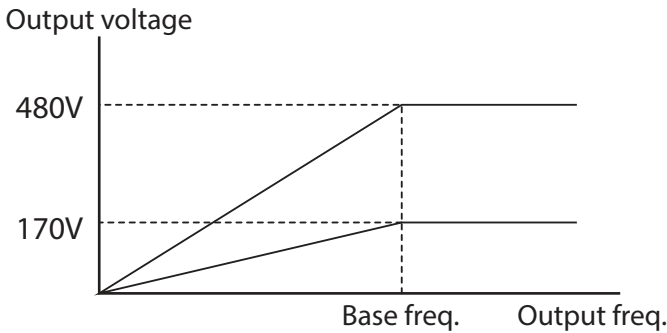

4.16 Start Mode Setting

Select the start mode to use when the operation command is input with the motor in the stopped condition.

4.16.1 Acceleration Start

Acceleration start is a general acceleration mode. If there are no extra settings applied, the motor accelerates directly to the frequency reference when the command is input.

Group	Code	Name	LCD Display	Parameter Setting	Setting Range	Unit
Ad	07	Start mode	Start mode	0 Acc	0-1	-

4.16.2 Start After DC Braking

This start mode supplies a DC voltage for a set amount of time to provide DC braking before an inverter starts to accelerate a motor. If the motor continues to rotate due to its inertia, DC braking will stop the motor, allowing the motor to accelerate from a stopped condition. DC braking can also be used with a mechanical brake connected to a motor shaft when a constant torque load is applied, if a constant torque is required after the the mechanical brake is released.

Group	Code	Name	LCD Display	Parameter Setting	Setting Range	Unit
Ad	07	Start mode	Start Mode	1 DC-Start	0-1	-
	12	Start DC braking time	DC-Start Time	0.00	0.00-60.00	sec
	13	DC Injection Level	DC Inj Level	50	0-200	%

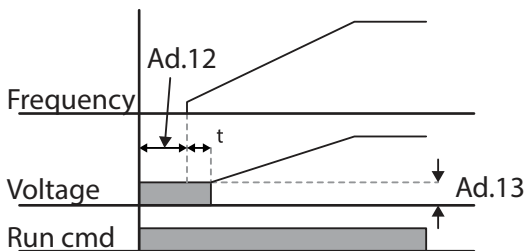

⚠ Caution

The amount of DC braking required is based on the motor's rated current. Do not use DC braking resistance values that can cause current draw to exceed the rated current of the inverter. If the DC braking resistance is too high or brake time is too long, the motor may overheat or be damaged.

4.17 Stop Mode Setting

Select a stop mode to stop the inverter operation.

4.17.1 Deceleration Stop

Deceleration stop is a general stop mode. If there are no extra settings applied, the motor decelerates down to 0Hz and stops, as shown in the figure below.

Group	Code	Name	LCD Display	Parameter Setting	Setting Range	Unit
Ad	08	Stop mode	Stop Mode	0 Dec	0-4	-

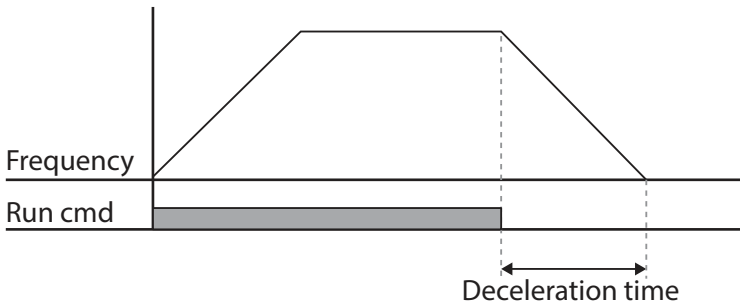

4.17.2 Stop After DC Braking

When the operation frequency reaches the set value during deceleration (DC braking frequency), the inverter stops the motor by supplying DC power to the motor. With a stop command input, the inverter begins decelerating the motor. When the frequency reaches the DC braking frequency set at Ad.17, the inverter supplies DC voltage to the motor and stops it.

Group	Code	Name	LCD Display	Parameter Setting		Setting Range	Unit
Ad	08	Stop mode	Stop Mode	0	Dec	0-4	-
	14	Output block time before braking	DC-Block Time	0.10		0.00-60.00	sec
	15	DC braking time	DC-Brake Time	1.00		0-60	sec
	16	DC braking amount	DC-Brake Level	50		0-200	%
	17	DC braking frequency	DC-Brake Freq	5.00		0.00-60.00	Hz

DC Braking After Stop Setting Details

Code	Description
Ad.14 DC-Block Time	Set the time to block the inverter output before DC braking. If the inertia of the load is great, or if DC braking frequency (Ad.17) is set too high, a fault trip may occur due to overcurrent conditions when the inverter supplies DC voltage to the motor. Prevent overcurrent fault trips by adjusting the output block time before DC braking.
Ad.15 DC-Brake Time	Set the time duration for the DC voltage supply to the motor.
Ad.16 DC-Brake Level	Set the amount of DC braking to apply. The parameter setting is based on the rated current of the motor.
Ad.17 DC-Brake Freq	Set the frequency to start DC braking. When the frequency is reached, the inverter starts deceleration. If the dwell frequency is set lower than the DC braking frequency, dwell operation will not work and DC braking will start instead.

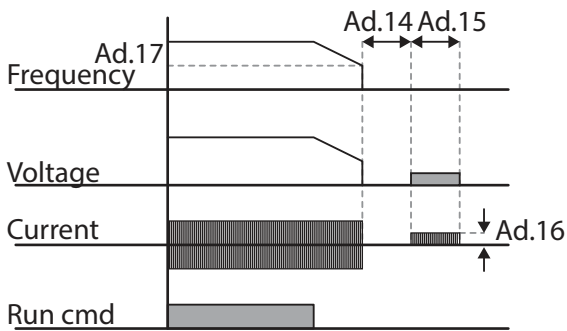

Caution

- Note that the motor can overheat or be damaged if excessive amount of DC braking is applied to the motor, or DC braking time is set too long.
- DC braking is configured based on the motor’s rated current. To prevent overheating or damaging motors, do not set the current value higher than the inverter’s rated current.

4.17.3 Free Run Stop

When the Operation command is off, the inverter output turns off, and the load stops due to residual inertia.

Group	Code	Name	LCD Display	Parameter Setting	Setting Range	Unit
Ad	08	Stop Method	Stop Mode	2	Free-Run	0-4

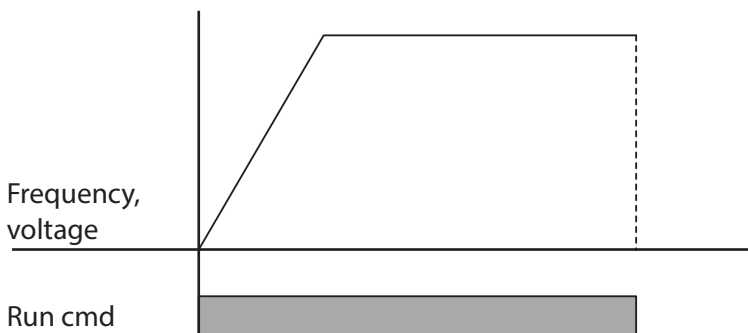

Caution

Note that when there is high inertia on the output side and the motor is operating at high speed, the load's inertia will cause the motor to continue rotating even if the inverter output is blocked.

4.17.4 Power Braking

When the inverter's DC voltage rises above a specified level due to motor regenerated energy, a control is made to either adjust the deceleration gradient level or reaccelerate the motor in order to reduce the regenerated energy. Power braking can be used when short deceleration times are needed without brake resistors, or when optimum deceleration is needed without causing an over voltage fault trip.

Group	Code	Name	LCD Display	Parameter Setting	Setting Range	Unit	
Ad	08	Stop mode	Stop Mode	4	Power Braking	0–4	-

Caution

- To prevent overheating or damaging the motor, do not apply power braking to the loads that require frequent deceleration.
- Stall prevention and power braking only operate during deceleration, and power braking takes priority over stall prevention. In other words, when both Pr.50 (stall prevention and flux braking) and Ad.08 (power braking) are set, power braking will take precedence and operate.
- Note that if deceleration time is too short or inertia of the load is too great, an overvoltage fault trip may occur.
- Note that if a free run stop is used, the actual deceleration time can be longer than the pre-set deceleration time.

4.18 Frequency Limit

Operation frequency can be limited by setting maximum frequency, start frequency, upper limit frequency and lower limit frequency.

4.18.1 Frequency Limit Using Maximum Frequency and Start Frequency

Group	Code	Name	LCD Display	Parameter Setting	Setting Range	Unit
dr	19	Start frequency	Start Freq	0.50	0.01-10.00	Hz
	20	Maximum frequency	Max Freq	60.00	40.00-400.00	Hz

Frequency Limit Using Maximum Frequency and Start Frequency - Setting Details

Code	Description
dr.19 Start Freq	Set the lower limit value for speed unit parameters that are expressed in Hz or rpm. If an input frequency is lower than the start frequency, the parameter value will be 0.00.
dr.20 Max Freq	Set upper and lower frequency limits. All frequency selections are restricted to frequencies from within the upper and lower limits. This restriction also applies when you in input a frequency reference using the keypad.

4.18.2 Frequency Limit Using Upper and Lower Limit Frequency Values

Group	Code	Name	LCD Display	Parameter Setting	Setting Range	Unit
Ad	24	Frequency limit	Freq Limit	0 No	0-1	-
	25	Frequency lower limit value	Freq Limit Lo	0.50	0.0-maximum frequency	Hz
	26	Frequency upper limit value	Freq Limit Hi	Maximum frequency	minimum-maximum frequency	Hz

Frequency Limit Using Upper and Lower Limit Frequencies - Setting Details

Code	Description
Ad.24 Freq Limit	The initial setting is 0(No). Changing the setting to 1(Yes) allows the setting of frequencies between the lower limit frequency (Ad.25) and the upper limit frequency (Ad.26). When the setting is 0(No), codes Ad.25 and Ad.26 are not visible.
Ad.25 Freq Limit Lo, Ad.26 Freq Limit Hi	Set an upper limit frequency to all speed unit parameters that are expressed in Hz or rpm, except for the base frequency (dr.18). Frequency cannot be set higher than the upper limit frequency.

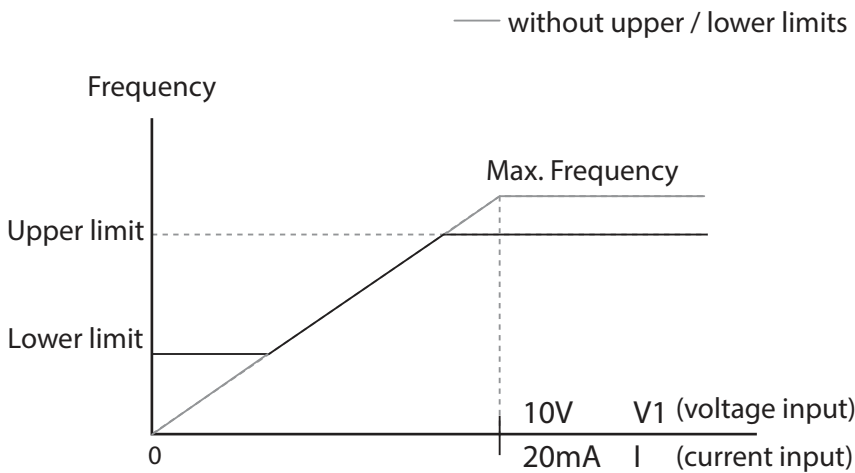

4.18.3 Frequency Jump

Use frequency jump to avoid mechanical resonance frequencies. Jump through frequency bands when a motor accelerates and decelerates. Operation frequencies cannot be set within the pre-set frequency jump band.

When a frequency setting is increased, while the frequency parameter setting value (voltage, current, RS-485 communication, keypad setting, etc.) is within a jump frequency band, the frequency will be maintained at the lower limit value of the frequency band. Then, the frequency will increase when the frequency parameter setting exceeds the range of frequencies used by the frequency jump band.

Group	Code	Name	LCD Display	Parameter Setting		Setting Range	Unit
Ad	27	Frequency jump	Jump Freq	0	No	0-1	-
	28	Jump frequency lower limit1	Jump Lo 1	10.00		0.00-Jump frequency upper limit 1	Hz

Group	Code	Name	LCD Display	Parameter Setting	Setting Range	Unit
	29	Jump frequency upper limit 1	Jump Hi 1	15.00	Jump frequency lower limit 1-Maximum frequency	Hz
	30	Jump frequency lower limit 2	Jump Lo 2	20.00	0.00-Jump frequency upper limit 2	Hz
	31	Jump frequency upper limit 2	Jump Hi 2	25.00	Jump frequency lower limit 2-Maximum frequency	Hz
	32	Jump frequency lower limit 3	Jump Lo 3	30.00	0.00-Jump frequency upper limit 3	Hz
	33	Jump frequency upper limit 3	Jump Hi 3	35.00	Jump frequency lower limit 3-Maximum frequency	Hz

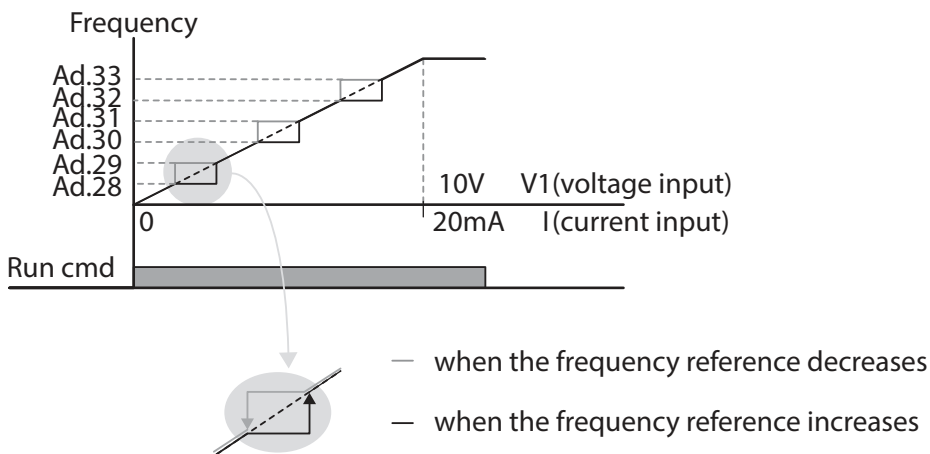

4.19 2nd Operation Mode Setting

Apply two types of operation modes and switch between them as required. For both the first and second command source, set the frequency after shifting operation commands to the multi-function input terminal. Mode switching can be used to stop remote control during an operation using the communication option and to switch operation mode to operate via the local panel, or to operate the inverter from another remote control location.

Select one of the multi-function terminals from codes In. 65-71 and set the parameter value to 15 (2nd Source).

Group	Code	Name	LCD Display	Parameter Setting	Setting Range	Unit
Opera tion	drv	Command source	Cmd Source*	1 Fx/Rx-1	0-4	-
	Frq	Frequency reference source	Freq Ref Src	2 V1	0-12	-

Group	Code	Name	LCD Display	Parameter Setting		Setting Range	Unit
bA	04	2 nd Command source	Cmd 2nd Src	0	Keypad	0–4	-
	05	2 nd Frequency reference source	Freq 2nd Src	0	KeyPad-1	0–12	-
In	65-71	Px terminal configuration	Px Define (Px: P1-P7)	15	2nd Source	0–54	-

* Displayed under DRV-06 in an LCD keypad.

2nd Operation Mode Setting Details

Code	Description
bA.04 Cmd 2nd Src bA.05 Freq 2nd Src	If signals are provided to the multi-function terminal set as the 2 nd command source (2nd Source), the operation can be performed using the set values from bA.04-05 instead of the set values from the drv and Frq codes in the Operation group. The 2nd command source settings cannot be changed while operating with the 1 st command source (Main Source).

Caution

- When setting the multi-function terminal to the 2nd command source (2nd Source) and input (On) the signal, operation state is changed because the frequency setting and the Operation command will be changed to the 2nd command. Before shifting input to the multi-function terminal, ensure that the 2nd command is correctly set. Note that if the deceleration time is too short or inertia of the load is too high, an overvoltage fault trip may occur.
- Depending on the parameter settings, the inverter may stop operating when you switch the command modes.

4.20 Multi-function Input Terminal Control

























Filter time constants and the type of multi-function input terminals can be configured to improve the response of input terminals

Group	Code	Name	LCD Display	Parameter Setting	Setting Range	Unit
In	85	Multi-function input terminal On filter	DI On Delay	10	0-10000	ms
	86	Multi-function input terminal Off filter	DI Off Delay	3	0-10000	ms
	87	Multi-function input terminal selection	DI NC/NO Sel	0 0000*	-	-

Group	Code	Name	LCD Display	Parameter Setting	Setting Range	Unit
	90	Multi-function input terminal status	DI Status	0 0000*	-	-

* Displayed as  on the keypad.

Multi-function Input Terminal Control Setting Details

Code	Description									
In.85 DI On Delay, In.86 DI Off Delay	If the input terminal's state is not changed during the set time, when the terminal receives an input, it is recognized as On or Off.									
In.87 DI NC/NO Sel	<p>Select terminal contact types for each input terminal. The position of the indicator light corresponds to the segment that is on as shown in the table below. With the bottom segment on, it indicates that the terminal is configured as a A terminal (Normally Open) contact. With the top segment on, it indicates that the terminal is configured as a B terminal (Normally Closed) contact. Terminals are numbered P1-P7, from right to left.</p> <table border="1"> <thead> <tr> <th>Type</th> <th>B terminal status (Normally Closed)</th> <th>A terminal status (Normally Open)</th> </tr> </thead> <tbody> <tr> <td>Keypad</td> <td></td> <td></td> </tr> <tr> <td>LCD keypad</td> <td></td> <td></td> </tr> </tbody> </table>	Type	B terminal status (Normally Closed)	A terminal status (Normally Open)	Keypad			LCD keypad		
Type	B terminal status (Normally Closed)	A terminal status (Normally Open)								
Keypad										
LCD keypad										
In.90 DI Status	<p>Display the configuration of each contact. When a segment is configured as A terminal using dr.87, the On condition is indicated by the top segment turning on. The Off condition is indicated when the bottom segment is turned on. When contacts are configured as B terminals, the segment lights behave conversely. Terminals are numbered P1-P7, from right to left.</p> <table border="1"> <thead> <tr> <th>Type</th> <th>A terminal setting (On)</th> <th>A terminal setting (Off)</th> </tr> </thead> <tbody> <tr> <td>Keypad</td> <td></td> <td></td> </tr> <tr> <td>LCD keypad</td> <td></td> <td></td> </tr> </tbody> </table>	Type	A terminal setting (On)	A terminal setting (Off)	Keypad			LCD keypad		
Type	A terminal setting (On)	A terminal setting (Off)								
Keypad										
LCD keypad										

4.21 P2P Setting

The P2P function is used to share input and output devices between multiple inverters. To enable P2P setting, RS-485 communication must be turned on .

Inverters connected through P2P communication are designated as either a master or slaves. The Master inverter controls the input and output of slave inverters. Slave inverters provide input and output actions. When using the multi-function output, a slave inverter can select to use either the master inverter's output or its own output. When using P2P communication, first designate the slave inverter and then the master inverter. If the master inverter is designated first, connected inverters may interpret the condition as a loss of communication.

Master Parameter

Group	Code	Name	LCD Display	Parameter Setting		Setting Range	Unit
CM	95	P2P Communication selection	Int 485 Func	1	P2P Master	0-3	-
US	80	Analog input1	P2P In V1	0		0-12,000	%
	81	Analog input2	P2P In I2	0		-12,000-12,000	%
	82	Digital input	P2P In DI	0		0-0x7F	bit
	85	Analog output	P2P Out AO1	0		0-10,000	%
	88	Digital output	P2P Out DO	0		0-0x03	bit

Slave Parameter

Group	Code	Name	LCD Display	Parameter Setting		Setting Range	Unit
CM	95	P2P Communication selection	Int 485 Func	2	P2P Slave	0-3	-
	96	P2P DO setting selection	P2P OUT Sel	0	No	0-2	bit

P2P Setting Details

Code	Description
CM.95 Int 485 Func	Set master inverter to 1(P2P Master), slave inverter to 2(P2P Slave).
US.80-82 P2P Input Data	Input data sent from the slave inverter.
US.85, 88 P2P Output Data	Output data transmitted to the slave inverter.

Caution

- P2P features work only with code version 1.00, IO S/W version 0.11, and keypad S/W version 1.07 or higher versions.
- Set the user sequence functions to use P2P features..

4.22 Multi-keypad Setting

Use multi-keypad settings to control more than one inverter with one keypad. To use this function, first configure RS-485 communication.

The group of inverters to be controlled by the keypad will include a master inverter. The master inverter monitors the other inverters, and slave inverter responds to the master inverter's input. When using multi-function output, a slave inverter can select to use either the master inverter's output or its own output. When using the multi keypad, first designate the slave inverter and then the master inverter. If the master inverter is designated first, connected inverters may interpret the condition as a loss of communication.

Master Parameter

Group	Code	Name	LCD Display	Parameter Setting		Setting Range	Unit
CM	95	P2P Communication selection	Int 485 Func	3	KPD-Ready	0-3	-
CNF	03	Multi-keypad ID	Multi KPD ID	3		3-99	-
	42	Multi-function key selection	Multi Key Sel	4	Multi KPD	0-4	-

Slave Parameter

Group	Code	Name	LCD Display	Parameter Setting		Setting Range	Unit
CM	01	Station ID	Int485 St ID	3		3-99	-
	95	P2P communication options	Int 485 Func	3	KPD-Ready	0-3	-

Multi-keypad Setting Details

Code	Description
CM.01 Int485 St ID	Prevents conflict by designating a unique identification value to an inverter. Values can be selected from numbers between 3-99.
CM.95 Int 485 Func	Set the value to 3(KPD-Ready) for both master and slave inverter
CNF-03 Multi KPD ID	Select an inverter to monitor from the group of inverters.
CNF-42 Multi key Sel	Select a multi-function key type 4(Multi KPD).

⚠ Caution

- Multi-keypad (Multi-KPD) features work only with code version 1.00, IO S/W version 0.11, and keypad S/W version 1.07 or higher versions.
- The multi-keypad feature will not work when the multi-keypad ID (CNF-03 Multi-KPD ID) setting is identical to the RS-485 communication station ID (CM-01 Int485 st ID) setting.
- The master/slave setting cannot be changed while the inverter is operating in slave mode.

4.23 User Sequence Setting

User Sequence creates a simple sequence from a combination of different function blocks. The sequence can comprise of a maximum of 18 steps using 29 function blocks and 30 void parameters.

1 Loop refers to a single execution of a user configured sequence that contains a maximum of 18 steps. Users can select a Loop Time of between 10-1,000ms.

The codes for user sequences configuration can be found in the US group (for user sequence settings) and the UF group (for function block settings).

Group	Code	Name	LCD Display	Parameter Setting	Setting Range	Unit
AP	02	User sequence activation	User Seq En	0	0-1	-
US	01	User sequence operation command	User Seq Con	0	0-2	-
	02	User sequence operation time	User Loop Time	0	0-5	-
	11-28	Output address link1-18	Link UserOut1-18	0	0-0xFFFF	-
	31-60	Input value setting1-30	Void Para1-30	0	-9999-9999	-
	80	Analog input 1	P2P In V1(-10-10 V)	0	0-12,000	%
	81	Analog input 2	P2P In I2	0	-12,000	%
	82	Digital input	P2P In D	0	-12,000	bit
	85	Analog output	P2P Out AO1	0	0-0x7F	%
	88	Digital output	P2P Out DO	0	0-0x03	bit
UF	01	User function 1	User Func1	0	0-28	-
	02	User function input 1-A	User Input 1-A	0	0-0xFFFF	-
	03	User function input 1-B	User Input 1-B	0	0-0xFFFF	-
	04	User function input 1-C	User Input 1-C	0	0-0xFFFF	-
	05	User function output 1	User Output 1	0	-32767-32767	-
	06	User function 2	User Func2	0	0-28	-
	07	User function input 2-A	User Input 2-A	0	0-0xFFFF	-
	08	User function input 2-B	User Input 2-B	0	0-0xFFFF	-
	09	User function input 2-C	User Input 2-C	0	0-0xFFFF	-
	10	User function output 2	User Output 2	0	-32767-32767	-
	11	User function 3	User Func3	0	0-28	-
	12	User function input 3-A	User Input 3-A	0	0-0xFFFF	-
	13	User function input 3-B	User Input 3-B	0	0-0xFFFF	-

Group	Code	Name	LCD Display	Parameter Setting	Setting Range	Unit
	14	User function input 3-C	User Input 3-C	0	0-0xFFFF	-
	15	User function output 3	User Output 3	0	-32767-32767	-
	16	User function 4	User Func4	0	0-28	-
	17	User function input 4-A	User Input 4-A	0	0-0xFFFF	-
	18	User function input 4-B	User Input 4-B	0	0-0xFFFF	-
	19	User function input 4-C	User Input 4-C	0	0-0xFFFF	-
	20	User function output 4	User Output 4	0	-32767-32767	-
	21	User function 5	User Func5	0	0-28	-
	22	User function input 5-A	User Input 5-A	0	0-0xFFFF	-
	23	User function input 5-B	User Input 5-B	0	0-0xFFFF	-
	24	User function input 5-C	User Input 5-C	0	0-0xFFFF	-
	25	User function output 5	User Output 5	0	-32767-32767	-
	26	User function 6	User Func6	0	0-28	-
	27	User function input 6-A	User Input 6-A	0	0-0xFFFF	-
	28	User function input 6-B	User Input 6-B	0	0-0xFFFF	-
	29	User function input 6-C	User Input 6-C	0	0-0xFFFF	-
	30	User function output 6	User Output 6	0	-32767-32767	-
	31	User function 7	User Func7	0	0-28	-
	32	User function input 7-A	User Input 7-A	0	0-0xFFFF	-
	33	User function input 7-B	User Input 7-B	0	0-0xFFFF	-
	34	User function input 7-C	User Input 7-C	0	0-0xFFFF	-
	35	User function output 7	User Output 7	0	-32767-32767	-
	36	User function 8	User Func8	0	0-28	-
	37	User function input 8-A	User Input 8-A	0	0-0xFFFF	-
	38	User function input 8-B	User Input 8-B	0	0-0xFFFF	-
	39	User function input 8-C	User Input 8-C	0	0-0xFFFF	-
	40	User function output 8	User Output 8	0	-32767-32767	-
	41	User function 9	User Func9	0	0-28	-
	42	User function input 9-A	User Input 9-A	0	0-0xFFFF	-
	43	User function input 9-B	User Input 9-B	0	0-0xFFFF	-
	44	User function input 9-C	User Input 9-C	0	0-0xFFFF	-
	45	User function output 9	User Output 9	0	-32767-32767	-
	46	User function 10	User Func10	0	0-28	-
	47	User function input 10-A	User Input 10-A	0	0-0xFFFF	-
	48	User function input 10-B	User Input 10-B	0	0-0xFFFF	-

Group	Code	Name	LCD Display	Parameter Setting	Setting Range	Unit
	49	User function input 10-C	User Input 10-C	0	0-0xFFFF	-
	50	User function output 10	User Output 10	0	-32767-32767	-
	51	User function 11	User Func11	0	0-28	-
	52	User function input 11-A	User Input 11-A	0	0-0xFFFF	-
	53	User function input 11-B	User Input 11-B	0	0-0xFFFF	-
	54	User function input 11-C	User Input 11-C	0	0-0xFFFF	-
	55	User function output 11	User Output 11	0	-32767-32767	-
	56	User function 12	User Func12	0	0-28	-
	57	User function input 12-A	User Input 12-A	0	0-0xFFFF	-
	58	User function input 12-B	User Input 12-B	0	0-0xFFFF	-
	59	User function input 12-C	User Input 12-C	0	0-0xFFFF	-
	60	User function output 12	User Output 12	0	-32767-32767	-
	61	User function 13	User Func13	0	0-28	-
	62	User function input 13-A	User Input 13-A	0	0-0xFFFF	-
	63	User function input 13-B	User Input 13-B	0	0-0xFFFF	-
	64	User function input 13-C	User Input 13-C	0	0-0xFFFF	-
	65	User function output 13	User Output 13	0	-32767-32767	-
	66	User function 14	User Func14	0	0-28	-
	67	User function input 14-A	User Input 14-A	0	0-0xFFFF	-
	68	User function input 14-B	User Input 14-B	0	0-0xFFFF	-
	69	User function input 14-C	User Input 14-C	0	0-0xFFFF	-
	70	User function output 14	User Output 14	0	-32767-32767	-
	71	User function 15	User Func15	0	0-28	-
	72	User function input 15-A	User Input 15-A	0	0-0xFFFF	-
	73	User function input 15-B	User Input 15-B	0	0-0xFFFF	-
	74	User function input 15-C	User Input 15-C	0	0-0xFFFF	-
	75	User function output 15	User Output 15	0	-32767-32767	-
	76	User function 16	User Func16	0	0-28	-
	77	User function input 16-A	User Input 16-A	0	0-0xFFFF	-
	78	User function input 16-B	User Input 16-B	0	0-0xFFFF	-
	79	User function input 16-C	User Input 16-C	0	0-0xFFFF	-
	80	User function output 16	User Output 16	0	-32767-32767	-
	81	User function 17	User Func17	0	0-28	-
	82	User function input 17-A	User Input 17-A	0	0-0xFFFF	-
	83	User function input 17-B	User Input 17-B	0	0-0xFFFF	-

Group	Code	Name	LCD Display	Parameter Setting	Setting Range	Unit
	84	User function input 17-C	User Input 17-C	0	0-0xFFFF	-
	85	User function output 17	User Output 17	0	-32767-32767	-
	86	User function 18	User Func18	0	0-28	-
	87	User function input 18-A	User Input 18-A	0	0-0xFFFF	-
	88	User function input 18-B	User Input 18-B	0	0-0xFFFF	-
	89	User function input 18-C	User Input 18-C	0	0-0xFFFF	-
	90	User function output 18	User Output 18	0	-32767-32767	-

User Sequence Setting Details

Code	Description
AP.02 User Seq En	Display the parameter groups related to a user sequence.
US.01 User Seq Con	Set Sequence Run and Sequence Stop with the keypad. Parameters cannot be adjusted during an operation. To adjust parameters, the operation must be stopped.
US.02 User Loop Time	Set the user sequence Loop Time. User sequence loop time can be set to 0.01s/0.02s/ 0.05s/0.1s/0.5s/1s.
US.11-28 Link UserOut1-18	Set parameters to connect 18 Function Blocks. If the input value is 0x0000, an output value cannot be used. To use the output value in step 1 for the frequency reference (Cmd Frequency), input the communication address(0x1101) of the Cmd frequency as the Link UserOut1 parameter.
US.31-60 Void Para1-30	Set 30 void parameters. Use when constant (Const) parameter input is needed in the user function block.
UF.01-90	Set user defined functions for the 18 function blocks. If the function block setting is invalid, the output of the User Output@ is -1. All the outputs from the User Output@ are read only, and can be used with the user output link@ (Link UserOut@) of the US group.

Function Block Parameter Structure

Type	Description
User Func @*	Choose the function to perform in the function block.
User Input @-A	Communication address of the function's first input parameter.
User Input @-B	Communication address of the function's second input parameter.
User Input @-C	Communication address of the function's third input parameter.
User Output @	Output value (Read Only) after performing the function block.

* @ is the step number (1-18).

User Function Operation Condition

Number	Type	Description
0	NOP	No Operation.

Number	Type	Description
1	ADD	Addition operation, $(A + B) + C$ If the C parameter is 0x0000, it will be recognized as 0.
2	SUB	Subtraction operation, $(A - B) - C$ If the C parameter is 0x0000, it will be recognized as 0.
3	ADDSUB	Addition and subtraction compound operation, $(A + B) - C$ If the C parameter is 0x0000, it will be recognized as 0.
4	MIN	Output the smallest value of the input values, $\text{MIN}(A, B, C)$. If the C parameter is 0x0000, operate only with A, B.
5	MAX	Output the largest value of the input values, $\text{MAX}(A, B, C)$. If the C parameter is 0x0000, operate only with A, B.
6	ABS	Output the absolute value of the A parameter, $ A $. This operation does not use the B, or C parameter.
7	NEGATE	Output the negative value of the A parameter, $-(A)$. This operation does not use the B, or C parameter.
8	REMAINDER	Remainder operation of A and B, $A \% B$ This operation does not use the C parameter.
9	MPYDIV	Multiplication, division compound operation, $(A \times B)/C$. If the C parameter is 0x0000, output the multiplication operation of $(A \times B)$.
10	COMPARE-GT (greater than)	Comparison operation: if $(A > B)$ the output is C; if $(A \leq B)$ the output is 0. If the condition is met, the output parameter is C. If the condition is not met, the output is 0(False). If the C parameter is 0x0000 and if the condition is met, the output is 1(True).
11	COMPARE-GTEQ (great than or equal to)	Comparison operation; if $(A \geq B)$ output is C; if $(A < B)$ the output is 0. If the condition is met, the output parameter is C. If the condition is not met, the output is 0(False). If the C parameter is 0x0000 and if the condition is met, the output is 1(True).
12	COMPARE-EQUAL	Comparison operation, if $(A == B)$ then the output is C. For all other values the output is 0. If the condition is met, the output parameter is C. if the condition is not met, the output is 0(False). If the C parameter is 0x0000 and if the condition is met, the output is 1(True).
13	COMPARE-NEQUAL	Comparison operation, if $(A != B)$ then the output is C. For all other values the output is 0. If the condition is met, the output parameter is C. If the condition is not met, the output is 0(False). If the C parameter is 0x0000 and if the condition is met, the output is 1(True).
14	TIMER	Adds 1 each time a user sequence completes a loop. A: Max Loop, B: Timer Run/Stop, C: Choose output mode. If input of B is 1, timer stops (output is 0). If input is 0, timer runs. If input of C is 1, output the current timer value. If input of C is 0, output 1 when timer value exceeds A(Max) value. If the C parameter is 0x0000, C will be recognized as 0. Timer overflow Initializes the timer value to 0.
15	LIMIT	Sets a limit for the A parameter.

Number	Type	Description
		If input to A is between B and C, output the input to A. If input to A is larger than B, output B. If input of A is smaller than C, output C. B parameter must be greater than or equal to the C parameter.
16	AND	Output the AND operation, (A and B) and C. If the C parameter is 0x0000, operate only with A, B.
17	OR	Output the OR operation, (A B) C. If the C parameter is 0x0000, operate only with A, B.
18	XOR	Output the XOR operation, (A ^ B) ^ C. If the C parameter is 0x0000, operate only with A, B.
19	AND/OR	Output the AND/OR operation, (A and B) C. If the C parameter is 0x0000, operate only with A, B.
20	SWITCH	Output a value after selecting one of two inputs, if (A) then B otherwise C. If the input at A is 1, the output will be B. If the input at A is 0, the output parameter will be C.
21	BITTEST	Test the B bit of the A parameter, BITTEST(A, B). If the B bit of the A input is 1, the output is 1. If it is 0, then the output is 0. The input value of B must be between 0-16. If the value is higher than 16, it will be recognized as 16. If input at B is 0, the output is always 0.
22	BITSET	Set the B bit of the A parameter, BITSET(A, B). Output the changed value after setting the B bit to input at A. The input value of B must be between 0-16. If the value is higher than 16, it will be recognized as 16. If the input at B is 0, the output is always 0. This operation does not use the C parameter.
23	BITCLEAR	Clear the B bit of the A parameter, BITCLEAR(A, B). Output the changed value after clearing the B bit to input at A. The input value of B must be between 0-16. If the value is higher than 16, it will be recognized as 16. If the input at B is 0, the output is always 0. This operation does not use the C parameter.
24	LOWPASSFILTER	Output the input at A as the B filter gains time constant, B x US-02 (US Loop Time). In the above formula, set the time when the output of A reaches 63.3% C stands for the filter operation. If it is 0, the operation is started.
25	PI_CONTROL	P, I gain = A, B parameter input, then output as C. Conditions for PI_PROCESS output: C = 0: Const PI, C = 1: PI_PROCESS-B >= PI_PROCESS-OUT >= 0, C = 2: PI_PROCESS-B >= PI_PROCESS-OUT >= -(PI_PROCESS-B), P gain = A/100, I gain = 1/(Bx Loop Time), If there is an error with PI settings, output -1.
26	PI_PROCESS	A is an input error, B is an output limit, C is the value of Const PI output. Range of C is 0-32,767.
27	UPCOUNT	Upcounts the pulses and then output the value- UPCOUNT(A, B, C). After receiving a trigger input (A), outputs are upcounted by C conditions. If

Number	Type	Description
		the B inputs is 1, do not operate and display 0. If the B inputs is 0, operate. If the C parameter is 0, upcount when the input at A changes from 0 to 1. If the C parameter is 1, upcount when the input at A is changed from 1 to 0. If the C parameter is 2, upcount whenever the input at A changes. Output range is: 0-32767
28	DOWNCOUNT	Downcounts the pulses and then output the value- DOWNCOUNT(A, B, C). After receiving a trigger input (A), outputs are downcounted by C conditions. If the B input is 1, do not operate and display the initial value of C. If the B input is 0, operate. Downcounts when the A parameter changes from 0 to 1.

Note

The PI process block (PI_PROCESS Block) must be used after the PI control block (PI_CONTROL Block) for proper PI control operation. PI control operation cannot be performed if there is another block between the two blocks, or if the blocks are placed in an incorrect order.

Caution

User sequence features work only with code version 1.00, IO S/W version 0.11, and keypad S/W version 1.07 or higher versions.

4.24 Fire Mode Operation

This function is used to allow the inverter to ignore minor faults during emergency situations, such as fire, and provides continuous operation to fire pumps.

When turned on, Fire mode forces the inverter to ignore all minor fault trips and repeat a Reset and Restart for major fault trips, regardless of the restart trial count limit. The retry delay time set at PR. 10 (Retry Delay) still applies while the inverter performs a Reset and Restart.

Fire Mode Parameter Settings

Group	Code	Name	LCD Display	Parameter Setting	Setting Range	Unit
Ad	80	Fire Mode selection	Fire Mode Sel	1 Fire Mode	0-2	-
	81	Fire Mode frequency	Fire Mode Freq	0-60	0-60	
	82	Fire Mode run direction	Fire Mode Dir	0-1	0-1	
	83	Fire Mode operation	Fire Mode	Not configurable	-	-

Group	Code	Name	LCD Display	Parameter Setting		Setting Range	Unit
		count	Cnt				
In	65–71	Px terminal configuration	Px Define (Px: P1– P7)	51	Fire Mode	0–54	-

The inverter runs in Fire mode when Ad. 80 (Fire Mode Sel) is set to '2 (Fire Mode)', and the multi-function terminal (In. 65-71) configured for Fire mode (51: Fire Mode) is turned on. The Fire mode count increases by 1 at Ad. 83 (Fire Mode Count) each time a Fire mode operation is run.

Caution

Fire mode operation may result in inverter malfunction. Note that Fire mode operation voids the product warranty – the inverter is covered by the product warranty only when the Fire mode count is '0.'

Fire Mode Function Setting Details

Code	Description	Details
Ad.81 Fire Mode frequency	Fire mode frequency reference	The frequency set at Ad. 81 (Fire mode frequency) is used for the inverter operation in Fire mode. The Fire mode frequency takes priority over the Jog frequency, Multi-step frequencies, and the keypad input frequency.
Dr.03 Acc Time / Dr.04 Dec Time	Fire mode Acc/Dec times	When Fire mode operation is turned on, the inverter accelerates for the time set at Dr.03 (Acc Time), and then decelerates based on the deceleration time set at Dr.04 (Dec Time). It stops when the Px terminal input is turned off (Fire mode operation is turned off).
PR.10 Retry Delay	Fault trip process	Some fault trips are ignored during Fire mode operation. The fault trip history is saved, but trip outputs are disabled even when they are configured at the multi-function output terminals.
		<table border="1"> <thead> <tr> <th>Fault trips that are ignored in Fire mode</th> </tr> </thead> <tbody> <tr> <td>BX, External Trip, Low Voltage Trip, Inverter Overheat, Inverter Overload, Overload, Electrical Thermal Trip, Input/Output Open Phase, Motor Overload, Fan Trip, No Motor Trips, and other minor fault trips.</td> </tr> </tbody> </table> <p>For the following fault trips, the inverter performs a Reset and Restart until the trip conditions are released. The retry delay time set at PR. 10 (Retry Delay) applies while the inverter performs a</p>
Fault trips that are ignored in Fire mode		
BX, External Trip, Low Voltage Trip, Inverter Overheat, Inverter Overload, Overload, Electrical Thermal Trip, Input/Output Open Phase, Motor Overload, Fan Trip, No Motor Trips, and other minor fault trips.		

Code	Description	Details
		<p>Reset and Restart.</p> <p>Fault trips that force a Reset Restart in Fire mode Over Voltage, Over Current1(OC1), Ground Fault Trip</p> <p>The inverter stops operating when the following fault trips occur:</p> <p>Fault trips that stop inverter operation in Fire mode H/W Diag, Over Current 2 (Arm-Short)</p>

5 Learning Advanced Features

This chapter describes the advanced features of the S100 inverter. Check the reference page in the table to see the detailed description for each of the advanced features.

Advanced Tasks	Description	Ref.
Auxiliary frequency operation	Use the main and auxiliary frequencies in the predefined formulas to create various operating conditions. Auxiliary frequency operation is ideal for Draw Operation* as this feature enables fine-tuning of operation speeds.	p.122
Jog operation	Jog operation is a kind of a manual operation. The inverter operates to a set of parameter settings predefined for Jog operation, while the Jog command button is pressed.	p.126
Up-down operation	Uses the upper and lower limit value switch output signals (i.e. signals from a flow meter) as Acc/Dec commands to motors.	p.129
3-wire operation	3-wire operation is used to latch an input signal. This configuration is used to operate the inverter by a push button.	p.130
Safety operation mode	This safety feature allows the inverter's operation only after a signal is input to the multi-function terminal designated for the safety operation mode. This feature is useful when extra care is needed in operating the inverter using the multi-purpose terminals.	p.131
Dwell operation	Use this feature for the lift-type loads such as elevators, when the torque needs to be maintained while the brakes are applied or released.	p.133
Slip compensation	This feature ensures that the motor rotates at a constant speed, by compensating for the motor slip as a load increases.	p.134
PID control	PID control provides constant automated control of flow, pressure, and temperature by adjusting the output frequency of the inverter.	p.136
Auto-tuning	Used to automatically measure the motor control parameters to optimize the inverter's control mode performance.	p.144
Sensorless vector control	An efficient mode to control magnetic flux and torque without special sensors. Efficiency is achieved through the high torque characteristics at low current when compared with the V/F control mode.	p.147
Energy buffering operation	Used to maintain the DC link voltage for as long as possible by controlling the inverter output frequency during power interruptions, thus to delay a low voltage fault trip.	p.154
Energy saving operation	Used to save energy by reducing the voltage supplied to motors during low-load and no-load conditions.	p.155
Speed search operation	Used to prevent fault trips when the inverter voltage is output while the motor is idling or free-running.	p.159
Auto restart operation	Auto restart configuration is used to automatically restart the inverter when a trip condition is released, after the inverter stops operating due to activation of protective devices (fault trips).	p.163

Advanced Tasks	Description	Ref.
Second motor operation	Used to switch equipment operation by connecting two motors to one inverter. Configure and operate the second motor using the terminal input defined for the second motor operation.	p.166
Commercial power source switch operation	Used to switch the power source to the motor from the inverter output to a commercial power source, or vice versa.	p.167
Cooling fan control	Used to control the cooling fan of the inverter.	p.168
Timer settings	Set the timer value and control the On/Off state of the multi-function output and relay.	p.177
Brake control	Used to control the On/Off operation of the load's electronic braking system.	p.178
Multi-function output On/Off control	Set standard values and turn On/Off the output relays or multi-function output terminals according to the analog input value.	p.179
Regeneration prevention for press operation.	Used during a press operation to avoid motor regeneration, by increasing the motor operation speed.	p.180

* Draw operation is an openloop tension control. This feature allows a constant tension to be applied to the material that is drawn by a motor-driven device, by fine-tuning the motor speed using operation frequencies that are proportional to a ratio of the main frequency reference.

5.1 Operating with Auxiliary References

Frequency references can be configured with various calculated conditions that use the main and auxiliary frequency references simultaneously. The main frequency reference is used as the operating frequency, while auxiliary references are used to modify and fine-tune the main reference.

Group	Code	Name	LCD Display	Parameter Setting		Setting Range	Unit
Operation	Frq	Frequency reference source	Freq Ref Src	0	Keypad-1	0-12	-
bA	01	Auxiliary frequency reference source	Aux Ref Src	1	V1	0-4	-
	02	Auxiliary frequency reference calculation type	Aux Calc Type	0	M+(G*A)	0-7	-
	03	Auxiliary frequency reference gain	Aux Ref Gain	0.0		-200.0-200.0	%
In	65-71	Px terminal configuration	Px Define	40	dis Aux Ref	0~54	-

The table above lists the available calculated conditions for the main and auxiliary frequency references. Refer to the table to see how the calculations apply to an example where the Frq code has been set to 0(Keypad-1), and the inverter is operating at a main reference frequency of 30.00Hz. Signals at -10 – +10V are received at terminal V1, with the reference gain set at 5%. In this example, the resulting frequency reference is fine-tuned within the range of 27.00-33.00Hz [Codes In.01-16 must be set to the default values, and In.06 (V1 Polarity), set to 1 (Bipolar)].

Auxiliary Reference Setting Details

Code	Description																		
bA.01 Aux Ref Src	Set the input type to be used for the auxiliary frequency reference.																		
	<table border="1"> <thead> <tr> <th>Configuration</th> <th>Description</th> </tr> </thead> <tbody> <tr> <td>0</td> <td>None Auxiliary frequency reference is disabled.</td> </tr> <tr> <td>1</td> <td>V1 Sets the V1 (voltage) terminal at the control terminal block as the source of auxiliary frequency reference.</td> </tr> <tr> <td>3</td> <td>V2 Sets the V2 (voltage) terminal at the control terminal block as the source of auxiliary frequency reference (SW2 must be set to “voltage”).</td> </tr> <tr> <td>4</td> <td>I2 Sets the I2 (current) terminal at the control terminal block as the source of auxiliary frequency reference (SW2 must be set to “current”).</td> </tr> <tr> <td>5</td> <td>Pulse Sets the T1 (pulse) terminal at the control terminal block as the source of auxiliary frequency reference.</td> </tr> </tbody> </table>	Configuration	Description	0	None Auxiliary frequency reference is disabled.	1	V1 Sets the V1 (voltage) terminal at the control terminal block as the source of auxiliary frequency reference.	3	V2 Sets the V2 (voltage) terminal at the control terminal block as the source of auxiliary frequency reference (SW2 must be set to “voltage”).	4	I2 Sets the I2 (current) terminal at the control terminal block as the source of auxiliary frequency reference (SW2 must be set to “current”).	5	Pulse Sets the T1 (pulse) terminal at the control terminal block as the source of auxiliary frequency reference.						
	Configuration	Description																	
	0	None Auxiliary frequency reference is disabled.																	
	1	V1 Sets the V1 (voltage) terminal at the control terminal block as the source of auxiliary frequency reference.																	
	3	V2 Sets the V2 (voltage) terminal at the control terminal block as the source of auxiliary frequency reference (SW2 must be set to “voltage”).																	
4	I2 Sets the I2 (current) terminal at the control terminal block as the source of auxiliary frequency reference (SW2 must be set to “current”).																		
5	Pulse Sets the T1 (pulse) terminal at the control terminal block as the source of auxiliary frequency reference.																		
bA.02 Aux Calc Type	Set the auxiliary reference gain with bA.03 (Aux Ref Gain) to configure the auxiliary reference and set the percentage to be reflected when calculating the main reference. Note that items 4–7 below may result in either plus (+) or minus (-) references (forward or reverse operation) even when unipolar analog inputs are used.																		
	<table border="1"> <thead> <tr> <th>Configuration</th> <th>Formula for frequency reference</th> </tr> </thead> <tbody> <tr> <td>0</td> <td>$M+(G*A)$ Main reference+(bA.03xbA.01xIn.01)</td> </tr> <tr> <td>1</td> <td>$M*(G*A)$ $x(bA.03xbA.01)$</td> </tr> <tr> <td>2</td> <td>$M/(G*A)$ Main reference/(bA.03xbA.01)</td> </tr> <tr> <td>3</td> <td>$M+\{M*(G*A)\}$ Main reference+{Main reference x(bA.03xbA.01)}</td> </tr> <tr> <td>4</td> <td>$M+G*2*(A-50)$ Main reference+bA.03x2x(bA.01-50)x In.01</td> </tr> <tr> <td>5</td> <td>$M*\{G*2*(A-50)\}$ Main reference x{bA.03x2x(bA.01-50)}</td> </tr> <tr> <td>6</td> <td>$M/\{G*2*(A-50)\}$ Main reference/{bA.03x2x(bA.01-50)}</td> </tr> <tr> <td>7</td> <td>$M+M*G*2*(A-50)$ Main reference+Main reference x bA.03x2x(bA.01-50)</td> </tr> </tbody> </table>	Configuration	Formula for frequency reference	0	$M+(G*A)$ Main reference+(bA.03xbA.01xIn.01)	1	$M*(G*A)$ $x(bA.03xbA.01)$	2	$M/(G*A)$ Main reference/(bA.03xbA.01)	3	$M+\{M*(G*A)\}$ Main reference+{Main reference x(bA.03xbA.01)}	4	$M+G*2*(A-50)$ Main reference+bA.03x2x(bA.01-50)x In.01	5	$M*\{G*2*(A-50)\}$ Main reference x{bA.03x2x(bA.01-50)}	6	$M/\{G*2*(A-50)\}$ Main reference/{bA.03x2x(bA.01-50)}	7	$M+M*G*2*(A-50)$ Main reference+Main reference x bA.03x2x(bA.01-50)
	Configuration	Formula for frequency reference																	
	0	$M+(G*A)$ Main reference+(bA.03xbA.01xIn.01)																	
	1	$M*(G*A)$ $x(bA.03xbA.01)$																	
	2	$M/(G*A)$ Main reference/(bA.03xbA.01)																	
	3	$M+\{M*(G*A)\}$ Main reference+{Main reference x(bA.03xbA.01)}																	
	4	$M+G*2*(A-50)$ Main reference+bA.03x2x(bA.01-50)x In.01																	
	5	$M*\{G*2*(A-50)\}$ Main reference x{bA.03x2x(bA.01-50)}																	
	6	$M/\{G*2*(A-50)\}$ Main reference/{bA.03x2x(bA.01-50)}																	
7	$M+M*G*2*(A-50)$ Main reference+Main reference x bA.03x2x(bA.01-50)																		
M: Main frequency reference (Hz or rpm)																			
G: Auxiliary reference gain (%)																			
A: Auxiliary frequency reference (Hz or rpm) or gain (%)																			

Code	Description
bA.03 Aux Ref Gain	Adjust the size of the input (bA.01 Aux Ref Src) configured for auxiliary frequency.
In.65–71 Px Define	Set one of the multi-function input terminals to 40(dis Aux Ref) and turn it on to disable the auxiliary frequency reference. The inverter will operate using the main frequency reference only.

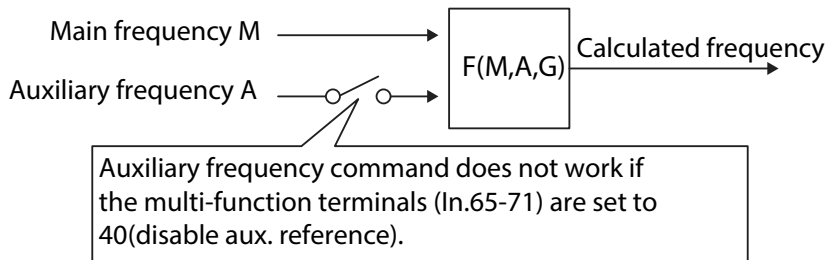

Auxiliary Reference Operation Ex #1

Keypad Frequency Setting is Main Frequency and V1 Analog Voltage is Auxiliary Frequency

- Main frequency: Keypad (operation frequency 30Hz)
- Maximum frequency setting (dr.20): 400Hz
- Auxiliary frequency setting (bA.01): V1 [Display by percentage(%) or auxiliary frequency (Hz) depending on the operation setting condition]
- Auxiliary reference gain setting (bA.03): 50%
- In.01–32: Factory default

Example: an input voltage of 6V is supplied to V1, and the frequency corresponding to 10V is 60Hz. The table below shows the auxiliary frequency A as 36Hz [= 60Hz X (6V/10V)] or 60% [= 100% X (6V/10V)].

Setting*	Calculating final command frequency**
0	$M[\text{Hz}] + (G[\%] * A[\text{Hz}])$ 30Hz(M) + (50%(G) x 36Hz(A)) = 48Hz
1	$M[\text{Hz}] * (G[\%] * A[\%])$ 30Hz(M) x (50%(G) x 60%(A)) = 9Hz
2	$M[\text{Hz}] / (G[\%] * A[\%])$ 30Hz(M) / (50%(G) x 60%(A)) = 100Hz
3	$M[\text{Hz}] + \{M[\text{Hz}] * (G[\%] * A[\%])\}$ 30Hz(M) + {30[Hz] x (50%(G) x 60%(A))} = 39Hz
4	$M[\text{Hz}] + G[\%] * 2 * (A[\%] - 50[\%]) [\text{Hz}]$ 30Hz(M) + 50%(G) x 2 x (60%(A) - 50%) x 60Hz = 36Hz
5	$M[\text{Hz}] * \{G[\%] * 2 * (A[\%] - 50[\%])\}$ 30Hz(M) x {50%(G) x 2 x (60%(A) - 50%)} = 3Hz
6	$M[\text{Hz}] / \{G[\%] * 2 * (A[\%] - 50[\%])\}$ 30Hz(M) / {50%(G) x 2 x (60% - 50%)} = 300Hz
7	$M[\text{Hz}] + M[\text{Hz}] * G[\%] * 2 * (A[\%] - 50[\%])$ 30Hz(M) + 30Hz(M) x 50%(G) x 2 x (60%(A) - 50%) = 33Hz

*M: main frequency reference (Hz or rpm)/G: auxiliary reference gain (%)/A: auxiliary frequency reference (Hz or rpm) or gain (%).

**If the frequency setting is changed to rpm, it is converted to rpm instead of Hz.

Auxiliary Reference Operation Ex #2

Keypad Frequency Setting is Main Frequency and I2 Analog Voltage is Auxiliary Frequency

- Main frequency: Keypad (Operation frequency 30Hz)
- Maximum frequency setting (dr.20): 400Hz
- Auxiliary frequency setting (bA.01): I2 [Display by percentage(%) or auxiliary frequency(Hz) depending on the operation setting condition]
- Auxiliary reference gain setting (bA.03): 50%
- In.01–32: Factory default

Example: an input current of 10.4mA is applied to I2, with the frequency corresponding to 20mA of 60Hz. The table below shows auxiliary frequency A as 24Hz(=60[Hz] X {(10.4[mA]-4[mA])/(20[mA] - 4[mA])}) or 40%(=100[%] X {(10.4[mA] - 4[mA])/(20[mA] - 4[mA])}).

Setting*		Calculating final command frequency**
0	$M[\text{Hz}] + (G[\%] * A[\text{Hz}])$	$30\text{Hz}(M) + (50\%(G) \times 24\text{Hz}(A)) = 42\text{Hz}$
1	$M[\text{Hz}] * (G[\%] * A[\%])$	$30\text{Hz}(M) \times (50\%(G) \times 40\%(A)) = 6\text{Hz}$
2	$M[\text{Hz}] / (G[\%] * A[\%])$	$30\text{Hz}(M) / (50\%(G) \times 40\%(A)) = 150\text{Hz}$
3	$M[\text{Hz}] + \{M[\text{Hz}] * (G[\%] * A[\%])\}$	$30\text{Hz}(M) + \{30[\text{Hz}] \times (50\%(G) \times 40\%(A))\} = 36\text{Hz}$
4	$M[\text{Hz}] + G[\%] * 2 * (A[\%] - 50[\%])[\text{Hz}]$	$30\text{Hz}(M) + 50\%(G) \times 2 \times (40\%(A) - 50\%) \times 60\text{Hz} = 24\text{Hz}$
5	$M[\text{Hz}] * \{G[\%] * 2 * (A[\%] - 50[\%])\}$	$30\text{Hz}(M) \times \{50\%(G) \times 2 \times (40\%(A) - 50\%)\} = -3\text{Hz(Reverse)}$
6	$M[\text{Hz}] / \{G[\%] * 2 * (A[\%] - 50[\%])\}$	$30\text{Hz}(M) / \{50\%(G) \times 2 \times (60\% - 40\%)\} = -300\text{Hz(Reverse)}$
7	$M[\text{Hz}] + M[\text{Hz}] * G[\%] * 2 * (A[\%] - 50[\%])$	$30\text{Hz}(M) + 30\text{Hz}(M) \times 50\%(G) \times 2 \times (40\%(A) - 50\%) = 27\text{Hz}$

* M: main frequency reference (Hz or rpm)/G: auxiliary reference gain (%)/A: auxiliary frequency reference Hz or rpm) or gain (%).

**If the frequency setting is changed to rpm, it is converted to rpm instead of Hz.

Auxiliary Reference Operation Ex #3

V1 is Main Frequency and I2 is Auxiliary Frequency

- Main frequency: V1 (frequency command setting to 5V and is set to 30Hz)
- Maximum frequency setting (dr.20): 400Hz
- Auxiliary frequency (bA.01): I2[Display by percentage (%) or auxiliary frequency (Hz) depending on the operation setting condition]
- Auxiliary reference gain (bA.03): 50%
- In.01–32: Factory default

Example: an input current of 10.4mA is applied to I2, with the frequency corresponding to 20mA of 60Hz. The table below shows auxiliary frequency A as 24Hz(=60[Hz]x{(10.4[mA]-4[mA])/(20[mA]-

4[mA]}} or $40\% (= 100\% \times \{(10.4[mA] - 4[mA]) / (20[mA] - 4[mA])\}$.

Setting*	Calculating final command frequency**
0	$M[\text{Hz}] + (G[\%] \times A[\text{Hz}])$ 30Hz(M)+(50%(G)x24Hz(A))=42Hz
1	$M[\text{Hz}] \times (G[\%] \times A[\%])$ 30Hz(M)x(50%(G)x40%(A))=6Hz
2	$M[\text{Hz}] / (G[\%] \times A[\%])$ 30Hz(M)/(50%(G)x40%(A))=150Hz
3	$M[\text{Hz}] + \{M[\text{Hz}] \times (G[\%] \times A[\%])\}$ 30Hz(M)+{30[Hz]x(50%(G)x40%(A))}=36Hz
4	$M[\text{Hz}] + G[\%] \times 2 \times (A[\%] - 50\%)[\text{Hz}]$ 30Hz(M)+50%(G)x2x(40%(A)-50%)x60Hz=24Hz
5	$M[\text{Hz}] \times \{G[\%] \times 2 \times (A[\%] - 50\%)\}$ 30Hz(M)x{50%(G)x2x(40%(A)-50%)}=3Hz(Reverse)
6	$M[\text{Hz}] / \{G[\%] \times 2 \times (A[\%] - 50\%)\}$ 30Hz(M)/{50%(G)x2x(60%-40%)}=300Hz(Reverse)
7	$M[\text{Hz}] + M[\text{Hz}] \times G[\%] \times 2 \times (A[\%] - 50\%)$ 30Hz(M)+30Hz(M)x50%(G)x2x(40%(A)-50%)=27Hz

* M: main frequency reference (Hz or rpm)/G: auxiliary reference gain (%)/A: auxiliary frequency reference (Hz or rpm) or gain (%).

**If the frequency setting is changed to rpm, it is converted to rpm instead of Hz.

Note

When the maximum frequency value is high, output frequency deviation may result due to analog input variation and deviations in the calculations.

5.2 Jog operation

The jog operation allows for a temporary control of the inverter. You can enter a jog operation command using the multi-function terminals or by using the [ESC] key on the keypad.

The jog operation is the second highest priority operation, after the dwell operation. If a jog operation is requested while operating the multi-step, up-down, or 3-wire operation modes, the jog operation overrides all other operation modes.

5.2.1 Jog Operation 1-Forward Jog by Multi-function Terminal

The jog operation is available in either forward or reverse direction, using the keypad or multi-function terminal inputs. The table below lists parameter setting for a forward jog operation using the multi-function terminal inputs.

Group	Code	Name	LCD Display	Parameter Setting	Setting Range	Unit
dr	11	Jog frequency	JOG Frequency	10.00	0.50-Maximum frequency	Hz

Group	Code	Name	LCD Display	Parameter Setting		Setting Range	Unit
	12	Jog operation acceleration time	JOG Acc Time	20.00		0.00-600.00	sec
	13	Jog operation deceleration time	JOG Dec Time	30.00		0.00-600.00	sec
In	65-71	Px terminal configuration	Px Define(Px: P1-P7)	6	JOG	-	-

Forward Jog Description Details

Code	Description
In.65-71 Px Define	Select the jog frequency from P1- P7 and then select 6. Jog from In.65-71. <p>[Terminal settings for jog operation]</p>
dr.11 JOG Frequency	Set the operation frequency.
dr.12 JOG Acc Time	Set the acceleration speed.
dr.13 JOG Dec Time	Set the deceleration speed.

If a signal is entered at the jog terminal while an FX operation command is on, the operation frequency changes to the jog frequency and the jog operation begins.

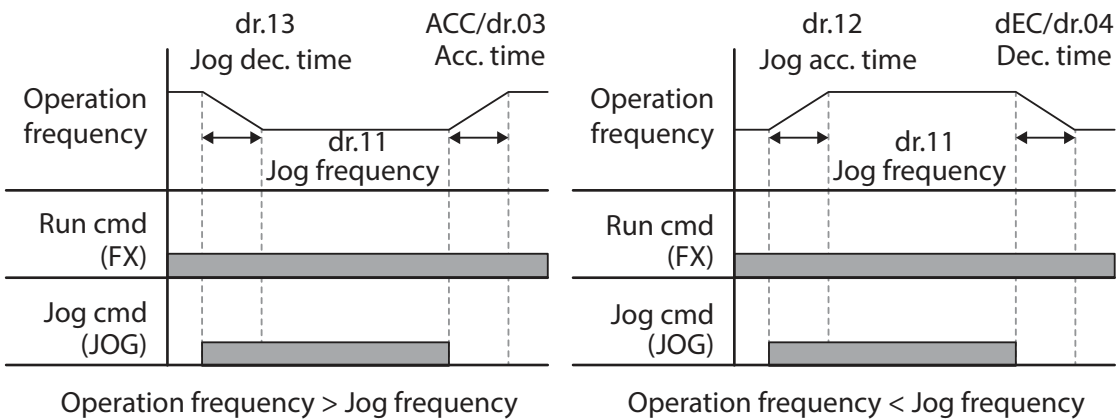

5.2.2 Jog Operation 2-Fwd/Rev Jog by Multi-function Terminal

For jog operation 1, an operation command must be entered to start operation, but while using jog operation 2, a terminal that is set for a forward or reverse jog also starts an operation. The priorities for frequency, Acc/Dec time and terminal block input during operation in relation to other operating modes (Dwell, 3-wire, up/down, etc.) are identical to jog operation 1. If a different operation command is entered during a jog operation, it is ignored and the operation maintains the jog frequency.

Group	Code	Name	LCD Display	Parameter setting	Setting Range	Unit	
dr	11	Jog frequency	JOG Frequency	10.00	0.50-Maximum frequency	Hz	
	12	Jog operation acceleration time	JOG AccTime	20.00	0.00-600.00	sec	
	13	Operation deceleration time	JOG DecTime	30.00	0.00-600.00	sec	
In	65-71	Px terminal configuration	Px Define(Px: P1-P7)	46	FWD JOG	-	-
				47	REV JOG		

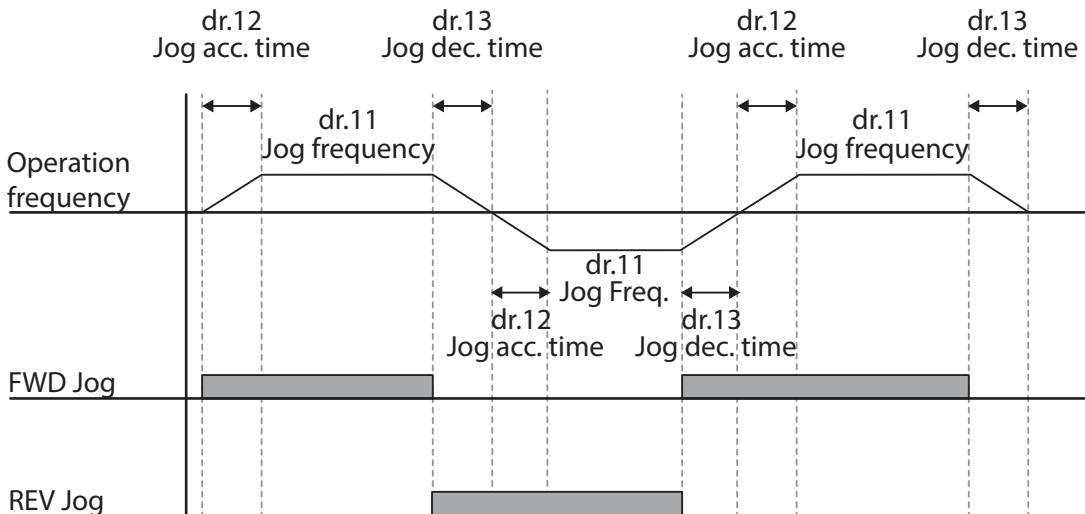

5.2.3 Jog Operation by Keypad

Group	Code	Name	LCD Display	Parameter Setting	Setting Range	Unit
Dr	90	[ESC] key functions	-	1	JOG Key	-
	06	Command source	Cmd Source*	0	Keypad	-

* Displayed under DRV-06 on the LCD keypad.

Set dr.90 to 1(JOG Key) and set the drv code in the Operation group to 0(Keypad). When the [ESC] key is pressed, the SET display light flashes and the jog operation is ready to start. Pressing the [RUN] key starts the operation and the inverter accelerates or decelerates to the designated jog frequency. Releasing the [RUN] key stops the jog operation. Set the Acc/Dec time for the jog operation frequency at dr.12 and dr.13.

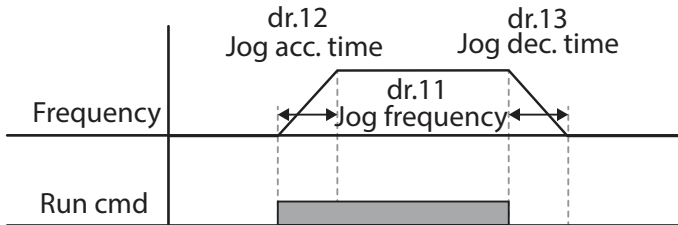

5.3 Up-down Operation

The Acc/Dec time can be controlled through input at the multi-function terminal block. Similar to a flowmeter, the up-down operation can be applied easily to a system that uses the upper-lower limit switch signals for Acc/Dec commands.

Group	Code	Name	LCD Display	Parameter Setting		Setting Range	Unit
Ad	65	Up-down operation frequency save	U/D Save Mode	1	Yes	0-1	-
In	65-71	Px terminal configuration	Px Define(Px: P1-P7)	17	Up	-	-
				18	Down		
				20	U/D Clear		

Up-down Operation Setting Details

Code	Description
In.65-71 Px Define	<p>Select two terminals for up-down operation and set them to 17 (Up) and 18 (Down), respectively. With the operation command input, acceleration begins when the Up terminal signal is on. Acceleration stops and constant speed operation begins when the signal is off.</p> <p>During operation, deceleration begins when the Down signal is on. Deceleration stops and constant speed operation begins when both Up and Down signals are entered at the same time.</p>

Code	Description
Ad.65 U/D Save Mode	<p>During a constant speed operation, the operating frequency is saved automatically in the following conditions: the operation command (Fx or Rx) is off, a fault trip occurs, or the power is off.</p> <p>When the operation command is turned on again, or when the inverter regains the power source or resumes to a normal operation from a fault trip, it resumes operation at the saved frequency. To delete the saved frequency, use the multi-function terminal block. Set one of the multi-function terminals to 20 (U/D Clear) and apply signals to it during constant speed operation. The saved frequency and the up-down operation configuration will be deleted.</p>

5.4 3-Wire Operation

The 3-wire operation latches the signal input (the signal stays on after the button is released), and is used when operating the inverter with a push button.

Group	Code	Name	LCD Display	Parameter Setting	Setting Range	Unit
Operation	drv	Command source	Cmd Source*	1	Fx/Rx - 1	-
In	65-71	Px terminal configuration	Px Define(Px: P1-P5)	14	3-Wire	-

* Displayed under DRV-06 in an LCD keypad.

To enable the 3-wire operation, the following circuit sequence is necessary. The minimum input time (t) for 3-wire operation is 1ms, and the operation stops when both forward and reverse operation commands are entered at the same time.

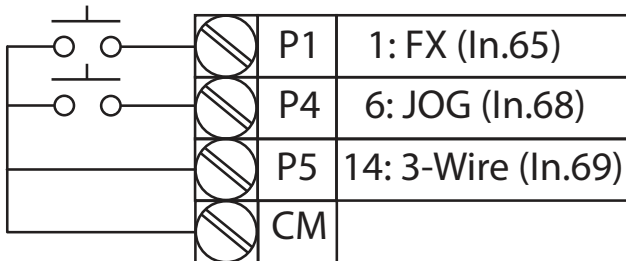

[Terminal connections for 3-wire operation]

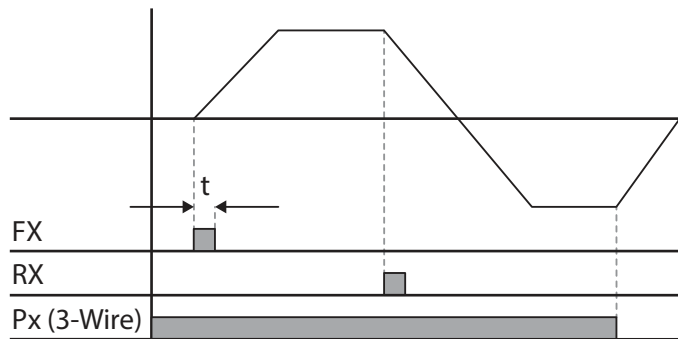

[3-wire operation]

5.5 Safe Operation Mode

When the multi-function terminals are configured to operate in safe mode, operation commands can be entered in the Safe operation mode only. Safe operation mode is used to safely and carefully control the inverter through the multi-function terminals.

Group	Code	Name	LCD Display	Parameter Setting	Setting Range	Unit
Ad	70	Safe operation selection	Run En Mode	1 DI Dependent	-	-
	71	Safe operation stop mode	Run Dis Stop	0 Free-Run	0-2	-
	72	Safe operation deceleration time	Q-Stop Time	5.0	0.0-600.0	sec
In	65-69	Px terminal configuration	Px Define(Px: P1-P5)	13 RUN Enable	-	-

Safe Operation Mode Setting Details

Code	Description		
In.65-69 Px Define	From the multi-function terminals, select a terminal to operate in safe operation mode and set it to 13 (RUN Enable).		
Ad.70 Run En Mode	Setting		
	0	Always Enable	Enables safe operation mode.
	1	DI Dependent	Recognizes the operation command from a multi-function input terminal.
Ad.71 Run Dis Stop	Set the operation of the inverter when the multi-function input terminal in safe operation mode is off.		
	Setting		Function
	1	Free-Run	Blocks the inverter output when the multi-function terminal is off.
	2	Q-Stop	The deceleration time (Q-Stop Time) used in safe operation mode. It stops after deceleration and then the operation can resume only when the operation command is entered again. The operation will not begin if only the multi-function terminal is on.
	3	Q-Stop Resume	The inverter decelerates to the deceleration time (Q-Stop Time) in safe operation mode. It stops after deceleration. Then if the multi-function terminal is on, the operation resumes as soon as the operation command is entered again.
Ad.72 Q-Stop Time	Sets the deceleration time when Ad.71 (Run Dis Stop) is set to 1 (Q-Stop) or 2 (Q-Stop Resume).		

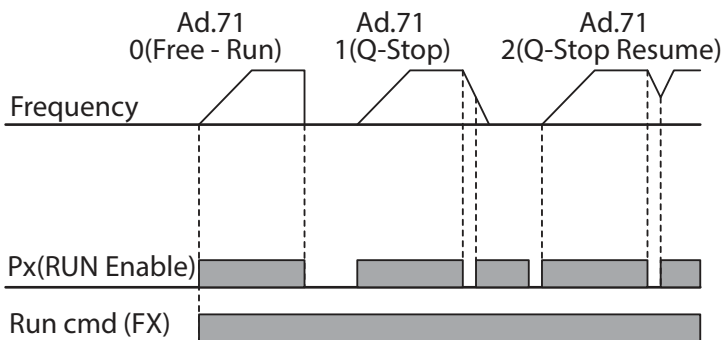

5.6 Dwell Operation

The dwell operation is used to maintain torque during the application and release of the brakes on lift-type loads. Inverter dwell operation is based on the Acc/Dec dwell frequency and the dwell time set by the user. The following points also affect dwell operation:

- **Acceleration Dwell Operation:** When an operation command runs, acceleration continues until the acceleration dwell frequency and constant speed is reached within the acceleration dwell operation time (Acc Dwell Time). After the Acc Dwell Time has passed, acceleration is carried out based on the acceleration time and the operation speed that was originally set.
- **Deceleration Dwell Operation:** When a stop command is run, deceleration continues until the deceleration dwell frequency and constant speed is reached within the deceleration dwell operation time (Dec Dwell Freq). After the set time has passed, deceleration is carried out based on the deceleration time that was originally set, then the operation stops.

When dr.09 (Control Mode) is set to 0 (V/F), the inverter can be used for operations with dwell frequency before opening the mechanical brake of lift-type loads, such as an elevator.

Group	Code	Name	LCD Display	Parameter Setting	Setting Range	Unit
Ad	20	Dwell frequency during acceleration	Acc Dwell Freq	5.00	Start frequency – Maximum frequency	Hz
	21	Operation time during acceleration	Acc Dwell Time	0.0	0.0–10.0	s
	22	Dwell frequency during deceleration	Dec Dwell Freq	5.00	Start frequency – Maximum frequency	Hz
	23	Operation time during deceleration	Dec Dwell Time	0.0	0.0-60.0	s

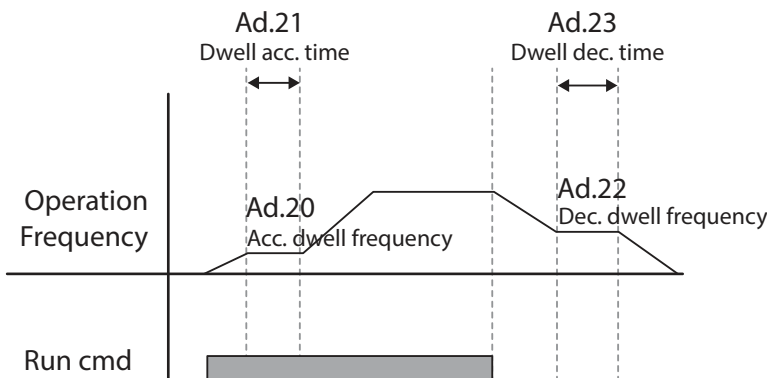

Note

Dwell operation does not work when:

- Dwell operation time is set to 0 sec or dwell frequency is set to 0 Hz.
- Re-acceleration is attempted from stop or during deceleration, as only the first acceleration dwell operation command is valid.

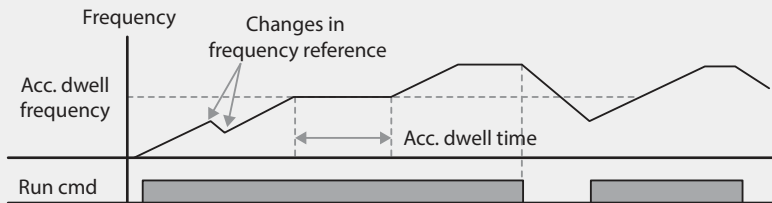

[Acceleration dwell operation]

Although deceleration dwell operation is carried out whenever stop commands are entered and the deceleration dwell frequency is passed through, it does not work during a deceleration by simple frequency change (which is not a deceleration due to a stop operation), or during external brake control applications.

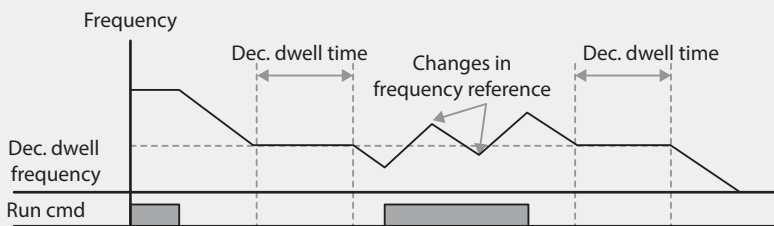

[Deceleration dwell operation]

⚠ Caution

When a dwell operation is carried out for a lift - type load before its mechanical brake is released, motors can be damaged or their lifecycle reduced due to overflow current in the motor.

5.7 Slip Compensation Operation

Slip refers to the variation between the setting frequency (synchronous speed) and motor rotation speed. As the load increases there can be variations between the setting frequency and motor rotation speed. Slip compensation is used for loads that require compensation of these speed variations.

Group	Code	Name	LCD Display	Parameter Setting	Setting Range	Unit
dr	09	Control mode	Control Mode	2 Slip Compen	-	-
	14	Motor capacity	Motor Capacity	2 0.75 kW (0.75kW based)	0-15	-
bA	11	Number of motor poles	Pole Number	4	2-48	-
	12	Rated slip speed	Rated Slip	90 (0.75kW based)	0-3000	rpm
	13	Rated motor current	Rated Curr	3.6 (0.75kW based)	1.0-1000.0	A
	14	Motor no-load current	Noload Curr	1.6 (0.75kW based)	0.5-1000.0	A
	16	Motor efficiency	Efficiency	72 (0.75kW based)	70-100	%
	17	Load inertia rate	Inertia Rate	0 (0.75kW based)	0-8	-

Slip Compensation Operation Setting Details

Code	Description								
dr.09 Control Mode	Set dr.09 to 2 (Slip Compen) to carry out the slip compensation operation.								
dr.14 Motor Capacity	Set the capacity of the motor connected to the inverter.								
bA.11 Pole Number	Enter the number of poles from the motor rating plate.								
bA.12 Rated Slip	Enter the number of rated rotations from the motor rating plate.								
bA.13 Rated Curr	Enter the rated current from the motor rating plate.								
bA.14 Noload Curr	Enter the measured current when the load on the motor axis is removed and when the motor is operated at the rated frequency. If no-load current is difficult to measure, enter a current equivalent to 30-50% of the rated motor current.								
bA.16 Efficiency	Enter the efficiency from the motor rating place.								
bA.17 Inertia Rate	<p>Select load inertia based on motor inertia.</p> <table border="1" style="width: 100%;"> <thead> <tr> <th>Setting</th> <th>Function</th> </tr> </thead> <tbody> <tr> <td>0</td> <td>Less than 10 times motor inertia</td> </tr> <tr> <td>1</td> <td>10 times motor inertia</td> </tr> <tr> <td>2-8</td> <td>More than 10 times motor inertia</td> </tr> </tbody> </table> $f_s = f_r - \frac{Rpm \times P}{120}$ <p> f_s=Rated slip frequency f_r=Rated frequency rpm=Number of the rated motor rotations P=Number of motor poles </p>	Setting	Function	0	Less than 10 times motor inertia	1	10 times motor inertia	2-8	More than 10 times motor inertia
Setting	Function								
0	Less than 10 times motor inertia								
1	10 times motor inertia								
2-8	More than 10 times motor inertia								

Motor Rotation

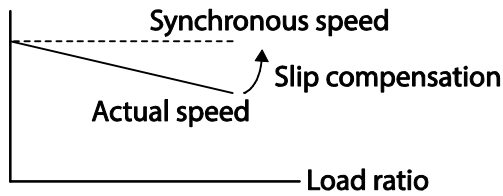

5.8 PID Control

Pid control is one of the most common auto-control methods. It uses a combination of proportional, integral, and differential (PID) control that provides more effective control for automated systems. The functions of PID control that can be applied to the inverter operation are as follows:

Purpose	Function
Speed control	Controls speed by using feedback about the existing speed level of the equipment or machinery to be controlled. Control maintains consistent speed or operates at the target speed.
Pressure control	Controls pressure by using feedback about the existing pressure level of the equipment or machinery to be controlled. Control maintains consistent pressure or operates at the target pressure.
Flow control	Controls flow by using feedback about the amount of existing flow in the equipment or machinery to be controlled. Control maintains consistent flow or operates at a target flow.
Temperature control	Controls temperature by using feedback about the existing temperature level of the equipment or machinery to be controlled. Control maintains a consistent temperature or operates at a target temperature.

5.8.1 PID Basic Operation

PID operates by controlling the output frequency of the inverter, through automated system process control to maintain speed, pressure, flow, temperature and tension.

Group	Code	Name	LCD Display	Parameter Setting	Setting Range	Unit
AP	01	Application function selection	App Mode	2 Proc PID	0-2	-
	16	PID output monitor	PID Output	-	-	-
	17	PID reference monitor	PID Ref Value	-	-	-
	18	PID feedback monitor	PID Fdb Value	-	-	-

Group	Code	Name	LCD Display	Parameter Setting		Setting Range	Unit
	19	PID reference setting	PID Ref Set	50.00		-100.00-100.00	%
	20	PID reference source	PID Ref Source	0	Keypad	0-11	-
	21	PID feedback source	PID F/B Source	0	V1	0-10	-
	22	PID controller proportional gain	PID P-Gain	50.0		0.0-1000.0	%
	23	PID controller integral time	PID I-Time	10.0		0.0-200.0	sec
	24	PID controller differential time	PID D-Time	0		0-1000	msec
	25	PID controller feed-forward compensation gain	PID F-Gain	0.0		0-1000	%
	26	Proportional gain scale	P Gain Scale	100.0		0.0-100.0	%
	27	PID output filter	PID Out LPF	0		0-10000	ms
	29	PID maximum frequency	PID Limit Hi	60.00		-300.00-300.00	Hz
	30	PID minimum frequency	PID Limit Lo	0.5		-300.00-300.00	Hz
	31	PID output reverse	PID Out Inv	0	No	0-1	-
	32	PID output scale	PID Out Scale	100.0		0.1-1000.0	%
	34	PID controller motion frequency	Pre-PID Freq	0.00		0-Maximum frequency	Hz
	35	PID controller motion level	Pre-PID Exit	0.0		0.0-100.0	%
	36	PID controller motion delay time	Pre-PID Delay	600		0-9999	sec
	37	PID sleep mode delay time	PID Sleep DT	60.0		0-999.9	sec
	38	PID sleep mode frequency	PID Sleep Freq	0.00		0-Maximum frequency	Hz
	39	PID wake-up level	PID WakeUp Lev	35		0-100	%
	40	PID wake-up mode selection	PID WakeUp Mod	0	Below Level	0-2	-
	42	PID controller unit selection	PID Unit Sel	0	%	0-12	-
	43	PID unit gain	PID Unit Gain	100.0		0-300	%
	44	PID unit scale	PID Unit Scale	2	x 1	0-4	-
	45	PID 2 nd proportional gain	PID P2-Gain	100.00		0-1000	%
In	65-71	Px terminal configuration	Px Define (Px: P1-P7)	22	I-Term Clear	-	-
				23	PID Openloop		
				24	P Gain2		

PID Basic Operation Setting Details

Code	Description																
AP.01 App Mode	Set the code to 2 (Proc PID) to select functions for the process PID.																
AP.16 PID Output	Displays the existing output value of the PID controller. The unit, gain, and scale that were set at AP. 42-44 are applied on the display.																
AP.17 PID Ref Value	Displays the existing reference value set for the PID controller. The unit, gain, and scale that were set at AP. 42-44 are applied on the display.																
AP.18 PID Fdb Value	Displays the input value of the PID controller that is included in the latest feedback. The unit, gain, and scale that were set at AP. 42-44 are applied on the display.																
AP.19 PID Ref Set	When AP.20 (PID control reference source) is set to 0 (Keypad), the reference value can be entered. If the reference source is set to any other value, the setting values for AP.19 are void.																
AP.20 PID Ref Source	<p>Selects the reference input for the PID control. If the V1 terminal is set to PID feedback source (PID F/B Source), the V1 terminal cannot be set to the PID reference source (PID Ref Source). To set V1 as a reference source, change the feedback source.</p> <table border="1"> <thead> <tr> <th>Setting</th> <th>Function</th> </tr> </thead> <tbody> <tr> <td>0</td> <td>Keypad</td> </tr> <tr> <td>1</td> <td>V1</td> </tr> <tr> <td>3</td> <td>V2</td> </tr> <tr> <td>4</td> <td>I2</td> </tr> <tr> <td>5</td> <td>Int. 485</td> </tr> <tr> <td>7</td> <td>FieldBus</td> </tr> <tr> <td>11</td> <td>Pulse</td> </tr> </tbody> </table> <p>When using the keypad, the PID reference setting can be displayed at AP.17. When using the LDC keypad, the PID reference setting can be monitored from the config mode (CNF) -06-08, set to 17 (PID Ref Value).</p>	Setting	Function	0	Keypad	1	V1	3	V2	4	I2	5	Int. 485	7	FieldBus	11	Pulse
Setting	Function																
0	Keypad																
1	V1																
3	V2																
4	I2																
5	Int. 485																
7	FieldBus																
11	Pulse																
AP.21 PID F/B Source	Selects feedback input for PID control. Items can be selected as reference input, except the keypad input (Keypad-1 and Keypad-2). Feedback cannot be set to an input item that is identical to the item selected as the reference. For example, when Ap.20 (Ref Source) is set to 1 (V1), for AP. 21 (PID F/B Source), an input other than the V1 terminal must be selected. When using the LCD keypad, the volume of feedback can be monitored using a code from the config mode (CNF) -06-08, by setting it to 18 (PID Fbk Value).																
AP.22 PID P-Gain, AP.26 P Gain Scale	Sets the output ratio for differences (errors) between reference and feedback. If the Pgain is set to 50%, then 50% of the error is output. The setting range for Pgain is 0.0-1,000%. For ratios below 0.1%, use AP.26 (P Gain Scale).																

Code	Description																																
AP.23 PID I-Time	Sets the time to output accumulated errors. When the error is 100%, the time taken for 100% output is set. When the integral time (PID I-Time) is set to 1 second, 100% output occurs after 1 second of the error remaining at 100%. Differences in a normal state can be reduced by PID I Time. When the multi-function terminal block is set to 21(I-Term Clear) and is turned on, all of the accumulated errors are deleted.																																
AP.24 PID D-Time	Sets the output volume for the rate of change in errors. If the differential time (PID D-Time) is set to 1ms and the rate of change in errors per sec is 100%, output occurs at 1% per 10ms.																																
AP.25 PID F-Gain	Sets the ratio that adds the target to the PID output. Adjusting this value leads to a faster response.																																
AP.27 PID Out LPF	Used when the output of the PID controller changes too fast or the entire system is unstable, due to severe oscillation. In general, a lower value (default value=0) is used to speed up response time, but in some cases a higher value increases stability. The higher the value, the more stable the PID controller output is, but the slower the response time.																																
AP.29 PID Limit Hi, AP.30 PID Limit Lo	Limits the output of the controller.																																
AP.32 PID Out Scale	Adjusts the volume of the controller output.																																
AP.42 PID Unit Sel	Sets the unit of the control variable (available only on the LCD keypad). <table border="1" data-bbox="381 973 1236 1466"> <thead> <tr> <th>Setting</th> <th>Function</th> </tr> </thead> <tbody> <tr> <td>0</td> <td>%</td> <td rowspan="5">Displays a percentage without a physical quantity given.</td> </tr> <tr> <td>1</td> <td>Bar</td> </tr> <tr> <td>2</td> <td>mBar</td> </tr> <tr> <td>3</td> <td>Pa</td> </tr> <tr> <td>4</td> <td>kPa</td> </tr> <tr> <td>5</td> <td>Hz</td> <td rowspan="2">Displays the inverter output frequency or the motor rotation speed.</td> </tr> <tr> <td>6</td> <td>rpm</td> </tr> <tr> <td>7</td> <td>V</td> <td rowspan="4">Displays in voltage/current/power/horsepower.</td> </tr> <tr> <td>8</td> <td>I</td> </tr> <tr> <td>9</td> <td>kW</td> </tr> <tr> <td>10</td> <td>HP</td> </tr> <tr> <td>11</td> <td>°C</td> <td rowspan="2">Displays in Celsius or Fahrenheit.</td> </tr> <tr> <td>12</td> <td>°F</td> </tr> </tbody> </table>	Setting	Function	0	%	Displays a percentage without a physical quantity given.	1	Bar	2	mBar	3	Pa	4	kPa	5	Hz	Displays the inverter output frequency or the motor rotation speed.	6	rpm	7	V	Displays in voltage/current/power/horsepower.	8	I	9	kW	10	HP	11	°C	Displays in Celsius or Fahrenheit.	12	°F
Setting	Function																																
0	%	Displays a percentage without a physical quantity given.																															
1	Bar																																
2	mBar																																
3	Pa																																
4	kPa																																
5	Hz	Displays the inverter output frequency or the motor rotation speed.																															
6	rpm																																
7	V	Displays in voltage/current/power/horsepower.																															
8	I																																
9	kW																																
10	HP																																
11	°C	Displays in Celsius or Fahrenheit.																															
12	°F																																
AP.43 PID Unit Gain, AP.44 PID Unit Scale	Adjusts the size to fit the unit selected at AP.41 PID Unit Sel.																																
AP.45 PID P2-Gain	The PID controller's gain can be adjusted using the multi-function terminal. When a terminal is selected from In.65-71 and set to 24 (P Gain2), and if the selected terminal is entered, the gain set in AP.22 and AP.23 can be switched to the gain set in AP.45.																																

Note

When the PID switch operation (switching from PID operation to general operation) enters the multi-function input, [%] values are converted to [Hz] values. The normal PID output, PID OUT, is unipolar, and is limited by AP.29 (PID Limit Hi) and AP.30 (PID Limit Lo). A calculation of 100.0% is based on the dr.20 (Max Freq) parameter setting.

[PID control block diagram]

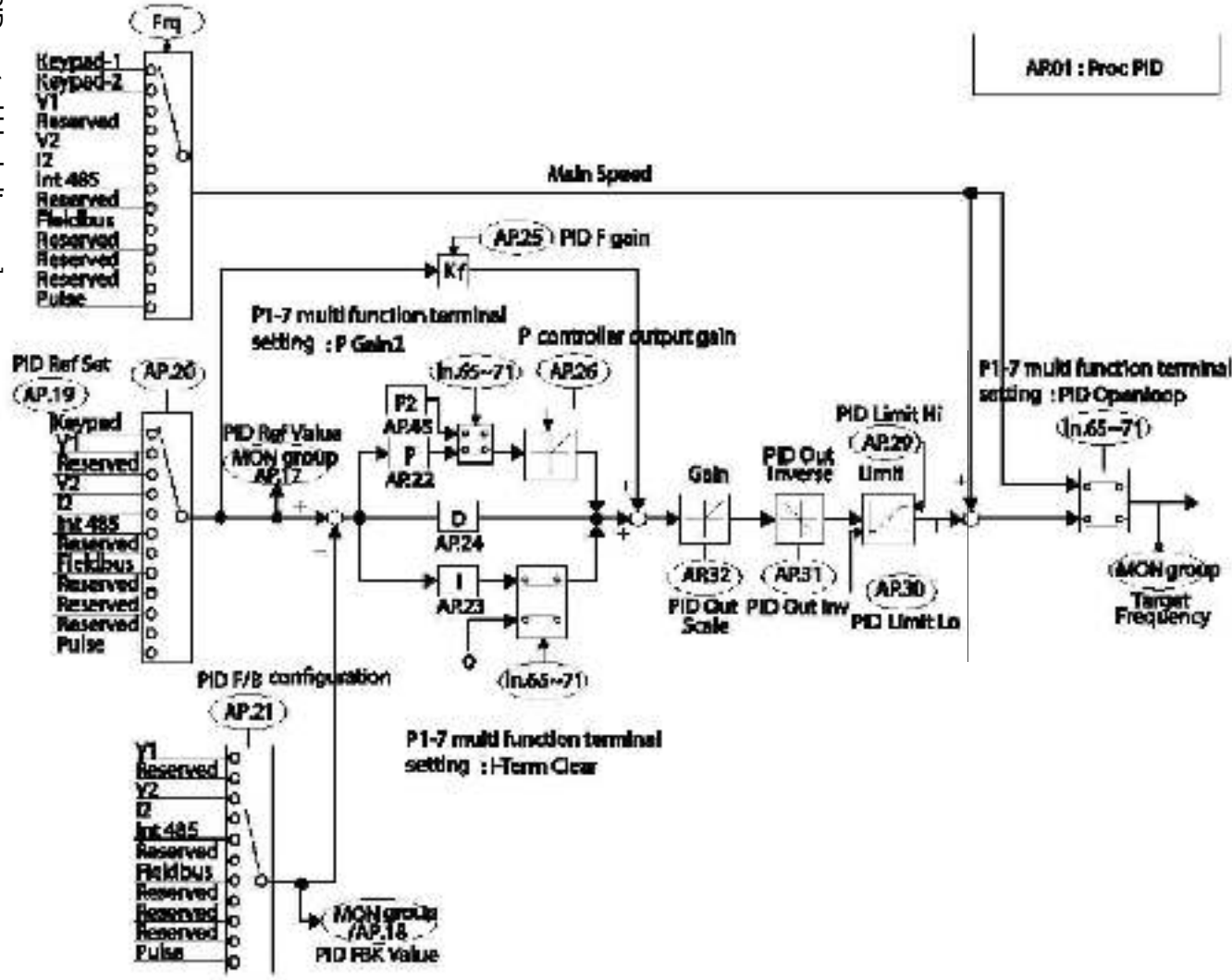

AR01 : Proc PID

5.8.2 Pre-PID Operation

When an operation command is entered that does not include PID control, general acceleration occurs until the set frequency is reached. When the controlled variables increase to a particular point, the PID operation begins.

Pre-PID Operation Setting Details

Code	Description
AP.34 Pre-PID Freq	When general acceleration is required, the frequency up to general acceleration is entered. If Pre-PID Freq is set to 30Hz, the general operation continues until the control variable (PID feedback variable) set at AP. 35 is exceeded.
AP.35 Pre-PID Exit, AP.36 Pre-PID Delay	When the feedback variable of the PID controller is higher than the value set at AP. 35, the PID control operation begins. However, when a value is set for AP.36 (Pre-PID Delay) and a feedback variable less than the value set at AP.35 is maintained for a set amount of time, the “pre-PID Fail” fault trip will occur and the output will be blocked.

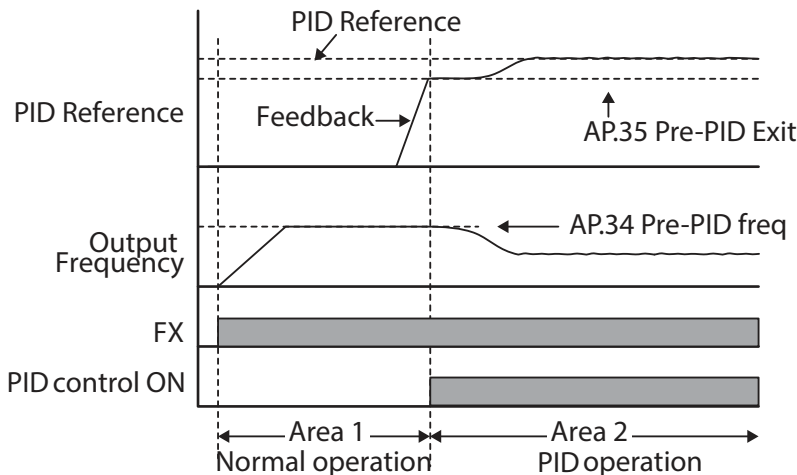

5.8.3 PID Operation Sleep Mode

If the operation continues at a frequency lower than the set condition for PID operation, the PID operation sleep mode starts. When PID operation sleep mode starts, the operation will stop until the feedback exceeds the parameter value set at AP.39 (PID WakeUp Lev).

PID Operation Sleep Mode Setting Details

Code	Description
AP.37 PID Sleep DT, AP.38 PID Sleep Freq	If an operation frequency lower than the value set at AP.38 is maintained for the time set at AP.37, the operation stops and the PID operation sleep mode starts.
AP.39 PID WakeUp Lev, AP.40 PID WakeUp Mod	Starts the PID operation when in PID operation sleep mode. If AP. 40 is set to 0 (Below Level), the PID operation starts when the feedback variable is less than the value set as the AP. 39 parameter setting. If AP. 40 is set to 1 (Above Level), the operation starts when the feedback variable is higher than the value set at AP. 39. If AP. 40 is set to 2 (Beyond Level), the operation starts when the difference between the reference value and the feedback variable is greater than the value set at AP. 39.

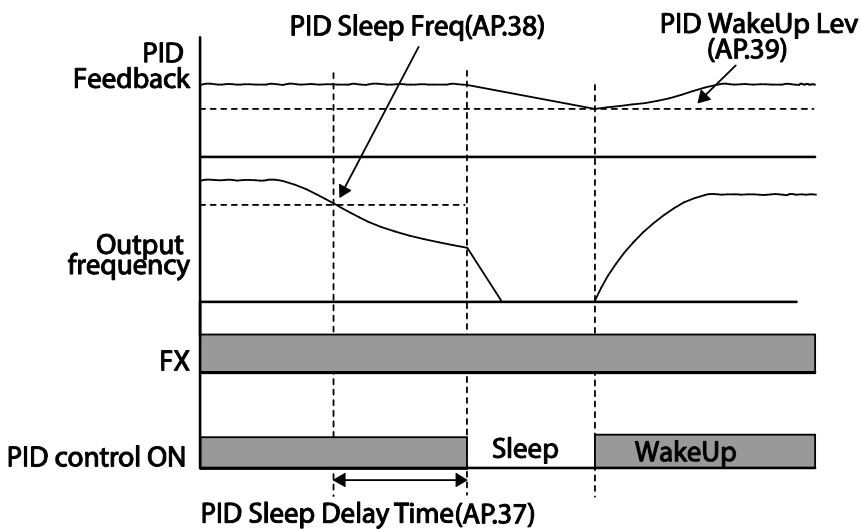

5.8.4 PID Switching (PID Openloop)

When one of the multi-function terminals (In. 65-71) is set to 23 (PID Openloop) and is turned on, the PID operation stops and is switched to general operation. When the terminal turns off, the PID operation starts again.

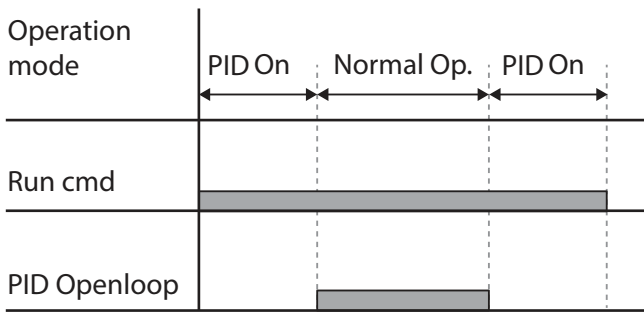

5.9 Auto Tuning

The motor parameters can be measured automatically and can be used for auto torque boost or sensorless vector control.

Example - Auto Tuning Based on 0.75kW, 200V Motor

Group	Code	Name	LCD Display	Parameter Setting	Setting Range	Unit
dr	14	Motor capacity	Motor Capacity	1 0.75 kW	0-15	-
bA	11	Motor pole number	Pole Number	4	2-48	-
	12	Rated slip speed	Rated Slip	40	0-3000	rpm
	13	Rated motor current	Rated Curr	3.6	1.0-1000.0	A
	14	Motor no-load current	Noload curr	1.6	0.5-1000.0	A
	15	Motor rated voltage	Rated Volt	220	170-480	V
	16	Motor efficiency	Efficiency	72	70-100	%
	20	Auto tuning	Auto Tuning	0 None	-	-
	21	Stator resistance	Rs	26.00	Depends on the motor setting	Ω
	22	Leakage inductance	Lsigma	179.4	Depends on the motor setting	mH
	23	Stator inductance	Ls	1544	Depends on the motor setting	mH
24	Rotor time constant	Tr	145	25-5000	ms	

Auto Tuning Default Parameter Setting

Motor Capacity (kW)	Rated Current (A)	No-load Current (A)	Rated Slip Frequency(Hz)	Stator Resistance(Ω)	Leakage Inductance (mH)	
200V	0.2	1.1	0.8	3.33	14.0	40.4
	0.4	2.4	1.4	3.33	6.70	26.9
	0.75	3.4	1.7	3.00	2.600	17.94
	1.5	6.4	2.6	2.67	1.170	9.29
	2.2	8.6	3.3	2.33	0.840	6.63
	3.7	13.8	5.0	2.33	0.500	4.48
	5.5	21.0	7.1	1.50	0.314	3.19
	7.5	28.2	9.3	1.33	0.169	2.844
	11	40.0	12.4	1.00	0.120	1.488
	15	53.6	15.5	1.00	0.084	1.118
	18.5	65.6	19.0	1.00	0.068	0.819
	22	76.8	21.5	1.00	0.056	0.948
400V	0.2	0.7	0.5	3.33	28.00	121.2
	0.4	1.4	0.8	3.33	14.0	80.8
	0.75	2.0	1.0	3.00	7.81	53.9
	1.5	3.7	1.5	2.67	3.52	27.9
	2.2	5.0	1.9	2.33	2.520	19.95
	3.7	8.0	2.9	2.33	1.500	13.45
	5.5	12.1	4.1	1.50	0.940	9.62
	7.5	16.3	5.4	1.33	0.520	8.53
	11	23.2	7.2	1.00	0.360	4.48
	15	31.0	9.0	1.00	0.250	3.38
	18.5	38.0	11.0	1.00	0.168	2.457
	22	44.5	12.5	1.00	0.168	2.844

Auto Tuning Parameter Setting Details

Code	Description						
bA.20 Auto Tuning	Select an auto tuning type and run it. Select one of the options and then press the [ENT] key to run the auto tuning.						
	<table border="1"> <thead> <tr> <th>Setting</th> <th>Function</th> </tr> </thead> <tbody> <tr> <td>0</td> <td>None Auto tuning function is not enabled. Also, if you select one of the auto tuning options and run it, the parameter value will revert back to "0" when the auto tuning is complete.</td> </tr> <tr> <td>1</td> <td>All (rotating type) Measures all motor parameters, including stator resistance (Rs), stator inductance (Lsigma), no-load current (Noload Curr), rotor time constant (Tr), etc., while the motor is rotating. As the motor is rotating while the</td> </tr> </tbody> </table>	Setting	Function	0	None Auto tuning function is not enabled. Also, if you select one of the auto tuning options and run it, the parameter value will revert back to "0" when the auto tuning is complete.	1	All (rotating type) Measures all motor parameters, including stator resistance (Rs), stator inductance (Lsigma), no-load current (Noload Curr), rotor time constant (Tr), etc., while the motor is rotating. As the motor is rotating while the
	Setting	Function					
0	None Auto tuning function is not enabled. Also, if you select one of the auto tuning options and run it, the parameter value will revert back to "0" when the auto tuning is complete.						
1	All (rotating type) Measures all motor parameters, including stator resistance (Rs), stator inductance (Lsigma), no-load current (Noload Curr), rotor time constant (Tr), etc., while the motor is rotating. As the motor is rotating while the						

Code	Description	
		parameters are being measured, if the load is connected to the motor spindle, the parameters may not be measured accurately. For accurate measurements, remove the load attached to the motor spindle. However, note that the rotor time constant (Tr) must be measured in a stopped position.
	2	All (static type) Measures all parameters while the motor is in the stopped position. Measures stator resistance (Rs), stator inductance (Lsigma), no-load current (Noload Curr), rotor time constant (Tr), etc., while the motor is in the stopped position. As the motor is not rotating while the parameters are measured, the measurements are not affected when the load is connected to the motor spindle. However, when measuring parameters, do not rotate the motor spindle on the load side.
	3	Rs+Lsigma (rotating type) Measures parameters while the motor is rotating. The measured motor parameters are used for auto torque boost or sensorless vector control.
	6	Tr (static type) Measures the rotor time constant (Tr) with the motor in the stopped position and Control Mode (dr.09) is set to IM Sensorless.
bA.14 Noload Curr, bA.21 Rs–bA.24 Tr	Displays motor parameters measured by auto tuning. For parameters that are not included in the auto tuning measurement list, the default setting will be displayed.	

Caution

- Perform auto tuning ONLY after the motor has completely stopped running.
- Before you run auto tuning, check the motor pole number, rated slip, rated current, rated voltage and efficiency on the motor's rating plate and enter the data. The default parameter setting is used for values that are not entered.
- When measuring all parameters after selecting 2 (All - static type) at bA20: compared with rotation type auto tuning where parameters are measured while the motor is rotating, parameter values measured with static auto tuning may be less accurate. Inaccuracy of the measured parameters may degrade the performance of sensorless operation. Therefore, run static type auto tuning by selecting 2 (All) only when the motor cannot be rotated (when gearing and belts cannot be separated easily, or when the motor cannot be separated mechanically from the load).

5.10 Sensorless Vector Control

Sensorless vector control is an operation to carry out vector control without the rotation speed feedback from the motor but with an estimation of the motor rotation speed calculated by the inverter. Compared to V/F control, sensorless vector control can generate greater torque at a lower level of current.

Group	Code	Name	LCD Display	Parameter Setting	Setting Range	Unit
dr	09	Control mode	Control Mode	4 IM Sensorless	-	-
	14	Motor capacity	Motor Capacity	Depends on the motor capacity	0-15	-
	18	Base frequency	Base Freq	60	30-400	Hz
In	11	Motor pole number	Pole Number	4	2-48	-
	12	Rated slip speed	Rated Slip	Depends on the motor capacity	0-3000	Hz
	13	Rated motor current	Rated Curr	Depends on the motor capacity	1-1000	A
	14	Motor no-load current	Noload curr	Depends on the motor capacity	0.5-1000	A
	15	Rated motor voltage	Rated Volt	220/380/440/480	170-480	V
	16	Motor efficiency	Efficiency	Depends on the motor capacity	70-100	%
	20	Auto tuning	Auto Tuning	1 All	-	-
Cn	09	Pre-Excite time	PreExTime	1.0	0.0-60.0	s
	10	Pre-Excite amount	Flux Force	100.0	100.0-300.0	%
	20	Sensorless second gain display setting	SL2 G View Sel	1 Yes	0-1	-
	21	Sensorless speed controller proportional gain 1	ASR-SL P Gain1	Depends on the motor capacity	0-5000	%
	22	Sensorless speed controller integral gain 1	ASR-SL I Gain1	Depends on the motor capacity	10-9999	ms
	23*	Sensorless speed controller proportional gain 2	ASR-SL P Gain2	Depends on the motor capacity	1-1000	%
	24*	Sensorless speed controller integral gain 2	ASR-SL I Gain2	Depends on the motor capacity	1-1000	%
	26*	Flux estimator proportional gain	Flux P Gain	Depends on the motor capacity	10-200	%
	27*	Flux estimator integral gain	Flux I Gain	Depends on the motor capacity	10-200	%
	28*	Speed estimator proportional gain	S-Est P Gain1	Depends on the motor capacity	0-32767	-
29*	Speed estimator integral gain1	S-Est I Gain1	Depends on the motor capacity	100-1000	-	

Learning Advanced Features

Group	Code	Name	LCD Display	Parameter Setting	Setting Range	Unit
	30*	Speed estimator integral gain2	S-Est I Gain2	Depends on the motor capacity	100-10000	-
	31*	Sensorless current controller proportional gain	ACR SL P Gain	75	10-1000	-
	32*	Sensorless current controller integral gain	ACR SL I Gain	120	10-1000	-
	52	Torque controller output filter	Torque Out LPF	0	0-2000	ms
	53	Torque limit setting	Torque Lmt Src	0 Keypad-1	0-12	-
	54	Forward direction retrograde torque limit	FWD +Trq Lmt	180.0	0.0-200.0	%
	55	Forward direction regenerative torque limit	FWD -Trq Lmt	180.0	0.0-200.0	%
	56	Reverse direction retrograde torque limit	REV +Trq Lmt	180.0	0.0-200.0	%
	57	Reverse direction regenerative torque limit	REV -Trq Lmt	180.0	0.0-200.0	%
	85*	Flux estimator proportional gain 1	Flux P Gain1	370	100-700	-
	86*	Flux estimator proportional gain 2	Flux P Gain2	0	0-100	-
	87*	Flux estimator proportional gain 3	Flux P Gain3	100	0-500	-
	88*	Flux estimator integral gain 1	Flux I Gain1	50	0-200	-
	89*	Flux estimator integral gain2	Flux I Gain2	50	0-200	-
	90*	Flux estimator integral gain 3	Flux I Gain3	50	0-200	-
	91*	Sensorless voltage compensation 1	SL Volt Comp1	30	0-60	-
	92*	Sensorless voltage compensation 2	SL Volt Comp2	20	0-60	-
	93*	Sensorless voltage compensation 3	SL Volt Comp3	20	0-60	-
	94*	Sensorless field weakening start frequency	SL FW Freq	95.0	80.0-110.0	%
	95*	Sensorless gain switching frequency	SL Fc Freq	2.00	0.00-8.00	Hz

*Cn.23-32 and Cn.85-95 can be displayed only when Cn.20 is set to 1 (Yes).

Caution

For high-performance operation, the parameters of the motor connected to the inverter output must be measured. Use auto tuning (bA.20 Auto Tuning) to measure the parameters before you run sensorless vector operation. To run high-performance sensorless vector control, the inverter and the motor must have the same capacity. If the motor capacity is smaller than the inverter capacity by more than two levels, control may be inaccurate. In that case, change the control mode to V/F control. When operating with sensorless vector control, do not connect multiple motors to the inverter output.

5.10.1 Sensorless Vector Control Operation Setting

To run sensorless vector control operation, set dr.09 (Control Mode) to 4 (IM sensorless), select the capacity of the motor you will use at dr.14 (Motor Capacity), and select the appropriate codes to enter the rating plate information of the motor.

Code	Input (Motor Rating Plate Information)
drv.18 Base Freq	Base frequency
bA.11 Pole Number	Motor pole number
bA.12 Rated Slip	Rated slip
bA.13 Rated Curr	Rated current
bA.15 Rated Volt	Rated voltage
bA.16 Efficiency	Efficiency (when no information is on the rating plate, default values are used.)

After setting each code, set bA.20 (Auto tuning) to 1 (All - rotation type) or 2 (All - static type) and run auto tuning. Because rotation type auto tuning is more accurate than static type auto tuning, select 1 (All - rotation type) and run auto tuning if you can rotate the motor.

Note**Excitation Current**

A motor can be operated only after magnetic flux is generated by current flowing through a coil. The power supply used to generate the magnetic flux is called the excitation current. The stator coil that is used with the inverter does not have a permanent magnetic flux, so the magnetic flux must be generated by supplying an excitation current to the coil before operating the motor.

Sensorless Vector Control Operation Setting Details

Code	Description	
Cn.20 SL2 G View Sel	Setting	Function
	0	No
	1	Yes
	<p>Does not display sensorless (II) vector control gain code.</p> <p>Allows the user to set various gains applied when the motor rotates faster than medium speed (approx. 1/2 of the base frequency) through sensorless (II) vector control.</p> <p>Codes available when setting to 1 (Yes): Cn.23 ASR-SL P Gain2/Cn.24 ASR-SL I Gain2/Cn.26 Flux P Gain/Cn.27 Flux I Gain Gain3/Cn.28 S-Est P Gain1/Cn.29 S-Est I Gain1/Cn.30 S-Est I Gain1/Cn.31 ACR SL P Gain/Cn.32 ACR SL I Gain</p>	
Cn.09 PreExTime	Sets pre-excitation time. Pre-excitation is used to start the operation after performing excitation up to the motor's rated flux.	
Cn.10 Flux Force	<p>Allows for the reduction of the pre-excitation time. The motor flux increases up to the rated flux with the time constant as shown in the following figure. To reduce the time taken to reach the rated flux, a higher motor flux base value than the rated flux must be provided. When the magnetic flux reaches the rated flux, the provided motor flux base value is reduced.</p>	
Cn.11 Hold Time	<p>Sets the zero-speed control time (hold time) in the stopped position. The output is blocked after zero-speed operation for a set period when the motor decelerates and is stopped by a stop command.</p>	
Cn.21 ASR-SL P Gain1, Cn.22 ASR-SL I Gain1	Changes the speed PI controller gain during sensorless vector control. For a PI speed controller, P gain is a proportional gain for the speed deviation. If speed deviation becomes higher than the torque the output command	

Code	Description																		
	<p>increases accordingly. As the value increases, the faster the speed deviation decreases. The speed controller I gain is the integral gain for speed deviation. It is the time taken for the gain to reach the rated torque output command while a constant speed deviation continues. The lower the value becomes, the faster the speed deviation decreases.</p>																		
<p>Cn.23 ASR-SL P Gain2, Cn.24 ASR-SL I Gain2</p>	<p>Appears only when 1 (Yes) is selected for Cn.20 (SL2 G view Sel). The speed controller gain can be increased to more than the medium speed for sensorless vector control. Cn.23 ASR-SL P Gain2 is set as a percentage of the low speed gain Cn.21 ASR-SL P Gain1 - if P Gain 2 is less than 100.0%, the responsiveness decreases. For example, if Cn.21 ASR-SL P Gain1 is 50.0% and Cn.23 ASR-SL P Gain2 is 50.0%, the actual middle speed or faster speed controller P gain is 25.0%.</p> <p>Cn.24 ASR-SL I Gain2 is also set as a percentage of the Cn.22 ASR-SL I Gain1. For I gain, the smaller the I gain 2 becomes, the slower the response time becomes. For example, if Cn.22 ASR-SL I Gain1 is 100ms and Cn.24 ASR-SL I Gain2 is 50.0%, the middle speed or faster speed controller I gain is 200 ms. The controller gain is set according to the default motor parameters and Acc/Dec time.</p>																		
<p>Cn.26 Flux P Gain, Cn.27 Flux I Gain, Cn.85-87 Flux P Gain13, Cn.88-90 Flux I Gain1-3</p>	<p>Sensorless vector control requires the rotor flux estimator. For the adjustment of flux estimator gain, refer to 5.10.2 Sensorless Vector Control Operation Guide to on page 152.</p>																		
<p>Cn.28 S-Est P Gain1, Cn.29 S-Est I Gain1, Cn.30 S-Est I Gain2</p>	<p>Speed estimator gain for sensorless vector control can be adjusted. To adjust speed estimator gain, refer 5.10.2 Sensorless Vector Control Operation Guide to on page 152.</p>																		
<p>Cn.31 ACR SL P Gain, Cn.32 ACR SL I Gain</p>	<p>Adjusts the P and I gains of the sensorless current controller. For the adjustment of sensorless current controller gain, refer to 5.10.2 Sensorless Vector Control Operation Guide to on page 152.</p>																		
<p>Cn.53 Torque Lmt Src</p>	<p>Select a type of torque limit setting, using the keypad, terminal block analog input (V1 and I2) or communication power. When setting torque limit, adjust the torque size by limiting the speed controller output. Set the retrograde and regenerative limits for forward and reverse operation.</p> <table border="1" data-bbox="400 1373 1234 1761"> <thead> <tr> <th data-bbox="400 1373 642 1406">Setting</th> <th data-bbox="642 1373 779 1406">Function</th> </tr> </thead> <tbody> <tr> <td data-bbox="400 1406 495 1439">0</td> <td data-bbox="495 1406 1234 1439">KeyPad-1</td> </tr> <tr> <td data-bbox="400 1439 495 1472">1</td> <td data-bbox="495 1439 1234 1472">KeyPad-2</td> </tr> <tr> <td data-bbox="400 1472 495 1505">2</td> <td data-bbox="495 1472 1234 1505">V1</td> </tr> <tr> <td data-bbox="400 1505 495 1537">4</td> <td data-bbox="495 1505 1234 1537">V2</td> </tr> <tr> <td data-bbox="400 1537 495 1570">5</td> <td data-bbox="495 1537 1234 1570">I2</td> </tr> <tr> <td data-bbox="400 1570 495 1644">6</td> <td data-bbox="495 1570 1234 1644">Int 485</td> </tr> <tr> <td data-bbox="400 1644 495 1717">8</td> <td data-bbox="495 1644 1234 1717">FieldBus</td> </tr> <tr> <td data-bbox="400 1717 495 1761">12</td> <td data-bbox="495 1717 1234 1761">Pulse</td> </tr> </tbody> </table>	Setting	Function	0	KeyPad-1	1	KeyPad-2	2	V1	4	V2	5	I2	6	Int 485	8	FieldBus	12	Pulse
Setting	Function																		
0	KeyPad-1																		
1	KeyPad-2																		
2	V1																		
4	V2																		
5	I2																		
6	Int 485																		
8	FieldBus																		
12	Pulse																		

Code	Description
	The torque limit can be set up to 200% of the rated motor torque.
Cn.54 FWD +Trq Lmt	Sets the torque limit for forward retrograde (motoring) operation.
Cn.55 FWD -Trq Lmt	Sets the torque limit for forward regenerative operation.
Cn.56 REV +Trq Lmt	Sets the torque limit for reverse retrograde (motoring) operation.
Cn.57 REV -Trq Lmt	Sets the torque limit for reverse regenerative operation.
In.02 Torque at 100%	Sets the maximum torque. For example, if In.02 is set to 200% and an input voltage (V1) is used, the torque limit is 200% when 10V is entered. However, when the VI terminal is set up with the factory default setting and the torque limit setup uses a method other than the keypad, check the parameter settings in the monitor mode. In the Config Mode CNF.21-23 (only displayed when using LCD keypad), select 21 (Torque limit).
Cn.91-93 SL Volt Comp1-3	Adjust output voltage compensation values for sensorless vector control. For output voltage compensation, refer to 5.10.2 Sensorless Vector Control Operation Guide to on page 152.
Cn.52 Torque Out LPF	Sets the time constant for torque command by setting the torque controller output filter.

Caution

Adjust the controller gain according to the load's characteristics. However, the motor can overheat or the system may become unstable depending on the controller gain settings.

Note

Speed controller gain can improve the speed control waveform while monitoring the changes in speed. If speed deviation does not decrease quickly, increase the speed controller P gain or decrease I gain (time in ms). However, if the P gain is increased too high or I gain is decreased too low, severe vibration may occur. If oscillation occurs in the speed waveform, try to increase I gain (ms) or reduce P gain to adjust the waveform.

5.10.2 Sensorless Vector Control Operation Guide

Problem	Relevant function code	Troubleshooting
The amount of starting torque is insufficient.	bA.24 Tr Cn.09 PreExTime Cn.10 Flux Force Cn.31 ACR SL P Gain Cn.54-57 Trq Lmt Cn.93 SL Volt Comp3	Set the value of Cn. 90 to be more than 3 times the value of bA.24 or increase the value of Cn.10 by increments of 50%. If the value of Cn.10 is high, an overcurrent trip at start can occur. In this case, reduce the value of Cn.31 by decrements of 10.

Problem	Relevant function code	Troubleshooting
		Increase the value of Trg Lmt (Cn.54-57) by increments of 10%. Increase the value of Cn.93 by increments of 5.
The output frequency is higher than the base frequency during no-load operation at low speed (10Hz or lower).	Cn.91 SL Volt Comp1	Decrease the value of Cn.91 by decrements of 5.
The motor hunts or the amount of torque is not sufficient while the load is increasing at low speed (10Hz or lower).	Cn.04 Carrier Freq Cn.21 ASR-SL P Gain1 Cn.22 ASR-SL I Gain1 Cn.93 SL Volt Comp3	If the motor hunts at low speed, increase the value of Cn.22 by increments of 50m/s, and if hunting does not occur, increase the value of Cn.21 to find the optimal operating condition. If the amount of torque is insufficient, increase the value of Cn.93 by increments of 5. If the motor hunts or the amount of torque is insufficient in the 5-10Hz range, decrease the value of Cn.04 by increments of 1kHz (if Cn.04 is set to exceed 3kHz).
The motor hunts or overcurrent trip occurs in regenerative load at low speed (10 Hz or lower).	Cn.92 SL Volt Comp2 Cn.93 SL Volt Comp3	Increase the value of Cn.92-93 by increments of 5 at the same time.
Over voltage trip occurs due to sudden acceleration/deceleration or sudden load fluctuation (with no brake resistor installed) at mid speed (30Hz or higher).	Cn.24 ASR-SL I Gain2	Decrease the value of Cn.2 by decrements of 5%.
Over current trip occurs due to sudden load fluctuation at high speed (50 Hz or higher).	Cn.54-57 Trq Lmt Cn.94 SL FW Freq	Decrease the value of Cn.54-57 by decrements of 10% (if the parameter setting is 150% or higher). Increase/decrease the value of Cn.94 by increments/decrements of 5% (set below 100%).
The motor hunts when the load increases from the base frequency or higher.	Cn.22 ASR-SL I Gain1 Cn.23 ASR-SL I Gain2	Increase the value of Cn.22 by increments of 50m/s or decrease the value of Cn.24 by decrements of 5%.
The motor hunts as the load increases.	Cn.28 S-Est P Gain1 Cn.29 S-Est I Gain1	At low speed (10Hz or lower), increase the value of Cn.29 by increments of 5. At mid speed (30 Hz or higher), increase the value of Cn.28 by increments of 500. If the parameter setting is too extreme, over current

Problem	Relevant function code	Troubleshooting
		trip may occur at low speed.
The motor speed level decreases.	bA.20 Auto Tuning	Select 6. Tr (static type) from bA. 24 and run bA.24 Rotor time constant tuning.

*Hunting: Symptom of irregular vibration of the equipment.

5.11 Kinetic Energy Buffering Operation

When the input power supply is disconnected, the inverter's DC link voltage decreases, and a low voltage trip occurs blocking the output. A kinetic energy buffering operation uses regenerative energy generated by the motor during the blackout to maintain the DC link voltage. This extends the time for a low voltage trip to occur, after an instantaneous power interruption.

Group	Code	Name	LCD Display	Parameter Setting		Setting Range	Unit
Cn	77	Kinetic energy buffering selection	KEB Select	1	Yes	-	-
	78	Kinetic energy buffering start level	KEB Start Lev	130		110–140	%
	79	Kinetic energy buffering stop level	KEB Stop Lev	135		125–145	%
	80	Kinetic energy buffering gain	KEB Gain	1000		1–20000	-

Kinetic Energy Buffering Operation Setting Details

Code	Description						
Cn.77 KEB Select	Select the kinetic energy buffering operation when the input power is disconnected.						
	<table border="1"> <thead> <tr> <th>Setting</th> <th>Function</th> </tr> </thead> <tbody> <tr> <td>0 No</td> <td>General deceleration is carried out until a low voltage trip occurs.</td> </tr> <tr> <td>1 Yes</td> <td>The inverter power frequency is controlled and the regeneration energy from the motor is charged by the inverter.</td> </tr> </tbody> </table>	Setting	Function	0 No	General deceleration is carried out until a low voltage trip occurs.	1 Yes	The inverter power frequency is controlled and the regeneration energy from the motor is charged by the inverter.
	Setting	Function					
0 No	General deceleration is carried out until a low voltage trip occurs.						
1 Yes	The inverter power frequency is controlled and the regeneration energy from the motor is charged by the inverter.						
Cn.78 KEB Start Lev, Cn.79 KEB Stop Lev	Sets the start and stop points of the kinetic energy buffering operation. The set values must be based on the low voltage trip level as 100% and the stop level (Cn. 79) must be set higher than the start level (Cn.78).						
Cn.80 KEB Gain	This is the gain used to control the kinetic energy buffering operation using the amount of load-side inertia moment. If the load inertia is high, use a lower gain value, and if the load inertia is low, use a higher gain value. If input power is disconnected and the motor vibrates severely while the						

Code	Description
	kinetic energy buffering operation is carried out, set the gain (Cn.80: KEB Gain) at half the previously set value. If the gain is lowered too much, a low voltage trip may occur during the kinetic energy buffering operation (KEB).

Caution

Depending on the duration of Instantaneous power interruptions and the amount of load inertia, a low voltage trip may occur even during a kinetic energy buffering operation. Motors may vibrate during kinetic energy buffering operation for some loads except variable torque load (for example, fan or pump loads).

5.12 Torque Control

When the motor output torque is greater than the load, the speed of motor becomes too fast. To prevent this, set the speed limit. (The torque control function cannot be used while the speed limit function is running.)

The torque control function controls the motor to maintain the preset torque value. The motor rotation speed maintains the speed constantly when the output torque and load torque of the motor keep a balance. Therefore, the motor rotation speed is decided by the load when controlling the torque.

Torque control setting option

Group	Code	Name	LCD Display	Parameter Setting	Unit
dr	09	Control mode	Control Mode	4 IM Sensorless	-
	10	Torque control	Torque Control	1 Yes	-

Torque control setting option details

Group	Code	Name	Parameter Setting	Unit
dr	02	Cmd Torque	- 0.0	%
	08	Trq Ref Src	0 Keypad-1	-
	09	Control Mode	4 IM Sensorless	-
	10	Torque Control	1 Yes	-
	22	(+) Trq Gain	- 50-150	%
	23	(-) Trq Gain	- 50-150	%
bA	20	Auto Tuning	1 Yes	-
Cn	62	Speed LmtSrc	0 Keypad-1	-
	63	FWD Speed Lmt	- 60.00	Hz

Group	Code	Name	Parameter Setting		Unit
	64	REV Speed Lmt	-	60.00	Hz
	65	Speed Lmt Gain	-	100	%
In	65-71	Px Define	35	Speed/Torque	-
OU	31-33	Relay x or Q1	27	Torque Dect	-
	59	TD Level	-	100	%
	60	TD Band	-	5.0	%

Note

- To operate in torque control mode, basic operation conditions must be set. For more information, refer to *Sensorless* Vector Control Operation Guide to on page 152.
- The torque control cannot be used in a low speed regeneration area or low load conditions.
- If you change the rotation direction while operating, an over current trip or low speed reverse direction error will be generated.

Torque reference setting option

The torque reference can be set using the same method as the target frequency setting. If Torque Control Mode is selected, the target frequency is not used.

Group	Code	Name	LCD Display	Parameter Setting		Unit
dr	08	Torque reference setting	Trq Ref Src	0	Keypad-1	-
				1	Keypad-2	
				2	V1	
				6	Int 485	
Cn	02	Torque command	Cmd Torque	-180-180		%
	62	Speed limit setting	Speed LmtSrc	0	Keypad-1	-
				1	Keypad-2	
				2	V1	
				4	V2	
				5	I2	
	6	Int 485				
63	Positive-direction speed limit	FWD Speed Lmt	0-Maximum frequency		Hz	
64	Negative-direction speed limit	REV Speed Lmt	0- Maximum frequency		Hz	
65	Speed limit operation gain	Speed Lmt Gain	100-5000		%	
In	02	Torque at maximum analog input	Torque at 100%	-12.00-12.00		mA

Group	Code	Name	LCD Display	Parameter Setting	Unit
CNF*	21	Monitor mode display 1	Monitor Line-1	1 Speed	
	22	Monitor mode display 2	Monitor Line-2	2 Output Current	
	23	Monitor mode display 3	Monitor Line-3	3 Output Voltage	

*Available on LCD keypad only.

Torque reference setting details

Code	Description									
dr-08	Select an input method to use as the torque reference.									
	<table border="1"> <thead> <tr> <th>Parameter Setting</th> <th>Description</th> </tr> </thead> <tbody> <tr> <td>0 Keypad-1</td> <td rowspan="2">Sets the torque reference with the keypad.</td> </tr> <tr> <td>1 Keypad-2</td> </tr> <tr> <td>2 V1</td> <td>Sets the torque reference using the voltage or current input terminal of the terminal block.</td> </tr> <tr> <td>6 Int 485</td> <td>Sets the torque reference with the communication terminal of the terminal block.</td> </tr> </tbody> </table>	Parameter Setting	Description	0 Keypad-1	Sets the torque reference with the keypad.	1 Keypad-2	2 V1	Sets the torque reference using the voltage or current input terminal of the terminal block.	6 Int 485	Sets the torque reference with the communication terminal of the terminal block.
	Parameter Setting	Description								
	0 Keypad-1	Sets the torque reference with the keypad.								
	1 Keypad-2									
2 V1	Sets the torque reference using the voltage or current input terminal of the terminal block.									
6 Int 485	Sets the torque reference with the communication terminal of the terminal block.									
Cn-02	The torque reference can be set up to 180% of the maximum rated motor torque.									
In-02	Sets the maximum torque. You can check the set maximum torque in Monitor (MON) mode.									
CNF-21-23	Select a parameter from the Config(CNF) mode and then select(19 Torque Ref).									

Speed limit details

Code	Description								
Cn-62	Select a method for setting the speed limit value.								
	<table border="1"> <thead> <tr> <th>Parameter Setting</th> <th>Description</th> </tr> </thead> <tbody> <tr> <td>0 Keypad-1</td> <td rowspan="2">Sets the speed limit value with the keypad.</td> </tr> <tr> <td>1 Keypad-2</td> </tr> <tr> <td>2 V1</td> <td rowspan="2">Sets the speed limit value using the same method as the frequency command. You can check the setting in Monitor (MON) mode.</td> </tr> <tr> <td>6 Int 485</td> </tr> </tbody> </table>	Parameter Setting	Description	0 Keypad-1	Sets the speed limit value with the keypad.	1 Keypad-2	2 V1	Sets the speed limit value using the same method as the frequency command. You can check the setting in Monitor (MON) mode.	6 Int 485
	Parameter Setting	Description							
	0 Keypad-1	Sets the speed limit value with the keypad.							
	1 Keypad-2								
2 V1	Sets the speed limit value using the same method as the frequency command. You can check the setting in Monitor (MON) mode.								
6 Int 485									
Cn-63	Sets the positive-direction speed limit value.								
Cn-64	Sets the negative-direction speed limit value.								
Cn-65	Sets the decrease rate of the torque reference when the motor speed exceeds the speed limit value.								

Code	Description
CNF-21~23	Select a parameter from the Config (CNF) mode and then select 21 Torque Bias.
In 65-71	Select a multi-functional input terminal to set as the (35 Speed/Torque). If you turn on the terminal while the operation is stopped, it operates in vector control (speed limit) mode.

5.13 Energy Saving Operation

5.13.1 Manual Energy Saving Operation

If the inverter output current is lower than the current which is set at bA.14 (Noload Curr), the output voltage must be reduced as low as the level set at Ad.51 (Energy Save). The voltage before the energy saving operation starts will become the base value of the percentage. Manual energy saving operation will not be carried out during acceleration and deceleration.

Group	Code	Name	LCD Display	Parameter Setting		Setting Range	Unit
Ad	50	Energy saving operation	E-Save Mode	1	Manual	-	-
	51	Energy saving amount	Energy Save	30		0-30	%

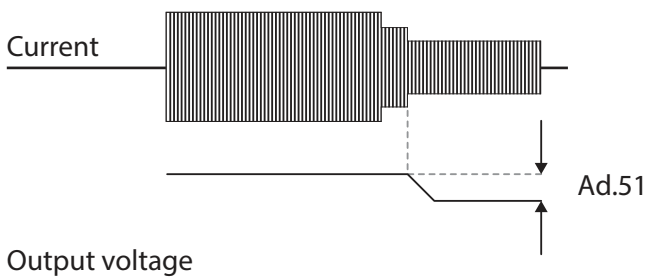

5.13.2 Automatic Energy Saving Operation

The amount of energy saving can be automatically calculated based on the rated motor current (bA.13) and the no-load current (bA.14). From the calculations, the output voltage can be adjusted.

Group	Code	Name	LCD Display	Parameter Setting		Setting Range	Unit
Ad	50	Energy saving operation	E-Save Mode	2	Auto	-	-

 **Caution**

If operation frequency is changed or acceleration and /deceleration is carried out by a stop command during the energy saving operation, the actual Acc/Dec time may take longer than the set Acc/Dec time due to the time required to return to the general operation from the energy saving operation.



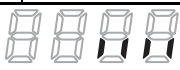

5.14 Speed Search Operation

This operation is used to prevent fault trips that can occur while the inverter output voltage is disconnected and the motor is idling. Because this feature estimates the motor rotation speed based on the inverter output current, it does not give the exact speed.

Group	Code	Name	LCD Display	Parameter Setting		Setting Range	Unit
Cn	70	Speed search mode selection	SS Mode	0	Flying Start-1	-	-
	71	Speed search operation selection	Speed Search	0000*		-	bit
	72	Speed search reference current	SS Sup-Current	-	Below 75kW	80-200	%
	73	Speed search proportional gain	SS P-Gain	100		0-9999	-
	74	Speed search integral gain	SS I-Gain	200		0-9999	-
	75	Output block time before speed search	SS Block Time	1.0		0-60	sec
OU	31	Multi-function relay 1 item	Relay 1	19	Speed Search	-	-
	33	Multi-function output 1 item	Q1 Define				

*Displayed as  on the Keypad.

Speed Search Operation Setting Details

Code	Description		
Cn.70 SS Mode	Select a speed search type.		
	Setting		Function
	0	Flying Start-1	The speed search is carried out as it controls the inverter output current during idling below the Cn.72 (SS Sup-Current) parameter setting. If the direction of the idling motor and the direction of operation command at restart are the same, a stable speed search function can be performed at about 10 Hz or lower. However, if the direction of the idling motor and the direction of operation command at restart are different, the speed search does not produce a satisfactory result because the direction of idling cannot be established.
1	Flying Start-2	The speed search is carried out as it PI controls the ripple current which is generated by the counter electromotive force during no-load rotation. Because this mode establishes the direction of the idling motor (forward/reverse), the speed search function is stable regardless of the direction of the idling motor and direction of operation command. However because the ripple current is used which is generated by the counter electromotive force at idle (the counter electromotive force is proportional to the idle speed), the idle frequency is not determined accurately and re-acceleration may start from zero speed when the speed search is performed for the idling motor at low speed (about 10 - 15 Hz, though it depends on motor characteristics).	
Cn.71 Speed Search	Speed search can be selected from the following 4 options. If the top display segment is on it is enabled (On), and if the bottom segment is on it is disabled (Off).		
	Item	Bit Setting On Status	Bit setting Off Status
	Keypad		
LCD keypad			

Code	Description																													
	<p>Type and Functions of Speed Search Setting</p> <table border="1"> <thead> <tr> <th colspan="4">Setting</th> <th rowspan="2">Function</th> </tr> <tr> <th>bit4</th> <th>bit3</th> <th>bit2</th> <th>bit1</th> </tr> </thead> <tbody> <tr> <td></td> <td></td> <td></td> <td style="text-align: center;">✓</td> <td>Speed search for general acceleration</td> </tr> <tr> <td></td> <td></td> <td style="text-align: center;">✓</td> <td></td> <td>Initialization after a fault trip</td> </tr> <tr> <td></td> <td style="text-align: center;">✓</td> <td></td> <td></td> <td>Restart after instantaneous power interruption</td> </tr> <tr> <td style="text-align: center;">✓</td> <td></td> <td></td> <td></td> <td>Starting with power-on</td> </tr> </tbody> </table> <ul style="list-style-type: none"> <p>Speed search for general acceleration: If bit 1 is set to 1 and the inverter operation command runs, acceleration starts with speed search operation. When the motor is rotating under load, a fault trip may occur if the operation command is run for the inverter to provide output voltage. The speed search function prevents such fault trip from occurring.</p> <p>Initialization after a fault trip: If Bit 2 is set to 1 and Pr.08 (RST Restart) is set to 1 (Yes), the speed search operation automatically accelerates the motor to the operation frequency used before the fault trip, when the [Reset] key is pressed (or the terminal block is initialized) after a fault trip.</p> <p>Automatic restart after reset of a fault trip: If bit 3 is set to 1, and if a low voltage trip occurs due to a power interruption but the power is restored before the internal power shuts down, the speed search operation accelerates the motor back to its frequency reference before the low voltage trip.</p> <p>If an instantaneous power interruption occurs and the input power is disconnected, the inverter generates a low voltage trip and blocks the output. When the input power returns, the operation frequency before the low voltage trip and the voltage is increased by the inverter's inner PI control.</p> <p>If the current increases above the value set at Cn.72, the voltage stops increasing and the frequency decreases (t1 zone). If the current decreases below the value set at Cn.27, the voltage increases again and the frequency stops decelerating (t2 zone). When the normal frequency and voltage are resumed, the speed search operation accelerates the motor back to its frequency reference before the fault trip.</p>	Setting				Function	bit4	bit3	bit2	bit1				✓	Speed search for general acceleration			✓		Initialization after a fault trip		✓			Restart after instantaneous power interruption	✓				Starting with power-on
Setting				Function																										
bit4	bit3	bit2	bit1																											
			✓	Speed search for general acceleration																										
		✓		Initialization after a fault trip																										
	✓			Restart after instantaneous power interruption																										
✓				Starting with power-on																										

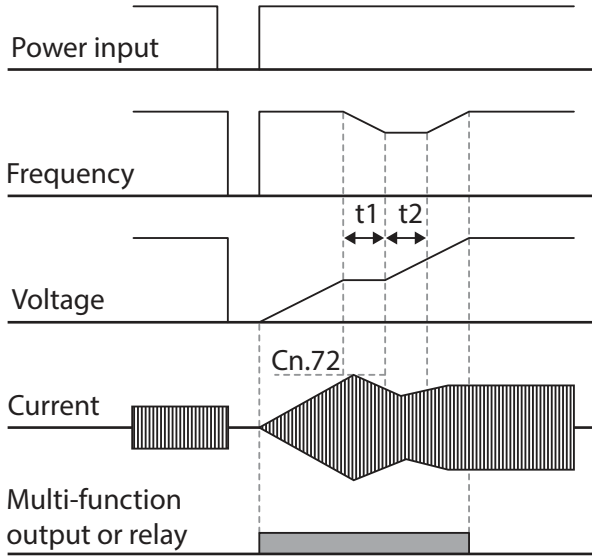
Code	Description
	 <p>• Starting with power-on: Set bit 4 to 1 and Ad.10 (Power-on Run) to 1 (Yes). If inverter input power is supplied while the inverter operation command is on, the speed search operation will accelerate the motor up to the frequency reference.</p>
Cn.72 SS Sup-Current	The amount of current flow is controlled during speed search operation based on the motor's rated current. If Cn.70 (SS mode) is set to 1 (Flying Start-2), this code is not visible.
Cn.73 SS P/I-Gain, Cn.75 SS Block Time	The P/I gain of the speed search controller can be adjusted. If Cn.70 (SS Mode) is set to 1 (Flying Start-2), different factory defaults based on motor capacity are used and defined in dr.14 (Motor Capacity).

Note

- If operated within the rated output, the S100 series inverter is designed to withstand instantaneous power interruptions within 15 ms and maintain normal operation. Based on the rated heavy load current, safe operation during an instantaneous power interruption is guaranteed for 200V and 400V inverters (whose rated input voltages are 200-230 VAC and 380-460 VAC respectively).
- The DC voltage inside the inverter may vary depending on the output load. If the power interruption time is longer than 15 ms, a low voltage trip may occur.

 **Caution**

When operating in sensorless II mode while the starting load is in free-run, the speed search function (for general acceleration) must be set for smooth operation. If the speed search function is not set, an overcurrent trip or overload trip may occur.

5.15 Auto Restart Settings

When inverter operation stops due to a fault and a fault trip is activated, the inverter automatically restarts based on the parameter settings.

Group	Code	Name	LCD Display	Parameter Setting		Setting Range	Unit
Pr	08	Select start at trip reset	RST Restart	0	No	0-1	-
	09	Auto restart count	Retry Number	0		0-10	-
	10	Auto restart delay time	Retry Delay	1.0		0.0-60.0	s
Cn	71	Select speed search operation	Speed Search	-		0000*-1111	bit
	72	Speed search startup current	SS Sup-Current	150		80-200	%
	73	Speed search proportional gain	SS P-Gain	100		0-9999	
	74	Speed search integral gain	SS I-Gain	200		0-9999	
	75	Output block time before speed search.	SS Block Time	1.0		0.0-60.0	s

*Displayed as  on the keypad.

Auto Restart Setting Details

Code	Description
Pr.08 RST Restart, Pr.09 Retry Number, Pr.10 Retry Delay	<p>Only operates when Pr.08 (RST Restart) is set to 1(Yes). The number of attempts to try the auto restart is set at Pr.09 (Auto Restart Count).</p> <p>If a fault trip occurs during operation, the inverter automatically restarts after the set time programmed at Pr.10 (Retry Delay). At each restart, the inverter counts the number of tries and subtracts it from the number set at Pr.09 until the retry number count reaches 0.</p> <p>After an auto restart, if a fault trip does not occur within 60 sec, it will increase the restart count number. The maximum count number is limited by the number set at Pr.09 (Auto Restart Count).</p> <p>If the inverter stops due to low voltage, emergency stop (Bx), inverter overheating, or hardware diagnosis, an auto restart is not activated. At auto restart, the acceleration options are identical to those of speed search</p>

Code	Description
	operation. Codes Cn.72-75 can be set based on the load. Information about the speed search function can be found at 5.14 Speed Search Operation on page 159.

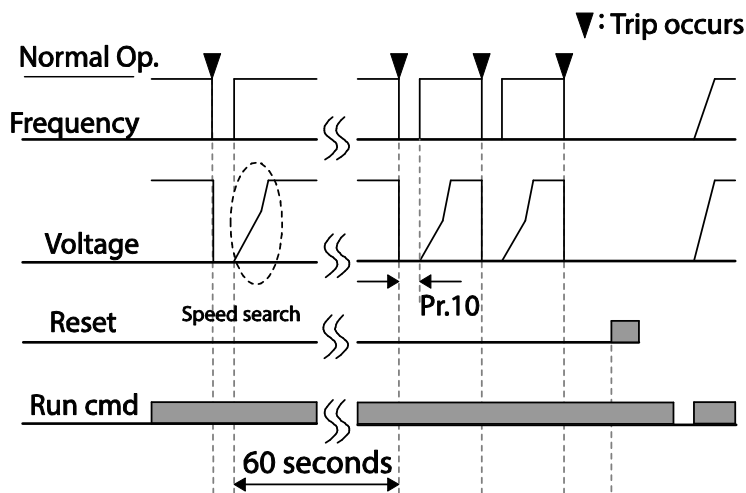

Auto restart trial	2	1	2	1	0	2
--------------------	---	---	---	---	---	---

[Example of auto restart with a setting of 2]

Caution

If the auto restart number is set, be careful when the inverter resets from a fault trip. The motor may automatically start to rotate.

5.16 Operational Noise Settings (carrier frequency settings)

Group	Code	Name	LCD Display	Parameter Setting	Setting Range	Unit
Cn	04	Carrier Frequency	Carrier Freq	3.0	1.0-15.0	kHz
	05	Switching Mode	PWM* Mode	0	Normal PWM	0-1

* PWM: Pulse width modulation

Operational Noise Setting Details

Code	Description																			
Cn.04 Carrier Freq	Adjust motor operational noise by changing carrier frequency settings. Power transistors (IGBT) in the inverter generate and supply high frequency switching voltage to the motor. The switching speed in this process refers to the carrier frequency. If the carrier frequency is set high, it reduces operational noise from the motor, and if the carrier frequency is set low, it increases operational noise from the motor.																			
Cn.05 PWM Mode	<p>The heat loss and leakage current from the inverter can be reduced by changing the load rate option at Cn.05 (PWM Mode). Selecting 1 (LowLeakage PWM) reduces heat loss and leakage current, compared to when 0 (Normal PWM) is selected. However, it increases the motor noise. Low leakage PWM uses 2 phase PWM modulation mode, which helps minimize degradation and reduces switching loss by approximately 30%.</p> <table border="1"> <thead> <tr> <th rowspan="3">Item</th> <th colspan="2">Carrier frequency</th> </tr> <tr> <th>1.0kHz</th> <th>15kHz</th> </tr> <tr> <th>Low Leakage PWM</th> <th>Normal PWM</th> </tr> </thead> <tbody> <tr> <td>Motor noise</td> <td>↑</td> <td>↓</td> </tr> <tr> <td>Heat generation</td> <td>↓</td> <td>↑</td> </tr> <tr> <td>Noise generation</td> <td>↓</td> <td>↑</td> </tr> <tr> <td>Leakage current</td> <td>↓</td> <td>↑</td> </tr> </tbody> </table>	Item	Carrier frequency		1.0kHz	15kHz	Low Leakage PWM	Normal PWM	Motor noise	↑	↓	Heat generation	↓	↑	Noise generation	↓	↑	Leakage current	↓	↑
Item	Carrier frequency																			
	1.0kHz		15kHz																	
	Low Leakage PWM	Normal PWM																		
Motor noise	↑	↓																		
Heat generation	↓	↑																		
Noise generation	↓	↑																		
Leakage current	↓	↑																		

Note

Carrier Frequency at Factory Default Settings (0.4-22kW)

- Normal load: 2kHz (Max 5kHz)
- Heavy load: 3kHz (Max 15kHz)

S100 Series Inverter Derating Standard

- S100 inverter is designed to respond to two types of load rates. Heavy load (heavy duty) and normal load (normal duty). The overload rate represents an acceptable load amount that exceeds rated load, and is expressed in a ratio based on the rated load and the duration. The overload capacity on the S100 series inverter is 150%/1min for heavy loads, and 120%/1min for normal loads.
- The current rating differs from the load rating, as it also has an ambient temperature limit. For derating specifications, refer to [11.8 Continuous Rated Current Derating](#) on page 359.
- Current rating for ambient temperature at normal load operation.

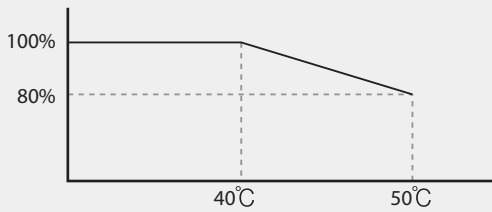

[Ambient temperature versus current rating at normal load]

- Guaranteed carrier frequency for current rating by load.

Inverter capacity	Normal load	Heavy load
0.4–22kW	2kHz	6kHz

5.17 2nd Motor Operation

The 2nd motor operation is used when a single inverter switch operates two motors. Using the 2nd motor operation, a parameter for the 2nd motor is set. The 2nd motor is operated when a multi-function terminal input defined as a 2nd motor function is turned on.

Group	Code	Name	LCD Display	Parameter Setting		Setting Range	Unit
In	65- 71	Px terminal configuration	Px Define(Px: P1–P7)	26	2nd Motor	-	-

2nd Motor Operation Setting Details

Code	Description
In.65–71 Px Define	Set one of the the multi-function input terminals (P1–P5) to 26 (2 nd Motor) to display M2 (2 nd motor group) group. An input signal to a multi-function terminal set to 2 nd motor will operate the motor according to the code settings listed below. However, if the inverter is in operation, input signals to the multi-function terminals will not read as a 2 nd motor parameter. Pr.50 (Stall Prevent) must be set first, before M2.28 (M2-Stall Lev) settings can be used. Also, Pr.40 (ETH Trip Sel) must be set first, before M2.29 (M2-ETH 1min) and M2.30 (M2.ETH Cont) settings.

Parameter Setting at Multi-function Terminal Input on a 2nd Motor

Code	Description	Code	Description
M2.04 Acc Time	Acceleration time	M2.16 Inertia Rt	Load inertia rate
M2.05 Dec Time	Deceleration time	M2.17 Rs	Stator resistance
M2.06 Capacity	Motor capacity	M2.18 Lsigma	Leakage inductance
M2.07 Base Freq	Motor base frequency	M2.19 Ls	Stator inductance

Code	Description	Code	Description
M2.08 Ctrl Mode	Control mode	M2.20 Tr	Rotor time constant
M2.10 Pole Num	Pole number	M2.25 V/F Patt	V/F pattern
M2.11 Rate Slip	Rated slip	M2.26 Fwd Boost	Forward torque boost
M2.12 Rated Curr	Rated current	M2.27 Rev Boost	Reverse torque boost
M2.13 Noload Curr	No-load current	M2.28 Stall Lev	Stall prevention level
M2.14 Rated Volt	Motor rated voltage	M2.29 ETH 1min	Motor heat protection 1min rating
M2.15 Efficiency	Motor efficiency	M2.30 ETH Cont	Motor heat protection continuous rating

Example - 2nd Motor Operation

Use the 2nd motor operation when switching operation between a 7.5kW motor and a secondary 3.7kW motor connected to terminal P3. Refer to the following settings.

Group	Code	Name	LCD Display	Parameter Setting	Setting Range	Unit
In	67	Terminal P3 configuration	P3 Define	26	2nd Motor	-
M2	06	Motor capacity	M2-Capacity	-	3.7kW	-
	08	Control mode	M2-Ctrl Mode	0	V/F	-

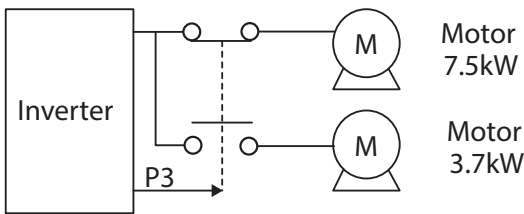

5.18 Supply Power Transition

Supply power transition is used to switch the power source for the motor connected to the inverter from the inverter output power to the main supply power source (commercial power source), or vice versa.

Group	Code	Name	LCD Display	Parameter Setting	Setting Range	Unit
In	65-71	Px terminal configuration	Px Define(Px: P1-P7)	16	Exchange	-
OU	31	Multi-function relay1 items	Relay1	17	Inverter Line	-
	33	Multi-function output1 items	Q1 Define	18	Comm Line	-

Supply Power Transition Setting Details

Code	Description
In.65-71 Px Define	When the motor power source changes from inverter output to main supply power, select a terminal to use and set the code value to 16 (Exchange). Power will be switched when the selected terminal is on. To reverse the transition, switch off the terminal.
OU.31 Realy 1 Define, OU.33 Q1 Define	<p>Set multi-function relay or multi-function output to 17 (Inverter Line) or 18 (COMM line). Relay operation sequence is as follows.</p>

5.19 Cooling Fan Control

This function turns the inverter’s heat-sink cooling fan on and off. It is used in situations where the load stops and starts frequently, or noise free environment is required. The correct use of cooling fan control can extend the cooling fan’s life.

Group	Code	Name	LCD Display	Parameter Setting	Setting Range	Unit
Ad	64	Cooling fan control	FAN Control	0 During Run	0-2	-

Cooling Fan Control Detail Settings

Code	Description		
Ad.64 Fan Control	Settings		
	Description		
	0	During Run	Cooling fan runs when the power is supplied to the inverter and the operation command is on. The cooling fan stops when the power is supplied to the inverter and the operation command is off. When the inverter heat sink temperature is higher than its set value, the cooling fan operates automatically regardless of its operation status.
	1	Always On	Cooling fan runs constantly if the power is supplied to the inverter.
2	Temp Control	With power connected and the run operation command on, if the setting is in Temp Control, the cooling fan will not operate unless the temperature in the heat sink reaches the set temperature.	

Note

Despite setting Ad.64 to 0(During Run), if the heat sink temperature reaches a set level by current input harmonic wave or noise, the cooling fan may run as a protection function.

5.20 Input Power Frequency and Voltage Settings

Select the frequency for inverter input power. If the frequency changes from 60Hz to 50Hz, all other frequency (or RPM) settings including the maximum frequency, base frequency etc., will change to 50Hz. Likewise, changing the input power frequency setting from 50Hz to 60Hz will change all related function item settings from 50Hz to 60Hz.

Group	Code	Name	LCD Display	Parameter Setting		Setting Range	Unit
bA	10	Input power frequency	60/50 Hz Sel	0	60Hz	0-1	-

Set Inverter input power voltage at bA.19. Low voltage fault trip level changes automatically to the set voltage standard.

Group	Code	Name	LCD Display	Parameter Setting		Setting Range	Unit
bA	19	Input power voltage	AC Input Volt	220V	220	170-240	V
				400V	380	320-480	

5.21 Read, Write, and Save Parameters

Use read, write and save function parameters on the inverter to copy parameters from the inverter to the keypad or from the keypad to the inverter.

Group	Code	Name	LCD Display	Parameter Setting		Setting Range	Unit
CNF*	46	Parameter read	Parameter Read	1	Yes	-	-
	47	Parameter write	Parameter Write	1	Yes	-	-
	48	Parameter save	Parameter Save	1	Yes	-	-

*Available on LCD keypad only.

Read, Write, and Save Parameter Setting Details

Code	Description
CNF-46 Parameter Read	Copies saved parameters from the inverter to the keypad. Saved parameters on the keypad will be deleted and replaced with copied parameters.
CNF-47 Parameter Write	Copies saved parameters from the keypad to the inverter. Saved parameters on the inverter will be deleted and replaced with copied parameters. If an error occurs during parameter writing, previous saved data will be used. If there is no saved data on the Keypad, 'EEP Rom Empty' message will be displayed.
CNF-48 Parameter Save	As parameters set during communication transmission are saved to RAM, the setting values will be lost if the power goes off and on. When setting parameters during communication transmission, select 1 (Yes) from CNF-48 code to save the set parameter.

5.22 Parameter Initialization

User changes to parameters can be initialized (reset) to factory default settings on all or selected groups. However, during a fault trip situation or operation, parameters cannot be initialized.

Group	Code	Name	LCD Display	Parameter Setting		Setting Range	Unit
dr*	93	Parameter initialization	-	0	No	0-16	
CNF**	40	Parameter initialization	Parameter Init	0	No	0-16	

* For keypad

** For LCD keypad

Parameter Initialization Setting Details

Code		Description		
dr.93, CNF-40 Parameter Init	Setting		LCD Display	Function
	0	No	No	-
	1	Initialize all groups	All Grp	Initialize all data. Select 1(All Grp) and press [PROG/ENT] key to start initialization. On completion, 0(No) will be displayed.
	2	Initialize dr group	DRV Grp	Initialize data by groups. Select initialize group and press [PROG/ENT] key to start initialization. On completion, 0(No) will be displayed.
	3	Initialize bA group	BAS Grp	
	4	Initialize Ad group	ADV Grp	
	5	Initialize Cn group	CON Grp	
	6	Initialize In group	IN Grp	
	7	Initialize OU group	OUT Grp	
	8	Initialize CM group	COM Grp	
	9	Initialize AP group	APP Grp	
	12	Initialize Pr group	PRT Grp	
	13	Initialize M2 group	M2 Grp	
16	Initialize OperationGroup	SPS Grp		

5.23 Parameter View Lock

Use parameter view lock to hide parameters after registering and entering a user password.

Group	Code	Name	LCD Display	Parameter Setting	Setting Range	Unit
CNF*	50	Parameter view lock	View Lock Set	Unlocked	0-9999	
	51	Parameter view lock password	View Lock Pw	Password	0-9999	

* Available on LCD keypad only.

Parameter View Lock Setting Details

Code	Description
CNF-51 View Lock Pw	Register a password to allow access to parameter view lock. Follow the steps below to register a password.

Code	Description	
	No	Procedure
	1	[PROG/ENT] key on CNF-51 code will show the previous password input window. If registration is made for the first time, enter 0. It is the factory default.
	2	If a password had been set, enter the saved password.
	3	If the entered password matches the saved password, a new window prompting the user to enter a new password will be displayed (the process will not progress to the next stage until the user enters a valid password).
	4	Register a new password.
	5	After registration, code CNF-51 will be displayed.
CNF-50 View Lock Set	To enable parameter view lock, enter a registered password. [Locked] sign will be displayed on the screen to indicate that parameter view lock is enabled. To disable parameter view lock, re-enter the password. The [locked] sign will disappear.	

5.24 Parameter Lock

Use parameter lock to prevent unauthorized modification of parameter settings. To enable parameter lock, register and enter a user password first.

Group	Code	Name	LCD Display	Parameter Setting	Setting Range	Unit
dr	94	Password registration	-	-	0-9999	-
	95	Parameter lock password	-	-	0-9999	-
CNF*	52	Parameter lock	Key Lock Set	Unlocked	0-9999	-
	53	Parameter lock password	Key Lock PW	Password	0-9999	-

*Available on LCD keypad only.

Parameter Lock Setting Details

Code	Description	
CNF-53 Key Lock Pw	Register a password to prohibit parameter modifications. Follow the procedures below to register a password.	
	No	Procedures
	1	Press the [PROG/ENT] key on CNF-53 code and the saved password input window will be displayed. If password registration is being made for the first time, enter 0. It is the factory default.
	2	If a saved password has been set, enter the saved password.

Code	Description	
	3	If the entered password matches the saved password, then a new window to enter a new password will be displayed. (The process will not move to next stage until the user enters a valid password).
	4	Register a new password.
	5	After registration, Code CNF-51 will be displayed.
CNF-52 Key Lock Set	To enable parameter lock, enter the registered password. [Locked] sign will be displayed on the screen to indicate that prohibition is enabled. Once enabled, Pressing the [PROG/ENT] key on function code will not allow the display edit mode to run. To disable parameter modification prohibition, re-enter the password. The [Locked] sign will disappear.	

 **Caution**

If parameter view lock and parameter lock functions are enabled, no inverter operation related function changes can be made. It is very important that you memorize the password.

5.25 Changed Parameter Display

This feature displays all the parameters that are different from the factory defaults. Use this feature to track changed parameters.

Group	Code	Name	LCD Display	Parameter Setting	Setting Range	Unit
CNF*	41	Changed parameter display	Changed Para	0 View All	-	-

* Available on LCD keypad only.

Changed Parameter Display Setting Details

Code	Description		
CNF-41 Changed Para	Setting	Function	
	0	View All	Display all parameters
	1	View Changed	Display changed parameters only





5.26 User Group

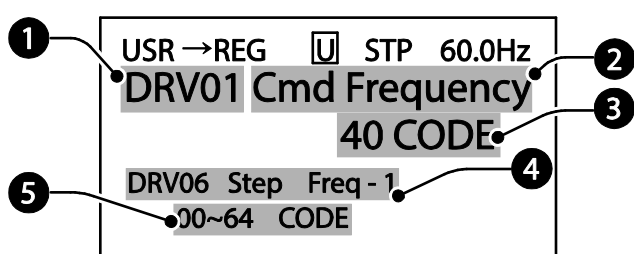

Create a user defined group and register user-selected parameters from the existing function groups. The user group can carry up to a maximum of 64 parameter registrations.

Group	Code	Name	LCD Display	Parameter Setting	Setting Range	Unit
CNF*	42	Multi-function key settings	Multi Key Sel	3	UserGrp SelKey	-
	45	Delete all user registered codes	UserGrp AllDel	0	No	-

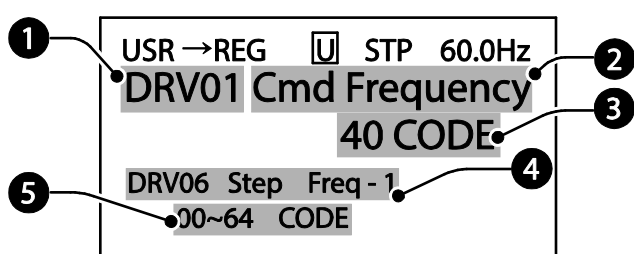
* Available on LCD keypad only.

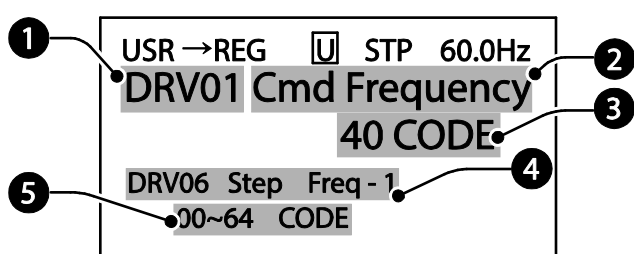
User Group Setting Details

Code	Description										
CNF-42 Multi-Key Sel	<p>Select 3(UserGrp SelKey) from the multi-function key setting options. If user group parameters are not registered, setting the multi-function key to the user group select key (UserGrp SelKey) will not display user group (USR Grp) item on the Keypad.</p> <p>Follow the procedures below to register parameters to a user group.</p> <table border="1"> <thead> <tr> <th>No</th> <th>Procedure</th> </tr> </thead> <tbody> <tr> <td>1</td> <td>Set CNF- 42 to 3(UserGrp SelKey). A  icon will be displayed at the top of the LCD display.</td> </tr> <tr> <td>2</td> <td>In the parameter mode (PAR Mode), move to the parameter you need to register and press the [MULTI] key. For example, if the [MULTI] key is pressed in the frequency reference in DRV 01 (Cmd Frequency), the screen below will be displayed. <div style="text-align: center;">  </div> <ul style="list-style-type: none"> ① Group name and code number of the parameter ② Name of the parameter ③ Code number to be used in the user group. Pressing the [PROG/ENT] key on the code number (40 Code) will register DRV-01 as code 40 in the user group. ④ Existing parameter registered as the user group code 40 ⑤ Setting range of the user group code. Entering 0 cancels the settings. </td> </tr> <tr> <td>3</td> <td>Set a code number (③) to use to register the parameter in the user group. Select code number and press [PROG/ENT] key.</td> </tr> <tr> <td>4</td> <td>Changing the value in ③ will also change the value in ④. If no</td> </tr> </tbody> </table>	No	Procedure	1	Set CNF- 42 to 3(UserGrp SelKey). A  icon will be displayed at the top of the LCD display.	2	In the parameter mode (PAR Mode), move to the parameter you need to register and press the [MULTI] key. For example, if the [MULTI] key is pressed in the frequency reference in DRV 01 (Cmd Frequency), the screen below will be displayed. <div style="text-align: center;">  </div> <ul style="list-style-type: none"> ① Group name and code number of the parameter ② Name of the parameter ③ Code number to be used in the user group. Pressing the [PROG/ENT] key on the code number (40 Code) will register DRV-01 as code 40 in the user group. ④ Existing parameter registered as the user group code 40 ⑤ Setting range of the user group code. Entering 0 cancels the settings. 	3	Set a code number (③) to use to register the parameter in the user group. Select code number and press [PROG/ENT] key.	4	Changing the value in ③ will also change the value in ④. If no
	No	Procedure									
	1	Set CNF- 42 to 3(UserGrp SelKey). A  icon will be displayed at the top of the LCD display.									
	2	In the parameter mode (PAR Mode), move to the parameter you need to register and press the [MULTI] key. For example, if the [MULTI] key is pressed in the frequency reference in DRV 01 (Cmd Frequency), the screen below will be displayed. <div style="text-align: center;">  </div> <ul style="list-style-type: none"> ① Group name and code number of the parameter ② Name of the parameter ③ Code number to be used in the user group. Pressing the [PROG/ENT] key on the code number (40 Code) will register DRV-01 as code 40 in the user group. ④ Existing parameter registered as the user group code 40 ⑤ Setting range of the user group code. Entering 0 cancels the settings. 									
	3	Set a code number (③) to use to register the parameter in the user group. Select code number and press [PROG/ENT] key.									
4	Changing the value in ③ will also change the value in ④. If no										

Code	Description												
	code is registered, 'Empty Code' will be displayed. Entering 0 cancels the settings.												
5	The registered parameters are listed in the user group in U&M mode. You can register one parameter multiple times if necessary. For example, a parameter can be registered as code 2, code 11, and more in the user group.												
Follow the procedures below to delete parameters in the user group.													
	<table border="1"> <thead> <tr> <th>No.</th> <th>Settings</th> </tr> </thead> <tbody> <tr> <td>1</td> <td>Set CNF- 42 to 3(UserGrp SelKey). A  icon will be displayed at the top of the LCD display.</td> </tr> <tr> <td>2</td> <td>In the USR group in U&M mode, move the cursor to the code that is to be deleted.</td> </tr> <tr> <td>3</td> <td>Press the [MULTI] key.</td> </tr> <tr> <td>4</td> <td>Move to YES on the deletion confirmation screen, and press the [PROG/ENT] key.</td> </tr> <tr> <td>5</td> <td>Deletion completed.</td> </tr> </tbody> </table>	No.	Settings	1	Set CNF- 42 to 3(UserGrp SelKey). A  icon will be displayed at the top of the LCD display.	2	In the USR group in U&M mode, move the cursor to the code that is to be deleted.	3	Press the [MULTI] key.	4	Move to YES on the deletion confirmation screen, and press the [PROG/ENT] key.	5	Deletion completed.
No.	Settings												
1	Set CNF- 42 to 3(UserGrp SelKey). A  icon will be displayed at the top of the LCD display.												
2	In the USR group in U&M mode, move the cursor to the code that is to be deleted.												
3	Press the [MULTI] key.												
4	Move to YES on the deletion confirmation screen, and press the [PROG/ENT] key.												
5	Deletion completed.												
CNF-25 UserGrp AllDel	Set to 1(Yes) to delete all registered parameters in the user group.												

5.27 Easy Start On

Run Easy Start On to easily setup the basic motor parameters required to operate a motor in a batch. Set CNF-61(Easy Start On) to 1(Yes) to activate the feature, initialize all parameters by setting CNF-40 (Parameter Init) to 1 (All Grp), and restart the inverter to activate Easy Start On.

Group	Code	Name	LCD Display	Parameter Setting	Setting Range	Unit
CNF*	61	Parameter easy start settings	Easy Start On	1	Yes	-

*Available on LCD keypad only.

Easy Start On Setting Details

Code	Description								
CNF-61 Easy Start On	Follow the procedures listed below to set parameter easy start.								
	<table border="1"> <thead> <tr> <th>No</th> <th>Procedures</th> </tr> </thead> <tbody> <tr> <td>1</td> <td>Set CNF-61 (Easy Start On) to 1(Yes).</td> </tr> <tr> <td>2</td> <td>Select 1(All Grp) in CNF-40 (Parameter Init) to initialize all parameters in the inverter.</td> </tr> <tr> <td>3</td> <td>Restarting the inverter will activate the Easy Start On. Set the values in the following screens on the LCD keypad. To escape from the Easy Start On, press the [ESC] key.</td> </tr> </tbody> </table>	No	Procedures	1	Set CNF-61 (Easy Start On) to 1(Yes).	2	Select 1(All Grp) in CNF-40 (Parameter Init) to initialize all parameters in the inverter.	3	Restarting the inverter will activate the Easy Start On. Set the values in the following screens on the LCD keypad. To escape from the Easy Start On, press the [ESC] key.
	No	Procedures							
	1	Set CNF-61 (Easy Start On) to 1(Yes).							
2	Select 1(All Grp) in CNF-40 (Parameter Init) to initialize all parameters in the inverter.								
3	Restarting the inverter will activate the Easy Start On. Set the values in the following screens on the LCD keypad. To escape from the Easy Start On, press the [ESC] key.								

Code	Description
	<ul style="list-style-type: none"> • Start Easy Set: Select Yes. • DRV-14 Motor Capacity: Set motor capacity. • BAS-11 Pole Number: Set motor pole number. • BAS-15 Rated Volt: Set motor rated voltage. • BAS-10 60/50Hz Sel: Set motor rated frequency. • BAS-19 AC Input Volt: Set input voltage. • DRV-06 Cmd Source: Set command source. • DRV-01 Cmd Frequency: Set operation frequency. <p>When the settings are completed, the minimum parameter setting on the motor has been made. The LCD keypad will return to a monitoring display. Now the motor can be operated with the command source set at DRV-06.</p>

5.28 Config(CNF) Mode

The config mode parameters are used to configure the LCD keypad related features.

Group	Code	Name	LCD Display	Parameter Setting	Setting Range	Unit
CNF*	2	LCD brightness/contrast adjustment	LCD Contrast	-	-	
	10	Inverter S/W version	Inv S/W Ver	x.xx	-	
	11	Keypad S/W version	Keypad S/W Ver	x.xx	-	-
	12	Keypad title version	KPD Title Ver	x.xx	-	-
	30-32	Power slot type	Option-x Type	None	-	-
	44	Erase trip history	Erase All Trip	No	-	-
	60	Add title update	Add Title Up	No	-	-
	62	Initialize accumulated electric energy	WH Count Reset	No	-	-

* Available on the LCD keypad only.

Config Mode Parameter Setting Details

Code	Description
CNF-2 LCD contrast	Adjusts LCD brightness/contrast on the LCD keypad.
CNF-10 Inv S/W Ver, CNF-11 Keypad S/W Ver	Check OS version in the inverter and on the LCD keypad.

Code	Description
CNF-12 KPD title Ver	Checks title version on the LCD keypad.
CNF-30–32 Option-x type	Checks type of powerboard installed in 1-3 power slot.
CNF-44 Erase all trip	Deletes stored trip history.
CNF-60 Add Title Up	When inverter SW version is updated and more code is added, CNF-60 settings will add, display, and operate the added codes. Set CNF-60 to 1 (Yes) and disconnect the LCD keypad from the inverter. Reconnecting the LCD keypad to the inverter updates titles.
CNF-62 WH Count Reset	Initialize accumulated electric energy consumption count.

5.29 Timer Settings

Set a multi-function input terminal to a timer and On/Off control the multi-function output and relay according to the timer settings.

Group	Code	Name	LCD Display	Parameter Setting	Setting Range	Unit
In	65–71	Px terminal configuration	Px Define(Px: P1–P7)	38	Timer In	-
OU	31	Multi-function relay1	Relay 1	28	Timer Out	-
	33	Multi-function output1	Q1 Define			
	55	Timer on delay	Timer on delay	3.00	0.00–100	sec
	56	Timer off delay	Timer off delay	1.00	0.00–100	sec

Timer Setting Details

Code	Description
In.65-71 Px Define	Choose one of the multi-function input terminals and change it to a timer terminal by setting it to 38 (Timer In).
OU.31 Relay1, OU.33 Q1 Define	Set multi-function output terminal or relay to be used as a timer to 28 (Timer out).
OU.55 TimerOn Delay, OU.56 TimerOff Delay	Input a signal (On) to the timer terminal to operate a timer output (Timer out) after the time set at OU.55 has passed. When the multi-function input terminal is off, multi-function output or relay turns off after the time set at OU.56.

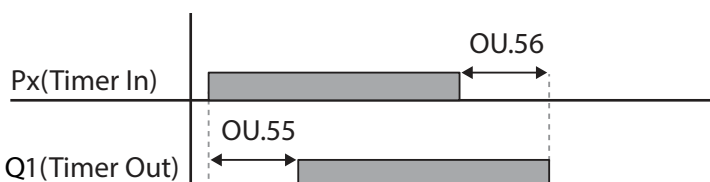

5.30 Brake Control

Brake control is used to control the On/Off operation of electronic brake load system.

Group	Code	Name	LCD Display	Parameter Setting		Setting Range	Unit
dr	09	Control mode	Control Mode	0	V/F	-	-
Ad	41	Brake open current	BR Rls Curr	50.0		0.0–180%	%
	42	Brake open delay time	BR Rls Dly	1.00		0.0–10.0	sec
	44	Brake open forward frequency	BR Rls Fwd Fr	1.00		0–Maximum frequency	Hz
	45	Brake open reverse frequency	BR Rls Rev Fr	1.00		0–Maximum frequency	Hz
	46	Brake close delay time	BR Eng Dly	1.00		0.00–10.00	sec
	47	Brake close frequency	BR Eng Fr	2.00		0–Maximum frequency	Hz
OU	31	Multi-function relay1 item	Relay 1	35	BR Control:	-	-
	33	Multi-function output1 item	Q1 Define				

When brake control is activated, DC braking (Ad.12) at inverter start and dwell operation (Ad.20-23) do not operate.

- Brake release sequence:** During motor stop state, if an operation command is entered, the inverter accelerates up to brake release frequency (Ad.44- 45) in forward or in reverse direction. After reaching brake release frequency, if motor current reaches brake release current (BR Rls Curr), the output relay or multi function output terminal for brake control sends a release signal. Once the signal has been sent, acceleration will begin after maintaining frequency for brake release delay time (BR Rls Dly).
- Brake engage sequence:** If a stop command is sent during operation, the motor decelerates. Once the output frequency reaches brake engage frequency (BR Eng Fr), the motor stops deceleration and sends out a brake engage signal to a preset output terminal. Frequency is maintained for the brake engage delay time (BR Eng Dly) and will become 0 afterwards. If DC braking time (Ad.15) and DC braking resistance (Ad.16) are set, inverter output is blocked after DC braking. For DC braking, refer to [4.17.2 Stop After DC Braking](#) on page [101](#).

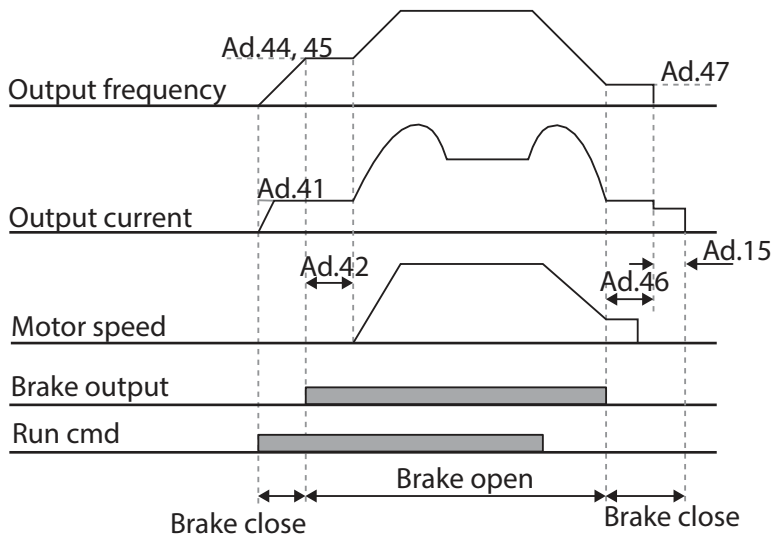

5.31 Multi-Function Output On/Off Control

Set reference values (on/off level) for analog input and control output relay or multi-function output terminal on/off status accordingly.

Group	Code	Name	LCD Display	Parameter Setting	Setting Range	Unit
Ad	66	Output terminal on/off control mode	On/Off Ctrl Src	1 V1	-	-
	67	Output terminal on level	On-C Level	90.00	Output terminal off level- 100.00%	%
	68	Output terminal off level	Off-C Level	10.00	0.00-Output terminal on level	%
OU	31	Multi-function relay1 item	Relay 1	34 On/Off	-	-
	33	Multi-function output1 item	Q1 Define			

Multi-function Output On/Off Control Setting Details

Code	Description
Ad.66 On/Off Ctrl Src	Select analog input On/Off control.
Ad.67 On-C Level , Ad.68 Off-C Level	Set On/Off level at the output terminal.

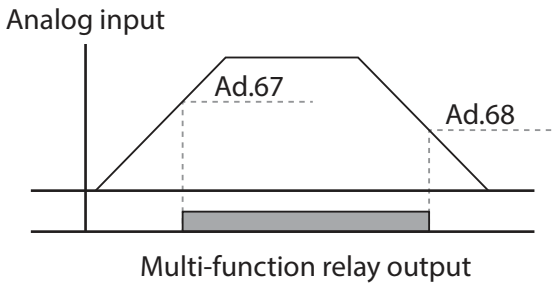

5.32 Press Regeneration Prevention

Press regeneration prevention is used during press operations to prevent braking during the regeneration process. If motor regeneration occurs during a press operation, motor operation speed automatically goes up to avoid the regeneration zone.

Group	Code	Name	LCD Display	Parameter Setting		Setting Range	Unit
Ad	74	Select press regeneration prevention for press	RegenAvd Sel	0	No	0-1	-
	75	Press regeneration prevention operation voltage level	RegenAvd Level	350V		200V: 300-400V	V
				700V		400V: 600-800V	
	76	Press regeneration prevention compensation frequency limit	CompFreq Limit	1.00(Hz)		0.00- 10.00Hz	Hz
	77	Press regeneration prevention P gain	RegenAvd Pgain	50.0(%)		0.0- 100.0%	%
78	Press regeneration prevention I gain	RegenAvd Igain	500(ms)		20-30000ms	ms	

Press Regeneration Prevention Setting Details

Code	Description
Ad.74 RegenAvd Sel	Frequent regeneration voltage from a press load during constant speed motor operation may force excessive work on the brake unit which may damage or shorten the brake life. To prevent this situation, select Ad.74 (RegenAvd Sel) to control DC link voltage and disable the brake unit operation.
Ad.75 RegenAvd Level	Set brake operation prevention level voltage when the DC link voltage goes up due to regeneration.

Code	Description
Ad.76 CompFreq Limit	Set alternative frequency width that can replace actual operation frequency during regeneration prevention.
Ad.77 RegenAvd Pgain, Ad.78 RegenAvd Igain	To prevent regeneration zone, set P gain/I gain in the DC link voltage suppress PI controller.

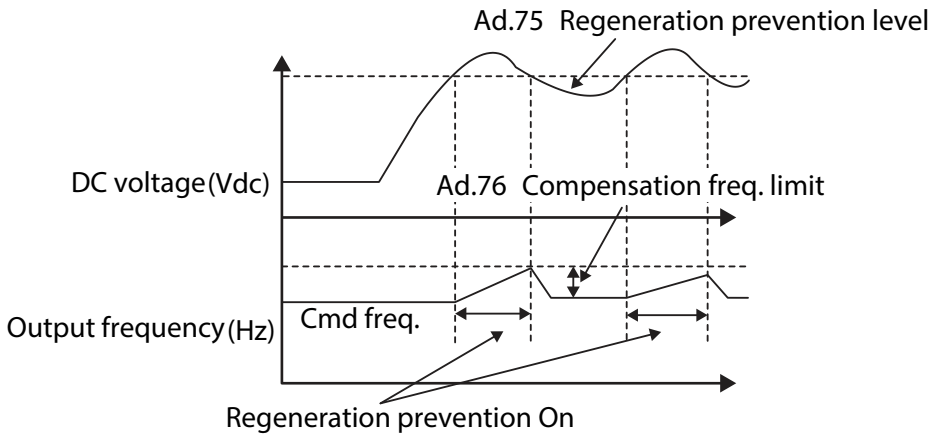

Note

Press regeneration prevention does not operate during accelerations or decelerations, but it only operates during constant speed motor operation. When regeneration prevention is activated, output frequency may change within the range set at Ad.76 (CompFreq Limit).

5.33 Analog Output

An analog output terminal provides output of 0-10V voltage, 4-20mA current, or 0-32kHz pulse.

5.33.1 Voltage and Current Analog Output

An output size can be adjusted by selecting an output option at AO(Analog Output) terminal. Set the analog voltage/current output terminal setting switch (SW3) to change the output type (voltage/current).

Group	Code	Name	LCD Display	Parameter Setting	Setting Range	Unit
OU	01	Analog output1	AO1 Mode	0 Frequency	0-15	-
	02	Analog output1 gain	AO1 Gain	100.0	-1000.0-1000.0	%
	03	Analog output1 bias	AO1 Bias	0.0	-100.0-100.0	%

Group	Code	Name	LCD Display	Parameter Setting	Setting Range	Unit
	04	Analog output1 filter	AO1 Filter	5	0-10000	ms
	05	Analog constant output1	AO1 Const %	0.0	0.0-100.0	%
	06	Analog output1 monitor	AO1 Monitor	0.0	0.0-1000.0	%

Voltage and Current Analog Output Setting Details

Code	Description																								
OU.01 AO1 Mode	Select a constant value for output. The following example for output voltage setting.																								
	<table border="1"> <thead> <tr> <th>Setting</th> <th>Function</th> </tr> </thead> <tbody> <tr> <td>0</td> <td>Frequency Outputs operation frequency as a standard. 10V output is made from the frequency set at dr.20(Max Freq)</td> </tr> <tr> <td>1</td> <td>Output Current 10V output is made from 200% of inverter rated current (heavy load).</td> </tr> <tr> <td>2</td> <td>Output Voltage Sets the outputs based on the inverter output voltage. 10V output is made from a set voltage in bA.15 (Rated V). If 0V is set in bA.15, 200V/400V models output 10V based on the actual input voltages (240V and 480V respectively).</td> </tr> <tr> <td>3</td> <td>DC Link Volt Outputs inverter DC link voltage as a standard. Outputs 10V when the DC link voltage is 410Vdc for 200V models, and 820Vdc for 400V models.</td> </tr> <tr> <td>4</td> <td>Torque Outputs the generated torque as a standard. Outputs 10V at 250% of motor rated torque.</td> </tr> <tr> <td>5</td> <td>Ouput Power Monitors output wattage. 200% of rated output is the maximum display voltage (10V).</td> </tr> <tr> <td>6</td> <td>Idse Outputs the maximum voltage at 200% of no load current.</td> </tr> <tr> <td>7</td> <td>Iqse Outputs the maximum voltage at 250% of rated torque current $= \sqrt{\text{rated current}^2 - \text{no load current}^2}$</td> </tr> <tr> <td>8</td> <td>Target Freq Outputs set frequency as a standard. Outputs 10V at the maximum frequency (dr.20).</td> </tr> <tr> <td>9</td> <td>Ramp Freq Outputs frequency calculated with Acc/Dec function as a standard. May vary with actual output frequency. Outputs 10V.</td> </tr> <tr> <td>12</td> <td>PID Ref Value Outputs command value of a PID controller as a</td> </tr> </tbody> </table>	Setting	Function	0	Frequency Outputs operation frequency as a standard. 10V output is made from the frequency set at dr.20(Max Freq)	1	Output Current 10V output is made from 200% of inverter rated current (heavy load).	2	Output Voltage Sets the outputs based on the inverter output voltage. 10V output is made from a set voltage in bA.15 (Rated V). If 0V is set in bA.15, 200V/400V models output 10V based on the actual input voltages (240V and 480V respectively).	3	DC Link Volt Outputs inverter DC link voltage as a standard. Outputs 10V when the DC link voltage is 410Vdc for 200V models, and 820Vdc for 400V models.	4	Torque Outputs the generated torque as a standard. Outputs 10V at 250% of motor rated torque.	5	Ouput Power Monitors output wattage. 200% of rated output is the maximum display voltage (10V).	6	Idse Outputs the maximum voltage at 200% of no load current.	7	Iqse Outputs the maximum voltage at 250% of rated torque current $= \sqrt{\text{rated current}^2 - \text{no load current}^2}$	8	Target Freq Outputs set frequency as a standard. Outputs 10V at the maximum frequency (dr.20).	9	Ramp Freq Outputs frequency calculated with Acc/Dec function as a standard. May vary with actual output frequency. Outputs 10V.	12	PID Ref Value Outputs command value of a PID controller as a
	Setting	Function																							
	0	Frequency Outputs operation frequency as a standard. 10V output is made from the frequency set at dr.20(Max Freq)																							
	1	Output Current 10V output is made from 200% of inverter rated current (heavy load).																							
	2	Output Voltage Sets the outputs based on the inverter output voltage. 10V output is made from a set voltage in bA.15 (Rated V). If 0V is set in bA.15, 200V/400V models output 10V based on the actual input voltages (240V and 480V respectively).																							
	3	DC Link Volt Outputs inverter DC link voltage as a standard. Outputs 10V when the DC link voltage is 410Vdc for 200V models, and 820Vdc for 400V models.																							
	4	Torque Outputs the generated torque as a standard. Outputs 10V at 250% of motor rated torque.																							
	5	Ouput Power Monitors output wattage. 200% of rated output is the maximum display voltage (10V).																							
	6	Idse Outputs the maximum voltage at 200% of no load current.																							
	7	Iqse Outputs the maximum voltage at 250% of rated torque current $= \sqrt{\text{rated current}^2 - \text{no load current}^2}$																							
8	Target Freq Outputs set frequency as a standard. Outputs 10V at the maximum frequency (dr.20).																								
9	Ramp Freq Outputs frequency calculated with Acc/Dec function as a standard. May vary with actual output frequency. Outputs 10V.																								
12	PID Ref Value Outputs command value of a PID controller as a																								

Code	Description	
		standard. Outputs approximately 6.6V at 100%.
13	PID Fdk Value	Outputs feedback volume of a PID controller as a standard. Outputs approximately 6.6V at 100%.
14	PID Output	Outputs output value of a PID controller as a standard. Outputs approximately 10V at 100%.
15	Constant	Outputs OU.05 (AO1 Const %) value as a standard.

Adjusts output value and offset. If frequency is selected as an output item, it will operate as shown below.

$$AO1 = \frac{Frequency}{MaxFreq} \times AO1 Gain + AO1 Bias$$

The graph below illustrates the analog voltage output (AO1) changes depend on OU.02 (AO1 Gain) and OU.3 (AO1 Bias) values. Y-axis is analog output voltage (0-10V), and X-axis is % value of the output item.

Example, if the maximum frequency set at dr.20 (Max Freq) is 60Hz and the present output frequency is 30Hz, then the x-axis value on the next graph is 50%.

OU.02 AO1 Gain,
OU.03 AO1 Bias

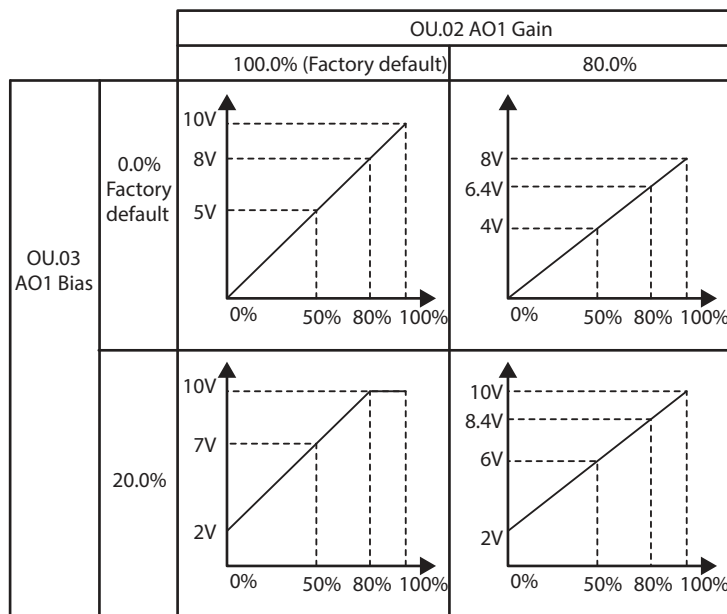

OU.04 AO1 Filter	Set filter time constant on analog output.
OU.05 AO1 Const %	If analog output at OU.01 (AO1 Mode) is set to 15(Constant), the analog voltage output is dependent on the set parameter values (0-100%).
OU.06 AO1 Monitor	Monitors analog output value. Displays the maximum output voltage as a percentage (%) with 10V as the standard.

5.33.2 Analog Pulse Output

Output item selection and pulse size adjustment can be made for the TO (Pulse Output) terminal.

Group	Code	Name	LCD Display	Parameter Setting		Setting Range	Unit
OU	33	Multi-function output 1	Q1 define	38	TO	0-38	-
	61	Pulse output setting	TO Mode	0	Frequency	0-15	-
	62	Pulse output gain	TO Gain	100.0		-1000.0-1000.0	%
	63	Pulse output bias	TO Bias	0.0		-100.0-100.0	%
	64	Pulse output filter	TO Filter	5		0-10000	ms
	65	Pulse output constant output2	TO Const %	0.0		0.0-100.0	%
	66	Pulse output monitor	TO Monitor	0.0		0.0-1000.0	%

Analog Pulse Output Setting Details

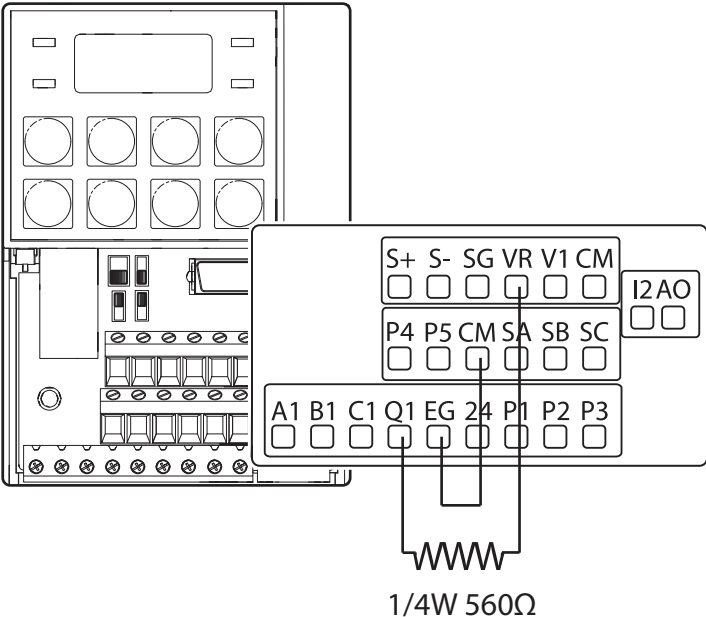
Code	Description
OU.33 Q1 Define	<p>In case of Standard I/O, pulse output TO and multi-function output Q1 share the same terminal. Set OU.33 to 32kHz pulse output and follow the instructions below to make wiring connections that configure the open collector output circuit.</p> <ol style="list-style-type: none"> 1. Connect a 1/4W, 560Ω resistor between VR and Q1 terminals. 2. Connect EG and CM terminals. <p>When wiring the resistor, a resistance of 560Ω or less is recommended to stably provide 32kHz pulse output.</p>  <p>The diagram shows a terminal block with the following labels: S+, S-, SG, VR, V1, CM, P4, P5, CM, SA, SB, SC, A1, B1, C1, Q1, EG, 24, P1, P2, P3, and I2 AO. A resistor is connected between VR and Q1, and another wire connects EG and CM.</p>
OU.62 TO Gain, OU.63 TO Bias	<p>Adjusts output value and offset. If frequency is selected as an output, it will operate as shown below.</p> $TO = \frac{Frequency}{MaxFreq} \times TO\ Gain + TO\ Bias$ <p>The following graph illustrates that the pulse output (TO) changes depend on OU.62 (TO Gain) and OU.63 (TO Bias) values. The Y-axis is an analog output current(0-32kHz), and X-axis is % value on output item.</p> <p>For example, if the maximum frequency set with dr.20 (Max Freq) is 60Hz and present output frequency is 30Hz, then the x-axis value on the next graph is 50%.</p>

Code	Description															
	<table border="1" style="width: 100%; border-collapse: collapse;"> <thead> <tr> <th colspan="2"></th> <th colspan="2" style="text-align: center;">OU.62 TO Gain</th> </tr> <tr> <th colspan="2"></th> <th style="text-align: center;">100.0% (Factory default)</th> <th style="text-align: center;">80.0%</th> </tr> </thead> <tbody> <tr> <td rowspan="2" style="text-align: center; vertical-align: middle;">OU.63 TO Bias</td> <td style="text-align: center; vertical-align: middle;">0.0% Factory default</td> <td style="text-align: center;"> </td> <td style="text-align: center;"> </td> </tr> <tr> <td style="text-align: center; vertical-align: middle;">20.0%</td> <td style="text-align: center;"> </td> <td style="text-align: center;"> </td> </tr> </tbody> </table>			OU.62 TO Gain				100.0% (Factory default)	80.0%	OU.63 TO Bias	0.0% Factory default			20.0%		
		OU.62 TO Gain														
		100.0% (Factory default)	80.0%													
OU.63 TO Bias	0.0% Factory default															
	20.0%															
OU.64 TO Filter	Sets filter time constant on analog output.															
OU.65 TO Const %	If analog output item is set to constant, the analog pulse output is dependent on the set parameter values.															
OU.66 TO Monitor	Monitors analog output value. Displays the maximum output pulse (32kHz) as a percentage (%) of the standard.															

Note

OU.08 AO2 Gain and OU.09 AO2 Bias Tuning Mode on 4-20mA output

- 1 Set OU.07 (AO2 Mode) to constant, and set OU.11 (AO2 Const %) to 0.0 %.
- 2 Set OU.09 (AO2 Bias) to 20.0% and then check current output. 4mA output should be displayed.
- 3 If the value is less than 4mA, gradually increase OU.09 (AO2 Bias) until 4mA is measured. If the value is more than 4mA, gradually decrease OU.09 (AO2 Bias) until 4mA is measured.
- 4 Set OU.11 AO2 Const % to 100.0%
Set OU.08 (AO2 Gain) to 80.0% and measure current output at 20mA. If the value is less than 20mA, gradually increase OU.08 (AO2 Gain) until 20mA is measured. If the value is more than 20mA, gradually decrease OU.08 (AO2 Gain) until 20mA is measured.

The functions for each code are identical to the descriptions for the 0-10V voltage outputs with an output range 4-20mA.

5.34 Digital Output

5.34.1 Multi-function Output Terminal and Relay Settings

Group	Code	Name	LCD Display	Parameter Setting	Setting Range	Unit
OU	30	Fault output item	Trip Out Mode	010*	-	bit
	31	Multi-function relay1 setting	Relay 1	29 Trip	-	-
	33	Multi-function output1 setting	Q1 Define	14 Run	-	-
	41	Multi-function output monitor	DO Status	-	00- 11	bit
	57	Detection frequency	FDT Frequency	30.00	0.00-Maximum frequency	Hz
58	Detection frequency band	FDT Band	10.00			
In	65-71	Px terminal configuration	Px Define	16 Exchange	-	-

*Displayed as  on the keypad.

Multi-function Output Terminal and Relay Setting Details

Code	Description						
OU.31 Relay1	Set relay (Relay 1) output options.						
OU.33 Q1 Define	Select output options for multi-function output terminal (Q1). Q1 is open collector TR output.						
OU.41 DO Status	Set output terminal and relay functions according to OU.57 FDT (Frequency), OU.58 (FDT Band) settings and fault trip conditions.						
	<table border="1"> <thead> <tr> <th>Setting</th> <th>Function</th> </tr> </thead> <tbody> <tr> <td>0 None</td> <td>No output signal.</td> </tr> <tr> <td>1 FDT-1</td> <td> Detects inverter output frequency reaching the user set frequency. Outputs a signal when the absolute value (set frequency-output frequency) < detected frequency width/2. When detected frequency width is 10Hz, FDT-1 output is as shown in the graph below. </td> </tr> </tbody> </table>	Setting	Function	0 None	No output signal.	1 FDT-1	Detects inverter output frequency reaching the user set frequency. Outputs a signal when the absolute value (set frequency-output frequency) < detected frequency width/2. When detected frequency width is 10Hz, FDT-1 output is as shown in the graph below.
	Setting	Function					
0 None	No output signal.						
1 FDT-1	Detects inverter output frequency reaching the user set frequency. Outputs a signal when the absolute value (set frequency-output frequency) < detected frequency width/2. When detected frequency width is 10Hz, FDT-1 output is as shown in the graph below.						

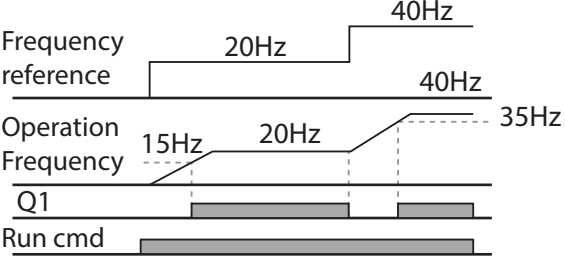
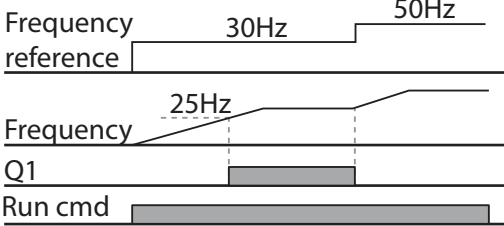
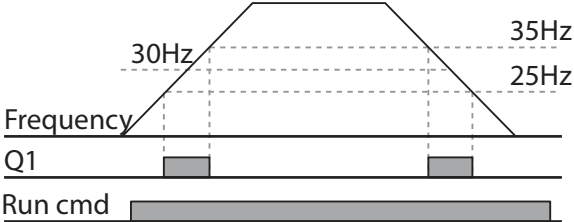
Code	Description	
		 <p>Frequency reference: 20Hz, 40Hz</p> <p>Operation Frequency: 15Hz, 20Hz, 35Hz</p> <p>Q1</p> <p>Run cmd</p>
2	FDT-2	<p>Outputs a signal when the user set frequency and detected frequency (FDT Frequency) are equal, and fulfills FDT-1 condition at the same time.</p> <p>$[\text{Absolute value (set frequency - detected frequency)} < \text{detected frequency width}/2] \& [\text{FDT-1}]$</p> <p>Detected frequency width is 10Hz. When the detected frequency is set to 30Hz, FDT-2 output is as shown in the graph below.</p>  <p>Frequency reference: 30Hz, 50Hz</p> <p>Frequency: 25Hz, 30Hz, 35Hz</p> <p>Q1</p> <p>Run cmd</p>
3	FDT-3	<p>Outputs a signal when the Absolute value (output frequency - operation frequency) < detected frequency width/2.</p> <p>Detected frequency width is 10Hz. When detected frequency is set to 30Hz, FDT-3 output is as shown in the graph below.</p>  <p>Frequency: 30Hz, 35Hz, 25Hz</p> <p>Q1</p> <p>Run cmd</p>
4	FDT-4	<p>Output signal can be separately set for acceleration and deceleration conditions.</p>

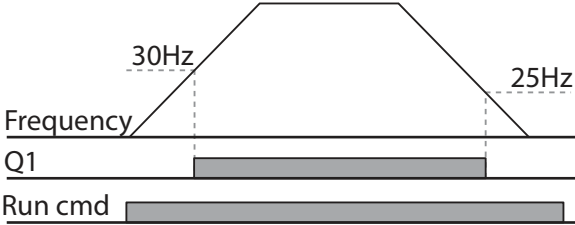
Code	Description	
		<ul style="list-style-type: none"> • In acceleration: Operation frequency \geq Detected frequency • In deceleration: Operation frequency $>$ (Detected frequency - Detected frequency width / 2) <p>Detected frequency width is 10Hz. When detected frequency is set to 30Hz, FDT-4 output is as shown in the graph below.</p> 
5	Overload	Outputs a signal at motor overload.
6	IOL	Outputs a signal when a fault is triggered from a protective function operation by inverter overload inverse proportion.
7	Underload	Outputs a signal at load fault warning.
8	Fan Warning	Outputs a signal at fan fault warning.
9	Stall	Outputs a signal when a motor is overloaded and stalled.
10	Over voltage	Outputs a signal when the inverter DC link voltage rises above the protective operation voltage.
11	Low Voltage	Outputs a signal when the inverter DC link voltage drops below the low voltage protective level.
12	Over Heat	Outputs signal when the inverter overheats.
13	Lost command	<p>Outputs a signal when there is a loss of analog input terminal and RS-485 communication command at the terminal block.</p> <p>Outputs a signal when communication power and expansion an I/O power card is installed, and also outputs a signal when losing analog input and communication power commands.</p>
14	RUN	<p>Outputs a signal when operation command is entered and the inverter outputs voltage.</p> <p>No signal output during DC braking.</p>

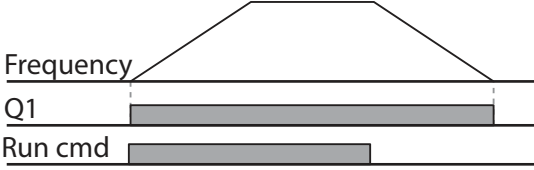











Code	Description	
		 <p>Frequency</p> <p>Q1</p> <p>Run cmd</p>
15	Stop	Outputs a signal at operation command off, and when there is no inverter output voltage.
16	Steady	Outputs a signal in steady operation.
17	Inverter line	Outputs a signal while the motor is driven by the inverter line.
18	Comm line	Outputs a signal while the motor is driven by a commercial power source. For details, refer to 5.18 Supply Power Transition on page 167 .
19	Speed search	Outputs a signal during inverter speed search operation. For details, refer to 5.14 Speed Search Operation on page 159 .
22	Ready	Outputs signal when the inverter is in stand by operation and ready to receive an external operation command.
28	Timer Out	A timer function to operate terminal output after a certain time by using multi-function terminal block input. For more details, refer to 5.29 Timer Settings on page 177 .
29	Trip	Outputs a signal after a fault trip Refer to 5.31 Multi-Function Output On/Off Control on page 179 .
31	DB Warn %ED	Refer to 6.2.5 Dynamic Braking (DB) Resistor Configuration on page 208 .
34	On/Off Control	Outputs a signal using an analog input value as a standard. Refer to 5.31 Multi-Function Output On/Off Control on page 179 .
35	BR Control	Outputs a brake release signal. Refer to 5.30 Brake Control on page 178 .

5.34.2 Fault Trip Output using Multi-Function Output Terminal and Relay

The inverter can output fault trip state using multi-function output terminal (Q1) and relay (Relay 1).

Group	Code	Name	LCD Display	Parameter Setting		Setting Range	Unit
OU	30	Fault trip output mode	Trip Out Mode	010		-	bit
	31	Multi-function relay1	Relay 1	29	Trip	-	-
	33	Multi-function output1	Q1 Define	14	Run	-	-
	53	Fault trip output on delay	TripOut OnDly	0.00		0.00–100.00	sec
	54	Fault trip output off delay	TripOut OffDly	0.00		0.00–100.00	sec

Fault Trip Output by Multi-function Output Terminal and Relay - Setting Details

Code	Description																		
OU.30 Trip Out Mode	Fault trip relay operates based on the fault trip output settings.																		
	<table border="1"> <thead> <tr> <th>Item</th> <th>bit on</th> <th>bit off</th> </tr> </thead> <tbody> <tr> <td>Keypad</td> <td></td> <td></td> </tr> <tr> <td>LCD keypad</td> <td></td> <td></td> </tr> </tbody> </table>	Item	bit on	bit off	Keypad			LCD keypad											
	Item	bit on	bit off																
	Keypad																		
	LCD keypad																		
Select fault trip output terminal/relay and select 29(Trip Mode) at codes OU. 31, 33. When a fault trip occurs in the inverter, the relevant terminal and relay will operate. Depending on the fault trip type, terminal and relay operation can be configured as shown in the table below.																			
<table border="1"> <thead> <tr> <th colspan="3">Setting</th> <th rowspan="2">Function</th> </tr> <tr> <th>bit3</th> <th>bit2</th> <th>bit1</th> </tr> </thead> <tbody> <tr> <td></td> <td></td> <td>✓</td> <td>Operates when low voltage fault trips occur</td> </tr> <tr> <td></td> <td>✓</td> <td></td> <td>Operates when fault trips other than low voltage occur</td> </tr> <tr> <td>✓</td> <td></td> <td></td> <td>Operates when auto restart fails (Pr. 08-09)</td> </tr> </tbody> </table>	Setting			Function	bit3	bit2	bit1			✓	Operates when low voltage fault trips occur		✓		Operates when fault trips other than low voltage occur	✓			Operates when auto restart fails (Pr. 08-09)
Setting			Function																
bit3	bit2	bit1																	
		✓	Operates when low voltage fault trips occur																
	✓		Operates when fault trips other than low voltage occur																
✓			Operates when auto restart fails (Pr. 08-09)																
OU.31 Relay1	Set relay output (Relay 1).																		
OU.33 Q1 Define	Select output for multi-function output terminal (Q1). Q1 is open collector TR output.																		
OU.53 TripOut On Dly, OU.54 TripOut OffDly	If a fault trip occurs, trip relay or multi-function output operates after the time delay set in OU.53. Terminal is off with the input initialized after the time delay set in OU.53.																		













5.34.3 Multi-function Output Terminal Delay Time Settings

Set on-delay and off-delay times separately to control the output terminal and relay operation times. The delay time set at codes OU.50-51 applies to multi-function output terminal (Q1) and relay (Relay 1), except when the multi-function output function is in fault trip mode.

Group	Code	Name	LCD Display	Parameter Setting	Setting Range	Unit
OU	50	Multi-function output On delay	DO On Delay	0.00	0.00-100.00	s
	51	Multi-function output Off delay	DO Off Delay	0.00	0.00-100.00	s
	52	Select multi-function output terminal	DO NC/NO Sel	00*	00-11	bit

* Displayed as  on keypad.

Output Terminal Delay Time Setting Details

Code	Description									
OU.52 DO NC/NO Sel	Select terminal type for relay and multi-function output terminal. An additional three terminal type selection bits at the terminal block will be added when an expansion I/O is added. By setting the relevant bit to 0, it will operate A terminal (Normally Open), and setting it to 1 will operate B terminal (Normally Closed). Shown below in the table are Relay 1 and Q1 settings starting from the right bit.									
	<table border="1"> <thead> <tr> <th>Item</th> <th>bit on</th> <th>bit off</th> </tr> </thead> <tbody> <tr> <td>Keypad</td> <td></td> <td></td> </tr> <tr> <td>LCD keypad</td> <td></td> <td></td> </tr> </tbody> </table>	Item	bit on	bit off	Keypad			LCD keypad		
	Item	bit on	bit off							
	Keypad									
LCD keypad										

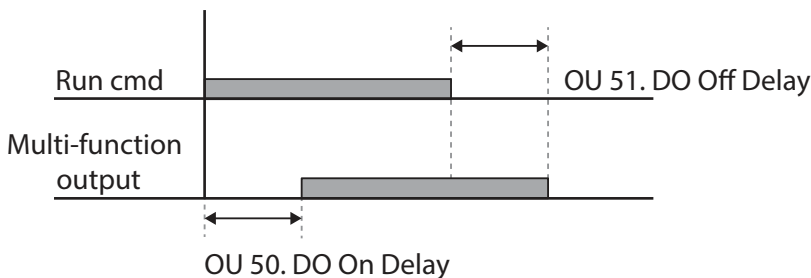

5.35 Keypad Language Settings

Select the language to be displayed on the LCD keypad. Keypad S/W Ver 1.04 and above provides language selections.

Group	Code	Name	LCD Display	Parameter Setting		Setting Range	Unit
CNF*	01	Select keypad language	Language Sel	0	English	-	-
				1	Korean		

* Available on LCD keypad only.

5.36 Operation State Monitor

The inverter's operation condition can be monitored using the LCD keypad. If the monitoring option is selected in config (CNF) mode, a maximum of four items can be monitored simultaneously. Monitoring mode displays three different items on the LCD keypad, but only one item can be displayed in the status window at a time.

Group	Code	Name	LCD Display	Parameter Setting		Setting Range	Unit
CNF*	20	Display item condition display window	Anytime Para	0	Frequency	-	-
	21	Monitor mode display 1	Monitor Line-1	0	Frequency	-	Hz
	22	Monitor mode display 2	Monitor Line-2	2	Output Current	-	A
	23	Monitor mode display 3	Monitor Line-3	3	Output Voltage	-	V
	24	Monitor mode initialize	Mon Mode Init	0	No	-	-

*Available on LCD keypad only.

Operation State Monitor Setting Details

Code	Description															
CNF-20 AnyTime Para	Select items to display on the top-right side of the LCD keypad screen. Choose the parameter settings based on the information to be displayed. Codes CNF-20–23 share the same setting options as listed in the table below.															
	<table border="1"> <thead> <tr> <th colspan="2">Setting</th> <th>Function</th> </tr> </thead> <tbody> <tr> <td>0</td> <td>Frequency</td> <td>On stop, displays the set frequency. During operation, displays the actual output frequency (Hz).</td> </tr> <tr> <td>1</td> <td>Speed</td> <td>On stop, displays the set speed (rpm). During operation, displays the actual operating speed (rpm).</td> </tr> <tr> <td>2</td> <td>Output Current</td> <td>Displays output current.</td> </tr> <tr> <td>3</td> <td>Output Voltage</td> <td>Displays output voltage.</td> </tr> </tbody> </table>	Setting		Function	0	Frequency	On stop, displays the set frequency. During operation, displays the actual output frequency (Hz).	1	Speed	On stop, displays the set speed (rpm). During operation, displays the actual operating speed (rpm).	2	Output Current	Displays output current.	3	Output Voltage	Displays output voltage.
	Setting		Function													
	0	Frequency	On stop, displays the set frequency. During operation, displays the actual output frequency (Hz).													
	1	Speed	On stop, displays the set speed (rpm). During operation, displays the actual operating speed (rpm).													
2	Output Current	Displays output current.														
3	Output Voltage	Displays output voltage.														

Code	Description		
	4	Output Power	Displays output power.
	5	WHour Counter	Displays inverter power consumption.
	6	DCLink Voltage	Displays DC link voltage within the inverter.
	7	DI Status	Displays input terminal status of the terminal block. Starting from the right, displays P1-P8.
	8	DO Status	Displays output terminal status of the terminal block. Starting from the right, Relay1, Relay2, and Q1.
	9	V1 Monitor[V]	Displays the input voltage value at terminal V1 (V).
	10	V1 Monitor[%]	Displays input voltage terminal V1 value as a percentage. If -10V, 0V, +10V is measured, -100%, 0%, 100% will be displayed.
	13	V2 Monitor[V]	Displays input voltage terminal V2 value (V).
	14	V2 Monitor[%]	Displays input voltage terminal V2 value as a percentage.
	15	I2 Monitor[mA]	Displays input current terminal I2 value (A).
	16	I2 Monitor[%]	Displays input current terminal I2 value as a percentage.
	17	PID Output	Displays output of PID controller.
	18	PID Ref Value	Displays reference value of PID controller.
	19	PID Fdb Value	Displays feedback volume of PID controller.
	20	Torque	If the torque reference command mode (DRV-08) is set to a value other than keypad (0 or 1), the torque reference value is displayed.
	21	Torque Limit	If torque limit setting (Cn.53) is set to a value other than keypad (0 or 1), the torque limit value is displayed.
	23	Spd Limit	If the speed limit setting (Cn.62) on torque control mode is set to a value other than keypad (0 or 1), the speed limit setting is displayed.
CNF-21-23 Monitor Line-x			Select the items to be displayed in monitor mode. Monitor mode is the first displayed mode when the inverter is powered on. A total of three items, from monitor line-1 to monitor line- 3, can be displayed simultaneously.
CNF-24 Mon Mode Init			Selecting 1(Yes) initializes CNF-20-23.

Note

Inverter power consumption

Values are calculated using voltage and current. Electric power is calculated every second and the results are accumulated. Setting CNF-62 (WH Count Reset) value to 1 (Yes) will reset cumulated electric energy consumption. Power consumption is displayed as shown below:

- Less than 1,000 kW: Units are in kW, displayed in 999.9 kW format.
- 1–99 MW: Units are in MW, displayed in 99.99 MWh format.
- 100–999 MW: Units are in MW, displayed in 999.9 MWh format.
- More than 1,000 MW: Units are in MW, displayed in 9,999 MWh format and can be displayed up to 65,535 MW. (Values exceeding 65,535MW will reset the value to 0, and units will return to kW. It will be displayed in 999.9 kW format).

5.37 Operation Time Monitor

Monitors inverter and fan operation time.

Group	Code	Name	LCD Display	Parameter Setting		Setting Range	Unit
CNF*	70	Inverter operation accumulated time	On-time	0/00/00 00:00		-	min
	71	Inverter operation accumulated time	Run-time	0/00/00 00:00		-	min
	72	Inverter operation accumulated time initialization	Time Reset	0	No	0–1	-
	74	Cooling fan operation accumulated time	Fan time	0/00/00 00:00		-	min
	75	Cooling fan operation accumulated time initialization	Fan Time Reset	0	No	0–1	-

*Available on LCD keypad only.

Operation Time Monitor Setting Details

Code	Description
CNF-70 On-time	Displays accumulated power supply time. Information is displayed in [YY/MM/DD Hr: Min (0/00/00 00: 00)] format.
CNF-71 Run-time	Displays accumulated time of voltage output by operation command input. Information is displayed in [YY/MM/DD Hr: Min (0/00/00 00: 00)] format.
CNF-72 Time Reset	Setting 1 (Yes) will delete power supply accumulated time (On-time) and operation accumulated time (Run-time) and is displayed as 0/00/00 00:00 format.

Code	Description
CNF-74 Fan time	Displays accumulated time of inverter cooling fan operation. Information will be displayed in [YY/MM/DD Hr: Min (0/00/00 00: 00)] format.
CNF-75 Fan Time Reset	Setting 1(Yes) will delete cooling fan operation accumulated time(on-time) and operation accumulated time (Run-time) and will display it in 0/00/00 00:00 format.

6 Learning Protection Features

Protection features provided by the S100 series inverter are categorized into two types: protection from overheating damage to the motor, and protection against the inverter malfunction.

6.1 Motor Protection

6.1.1 Electronic Thermal Motor Overheating Prevention (ETH)

ETH is a protective function that uses the output current of the inverter without a separate temperature sensor, to predict a rise in motor temperature to protect the motor based on its heat characteristics.

Group	Code	Name	LCD Display	Parameter Setting		Setting range	Unit
Pr	40	Electronic thermal prevention fault trip selection	ETH Trip Sel	0	None	0-2	-
	41	Motor cooling fan type	Motor Cooling	0	Self-cool	-	-
	42	Electronic thermal one minute rating	ETH 1min	150		120-200	%
	43	Electronic thermal prevention continuous rating	ETH Cont	120		50-150	%

Electronic Thermal (ETH) Prevention Function Setting Details

Code	Description								
Pr.40 ETH Trip Sel	ETH can be selected to provide motor thermal protection. The LCD screen displays "E-Thermal."								
	<table border="1"> <thead> <tr> <th>Setting</th> <th>Function</th> </tr> </thead> <tbody> <tr> <td>0 None</td> <td>The ETH function is not activated.</td> </tr> <tr> <td>1 Free-Run</td> <td>The inverter output is blocked. The motor coasts to a halt (free-run).</td> </tr> <tr> <td>2 Dec</td> <td>The inverter decelerates the motor to a stop.</td> </tr> </tbody> </table>	Setting	Function	0 None	The ETH function is not activated.	1 Free-Run	The inverter output is blocked. The motor coasts to a halt (free-run).	2 Dec	The inverter decelerates the motor to a stop.
	Setting	Function							
	0 None	The ETH function is not activated.							
1 Free-Run	The inverter output is blocked. The motor coasts to a halt (free-run).								
2 Dec	The inverter decelerates the motor to a stop.								
Pr.41 Motor Cooling	Select the drive mode of the cooling fan, attached to the motor.								
	<table border="1"> <thead> <tr> <th>Setting</th> <th>Function</th> </tr> </thead> <tbody> <tr> <td>0 Self-cool</td> <td>As the cooling fan is connected to the motor axis, the</td> </tr> </tbody> </table>	Setting	Function	0 Self-cool	As the cooling fan is connected to the motor axis, the				
Setting	Function								
0 Self-cool	As the cooling fan is connected to the motor axis, the								

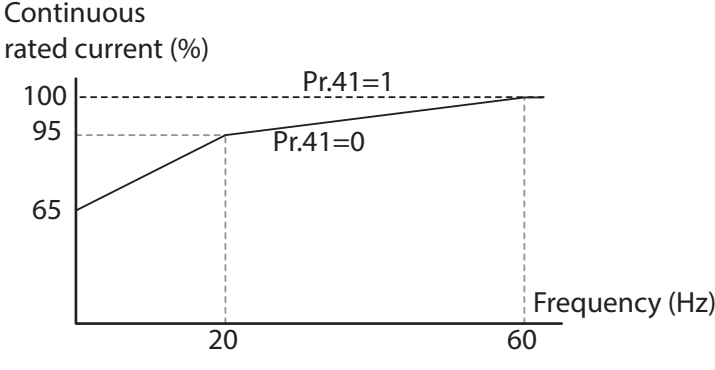
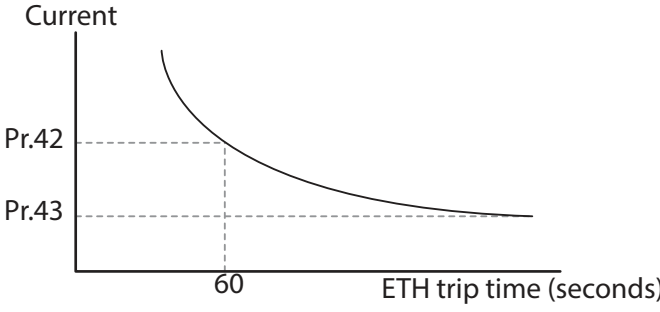
Code	Description	
		cooling effect varies, based on motor speed. Most universal induction motors have this design.
	1 Forced-cool	Additional power is supplied to operate the cooling fan. This provides extended operation at low speeds. Motors designed for inverters typically have this design.
	<p>Continuous rated current (%)</p>  <p>Frequency (Hz)</p>	
Pr.42 ETH 1 min	The amount of input current that can be continuously supplied to the motor for 1 minute, based on the motor-rated current (bA.13).	
Pr.43 ETH Cont	<p>Sets the amount of current with the ETH function activated. The range below details the set values that can be used during continuous operation without the protection function.</p>  <p>ETH trip time (seconds)</p>	

6.1.2 Overload Early Warning and Trip

A warning or fault 'trip' (cutoff) occurs when the motor reaches an overload state, based on the motor's rated current. The amount of current for warnings and trips can be set separately.

Group	Code	Name	LCD Display	Parameter Setting		Setting range	Unit
Pr	04	Load level setting	Load Duty	1	Heavy Duty	-	-
	17	Overload warning selection	OL Warn Select	1	Yes	0-1	-
	18	Overload warning level	OL Warn Level	150		30-180	%
	19	Overload warning time	OL Warn Time	10.0		0-30	s
	20	Motion at overload trip	OL Trip Select	1	Free-Run	-	-
	21	Overload trip level	OL Trip Level	180		30-200	%
	22	Overload trip time	OL Trip Time	60.0		0-60.0	s
OU	31	Multi-function relay 1 item	Relay 1	5	Over Load	-	-
	33	Multi-function output 1 item	Q1 Define				

Overload Early Warning and Trip Setting Details

Coden	Description								
Pr.04 Load Duty	Select the load level.								
	<table border="1"> <thead> <tr> <th>Setting</th> <th>Function</th> </tr> </thead> <tbody> <tr> <td>0</td> <td>Normal Duty Used in underloads, like fans and pumps (overload tolerance: 120% of rated underload current for 1 minute).</td> </tr> <tr> <td>1</td> <td>Heavy Duty Used in heavy loads, like hoists, cranes, and parking devices (overload tolerance: 150% of rated heavy load current for 1 minute).</td> </tr> </tbody> </table>	Setting	Function	0	Normal Duty Used in underloads, like fans and pumps (overload tolerance: 120% of rated underload current for 1 minute).	1	Heavy Duty Used in heavy loads, like hoists, cranes, and parking devices (overload tolerance: 150% of rated heavy load current for 1 minute).		
	Setting	Function							
0	Normal Duty Used in underloads, like fans and pumps (overload tolerance: 120% of rated underload current for 1 minute).								
1	Heavy Duty Used in heavy loads, like hoists, cranes, and parking devices (overload tolerance: 150% of rated heavy load current for 1 minute).								
Pr.17 OL Warn Select	If the overload reaches the warning level, the terminal block multi-function output terminal and relay are used to output a warning signal. If 1 (Yes) is selected, it will operate. If 0 (No) is selected, it will not operate.								
Pr.18 OL Warn Level, Pr.19 OL Warn Time	When the input current to the motor is greater than the overload warning level (OL Warn Level) and continues at that level during the overload warning time (OL Warn Time), the multi-function output (Relay 1, Q1) sends a warning signal. When Over Load is selected at OU.31 and 33, the multi-function output terminal or relay outputs a signal. The the signal output does not block the inverter output.								
Pr.20 OL Trip Select	Select the inverter protective action in the event of an overload fault trip.								
	<table border="1"> <thead> <tr> <th>Setting</th> <th>Function</th> </tr> </thead> <tbody> <tr> <td>0</td> <td>None No protective action is taken.</td> </tr> <tr> <td>1</td> <td>Free-Run In the event of an overload fault, inverter output is blocked and the motor will free-run due to inertia.</td> </tr> <tr> <td>3</td> <td>Dec If a fault trip occurs, the motor decelerates and stops.</td> </tr> </tbody> </table>	Setting	Function	0	None No protective action is taken.	1	Free-Run In the event of an overload fault, inverter output is blocked and the motor will free-run due to inertia.	3	Dec If a fault trip occurs, the motor decelerates and stops.
	Setting	Function							
	0	None No protective action is taken.							
1	Free-Run In the event of an overload fault, inverter output is blocked and the motor will free-run due to inertia.								
3	Dec If a fault trip occurs, the motor decelerates and stops.								
Pr.21 OL Trip Level, Pr.22 OL Trip Time	When the current supplied to the motor is greater than the preset value at the overload trip level (OL Trip Level) and continues to be supplied during the overload trip time (OL Trip Time), the inverter output is either blocked according to the preset mode from Pr. 17 or slows to a stop after deceleration.								

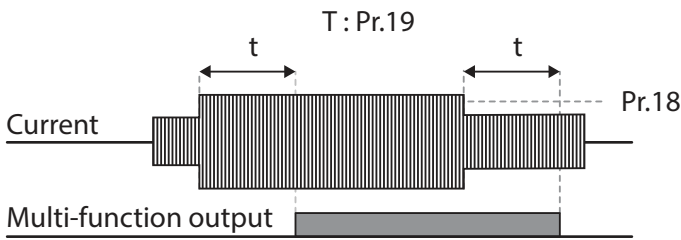

Note

Overload warnings warn of an overload before an overload fault trip occurs. The overload warning signal may not work in an overload fault trip situation, if the overload warn level (OL Warn Level) and the overload warn time (OL Warn Time) are set higher than the overload trip level (OL Trip Level) and overload trip time (OL Trip Time).

6.1.3 Stall Prevention and Flux Braking

The stall prevention function is a protective function that prevents motor stall caused by overloads. If a motor stall occurs due to an overload, the inverter operation frequency is adjusted automatically. When stall is caused by overload, high currents are induced in the motor may cause motor overheat or damage the motor and interrupt operation of the motor-driven devices.

To protect the motor from overload faults, the inverter output frequency is adjusted automatically, based on the size of load.

Group	Code	Name	LCD Display	Parameter Setting	Setting range	Unit
Pr	50	Stall prevention and flux braking	Stall Prevent	0000*	-	bit
	51	Stall frequency 1	Stall Freq 1	60.00	Start frequency–Stall Freq 1	Hz
	52	Stall level 1	Stall Level 1	180	30-250	%
	53	Stall frequency 2	Stall Freq 2	60.00	Stall Freq 1–Stall Freq 3	Hz
	54	Stall level 2	Stall Level 2	180	30-250	%
	55	Stall frequency 3	Stall Freq 3	60.00	Stall Freq 2–Stall Freq 4	Hz
	56	Stall level 3	Stall Level 3	180	30-250	%
	57	Stall frequency 4	Stall Freq 4	60.00	Stall Freq 3–Maximum frequency	Hz
	58	Stall level 4	Stall Level 4	180	30-250	%

Group	Code	Name	LCD Display	Parameter Setting	Setting range	Unit
OU	31	Multi-function relay 1 item	Relay 1	9	Stall	-
	33	Multi-function output 1 item	Q1 Define			

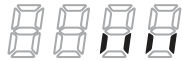

* The value is displayed on the keypad as .

Stall Prevention Function and Flux Braking Setting Details

Code	Description																												
Pr.50 Stall Prevent	Stall prevention can be configured for acceleration, deceleration, or while operating a motor at constant speed. When the top LCD segment is on, the corresponding bit is set. When the bottom LCD segment is on, the corresponding bit is off.																												
	<table border="1"> <thead> <tr> <th>Item</th> <th>Bit Status (On)</th> <th>Bit Status (Off)</th> </tr> </thead> <tbody> <tr> <td>Keypad</td> <td></td> <td></td> </tr> <tr> <td>LCD keypad</td> <td></td> <td></td> </tr> </tbody> </table>	Item	Bit Status (On)	Bit Status (Off)	Keypad			LCD keypad																					
	Item	Bit Status (On)	Bit Status (Off)																										
	Keypad																												
	LCD keypad																												
	<table border="1"> <thead> <tr> <th colspan="4">Setting</th> <th rowspan="2">Function</th> </tr> <tr> <th>Bit 4</th> <th>Bit 3</th> <th>Bit 2</th> <th>Bit 1</th> </tr> </thead> <tbody> <tr> <td></td> <td></td> <td></td> <td>✓</td> <td>Stall protection during acceleration</td> </tr> <tr> <td></td> <td></td> <td>✓</td> <td></td> <td>Stall protection while operating at a constant speed</td> </tr> <tr> <td></td> <td>✓</td> <td></td> <td></td> <td>Stall protection during deceleration</td> </tr> <tr> <td>✓</td> <td></td> <td></td> <td></td> <td>Flux braking during deceleration</td> </tr> </tbody> </table>	Setting				Function	Bit 4	Bit 3	Bit 2	Bit 1				✓	Stall protection during acceleration			✓		Stall protection while operating at a constant speed		✓			Stall protection during deceleration	✓			
Setting				Function																									
Bit 4	Bit 3	Bit 2	Bit 1																										
			✓	Stall protection during acceleration																									
		✓		Stall protection while operating at a constant speed																									
	✓			Stall protection during deceleration																									
✓				Flux braking during deceleration																									
<table border="1"> <thead> <tr> <th colspan="2">Setting</th> <th>Function</th> </tr> </thead> <tbody> <tr> <td>0001</td> <td>Stall protection during acceleration</td> <td>If inverter output current exceeds the preset stall level (Pr. 52, 54, 56, 58) during acceleration, the motor stops accelerating and starts decelerating. If current level stays above the stall level, the motor decelerates to the start frequency (dr.19). If the current level causes deceleration below the preset level while operating the stall protection function, the motor resumes acceleration.</td> </tr> <tr> <td>0010</td> <td>Stall protection while operating at constant speed</td> <td>Similar to stall protection function during acceleration, the output frequency automatically decelerates when the current level exceeds the preset stall level while operating at constant speed. When the load current decelerates below the preset level, it resumes acceleration.</td> </tr> <tr> <td>0100</td> <td>Stall</td> <td>The inverter decelerates and keeps the DC link voltage</td> </tr> </tbody> </table>	Setting		Function	0001	Stall protection during acceleration	If inverter output current exceeds the preset stall level (Pr. 52, 54, 56, 58) during acceleration, the motor stops accelerating and starts decelerating. If current level stays above the stall level, the motor decelerates to the start frequency (dr.19). If the current level causes deceleration below the preset level while operating the stall protection function, the motor resumes acceleration.	0010	Stall protection while operating at constant speed	Similar to stall protection function during acceleration, the output frequency automatically decelerates when the current level exceeds the preset stall level while operating at constant speed. When the load current decelerates below the preset level, it resumes acceleration.	0100	Stall	The inverter decelerates and keeps the DC link voltage																	
Setting		Function																											
0001	Stall protection during acceleration	If inverter output current exceeds the preset stall level (Pr. 52, 54, 56, 58) during acceleration, the motor stops accelerating and starts decelerating. If current level stays above the stall level, the motor decelerates to the start frequency (dr.19). If the current level causes deceleration below the preset level while operating the stall protection function, the motor resumes acceleration.																											
0010	Stall protection while operating at constant speed	Similar to stall protection function during acceleration, the output frequency automatically decelerates when the current level exceeds the preset stall level while operating at constant speed. When the load current decelerates below the preset level, it resumes acceleration.																											
0100	Stall	The inverter decelerates and keeps the DC link voltage																											

Code	Description	
	protection during deceleration	below a certain level to prevent an over voltage fault trip during deceleration. As a result, deceleration times can be longer than the set time depending on the load.
1000	Flux braking during deceleration	When using flux braking, deceleration time may be reduced because regenerative energy is expended at the motor.
1100	Stall protection and flux braking during deceleration	Stall protection and flux braking operate together during deceleration to achieve the shortest and most stable deceleration performance.

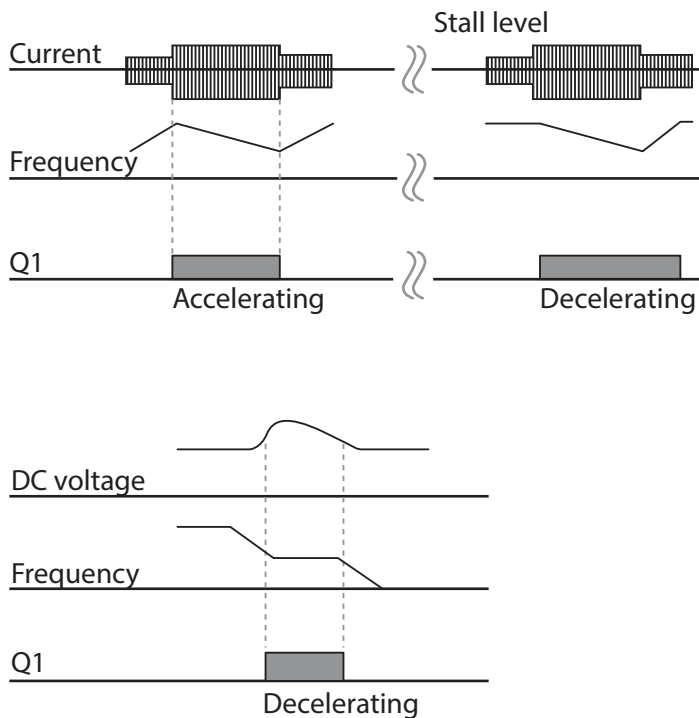

Pr.51 Stall Freq 1-Pr.58 Stall Level 4

Additional stall protection levels can be configured for different frequencies, based on the load type. As shown in the graph below, the stall level can be set above the base frequency. The lower and upper limits are set using numbers that correspond in ascending order. For example, the range for Stall Frequency 2 (Stall Freq 2) becomes the lower limit for Stall Frequency 1 (Stall Freq 1) and the upper limit for Stall Frequency 3 (Stall Freq 3).

Code	Description
	<p style="text-align: center;">Stall level</p>

Note

Stall protection and flux braking operate together only during deceleration. Turn on the third and fourth bits of Pr.50 (Stall Prevention) to achieve the shortest and most stable deceleration performance without triggering an overvoltage fault trip for loads with high inertia and short deceleration times. Do not use this function when frequent deceleration of the load is required, as the motor can overheat and may be damaged easily.

Caution

- Use caution when decelerating while using stall protection as depending on the load, the deceleration time can take longer than the time set. Acceleration stops when stall protection operates during acceleration. This may make the actual acceleration time longer than the preset acceleration time.
- When the motor is operating, Stall Level 1 applies and determines the operation of stall protection.

6.2 Inverter and Sequence Protection













6.2.1 Open-phase Protection

Open-phase protection is used to prevent overcurrent levels induced at the inverter inputs due to an open-phase within the input power supply. Open-phase output protection is also available. An open-phase at the connection between the motor and the inverter output may cause the motor to stall, due to a lack of torque.

Group	Code	Name	LCD Display	Parameter Setting	Setting range	Unit
Pr	05	Input/output open-phase protection	Phase Loss Chk	00*	-	bit
	06	Open-phase input voltage band	IPOV Band	40	1-100V	V



*The value is displayed on the keypad as .

Input and Output Open-phase Protection Setting Details

Code	Description										
Pr.05 Phase Loss Chk, Pr.06 IPOV Band	When open-phase protection is operating, input and output configurations are displayed differently. When the top LCD segment is On, the corresponding bit is set to On. When the bottom LCD segment is On, the corresponding bit is set to Off.										
	<table border="1"> <thead> <tr> <th>Item</th> <th>Bit status (On)</th> <th>Bit status (Off)</th> </tr> </thead> <tbody> <tr> <td>Keypad</td> <td></td> <td></td> </tr> <tr> <td>LCD keypad</td> <td></td> <td></td> </tr> </tbody> </table>	Item	Bit status (On)	Bit status (Off)	Keypad			LCD keypad			
	Item	Bit status (On)	Bit status (Off)								
	Keypad										
	LCD keypad										
<table border="1"> <thead> <tr> <th colspan="2">Setting</th> <th rowspan="2">Function</th> </tr> <tr> <th>Bit 2</th> <th>Bit 1</th> </tr> </thead> <tbody> <tr> <td></td> <td>✓</td> <td>Output open-phase protection</td> </tr> <tr> <td>✓</td> <td></td> <td>Input open-phase protection</td> </tr> </tbody> </table>	Setting		Function	Bit 2	Bit 1		✓	Output open-phase protection	✓		Input open-phase protection
Setting		Function									
Bit 2	Bit 1										
	✓	Output open-phase protection									
✓		Input open-phase protection									

6.2.2 External Trip Signal

Set one of the multi-function input terminals to 4 (External Trip) to allow the inverter to stop operation when abnormal operating conditions arise.

Group	Code	Name	LCD Display	Parameter Setting	Setting range	Unit
In	65-71	Px terminal setting options	Px Define (Px: P1-P7)	4 External Trip	-	-
	87	Multi-function input contact selection	DI NC/NO Sel	 	-	bit

External Trip Signal Setting Details

Code	Description																								
In.87 DI NC/NO Sel	<p>Selects the type of input contact. If the mark of the switch is at the bottom (0), it operates as an A contact (Normally Open). If the mark is at the top (1), it operates as a B contact (Normally Closed).</p> <p>The corresponding terminals for each bit are as follows:</p> <table border="1"> <thead> <tr> <th>Bit</th> <th>11</th> <th>10</th> <th>9</th> <th>8</th> <th>7</th> <th>6</th> <th>5</th> <th>4</th> <th>3</th> <th>2</th> <th>1</th> </tr> </thead> <tbody> <tr> <td>Terminal</td> <td></td> <td></td> <td></td> <td></td> <td>P7</td> <td>P6</td> <td>P5</td> <td>P4</td> <td>P3</td> <td>P2</td> <td>P1</td> </tr> </tbody> </table>	Bit	11	10	9	8	7	6	5	4	3	2	1	Terminal					P7	P6	P5	P4	P3	P2	P1
Bit	11	10	9	8	7	6	5	4	3	2	1														
Terminal					P7	P6	P5	P4	P3	P2	P1														

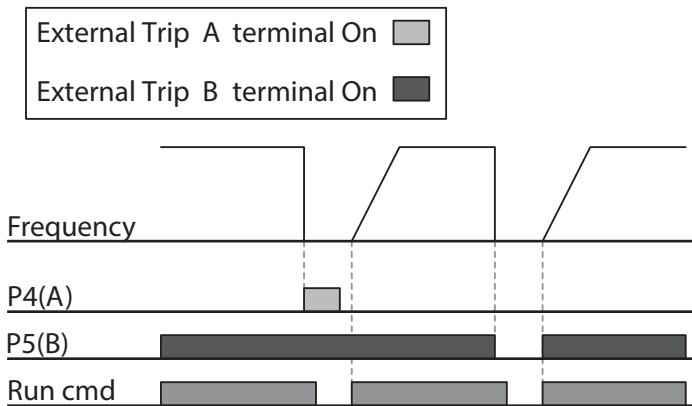

6.2.3 Inverter Overload Protection

When the inverter input current exceeds the rated current, a protective function is activated to prevent damages to the inverter based on inverse proportional characteristics.

Group	Code	Name	LCD Display	Parameter Setting	Setting range	Unit
OU	31	Multi-function relay 1	Relay 1	6	IOL	-
	33	Multi-function output 1	Q1 Define			

Note

A warning signal output can be provided in advance by the multi-function output terminal before the inverter overload protection function (IOLT) operates. When the overcurrent time reaches 60% of the allowed overcurrent (150%, 1 min), a warning signal output is provided (signal output at 150%, 36sec).

6.2.4 Speed Command Loss

When setting operation speed using an analog input at the terminal block, communication options, or the keypad, speed command loss setting can be used to select the inverter operation for situations when the speed command is lost due to the disconnection of signal cables.

Group	Code	Name	LCD Display	Parameter Setting		Setting range	Unit
Pr	12	Speed command loss operation mode	Lost Cmd Mode	1	Free-Run	-	-
	13	Time to determine speed command loss	Lost Cmd Time	1.0		0.1-120	s
	14	Operation frequency at speed command loss	Lost Preset F	0.00		Start frequency–Max. frequency	Hz
	15	Analog input loss decision level	AI Lost Level	0	Half of x1		-
OU	31	Multi-function Relay 1	Relay 1	13	Lost Command	-	-
	33	Multi-function output 1	Q1 Define				

Speed Command Loss Setting Details

Code	Description														
Pr.12 Lost Cmd Mode	In situations when speed commands are lost, the inverter can be configured to operate in a specific mode:														
	<table border="1"> <thead> <tr> <th>Setting</th> <th>Function</th> </tr> </thead> <tbody> <tr> <td>0</td> <td>None The speed command immediately becomes the operation frequency without any protection function.</td> </tr> <tr> <td>1</td> <td>Free-Run The inverter blocks output. The motor performs in free-run condition.</td> </tr> <tr> <td>2</td> <td>Dec The motor decelerates and then stops at the time set at Pr.07 (Trip Dec Time).</td> </tr> <tr> <td>3</td> <td>Hold Input The inverter calculates the average input value for 10 seconds before the loss of the speed command and uses it as the speed reference.</td> </tr> <tr> <td>4</td> <td>Hold Output The inverter calculates the average output value for 10 seconds before the loss of the speed command and uses it as the speed reference.</td> </tr> <tr> <td>5</td> <td>Lost Preset The inverter operates at the frequency set at Pr. 14 (Lost Preset F).</td> </tr> </tbody> </table>	Setting	Function	0	None The speed command immediately becomes the operation frequency without any protection function.	1	Free-Run The inverter blocks output. The motor performs in free-run condition.	2	Dec The motor decelerates and then stops at the time set at Pr.07 (Trip Dec Time).	3	Hold Input The inverter calculates the average input value for 10 seconds before the loss of the speed command and uses it as the speed reference.	4	Hold Output The inverter calculates the average output value for 10 seconds before the loss of the speed command and uses it as the speed reference.	5	Lost Preset The inverter operates at the frequency set at Pr. 14 (Lost Preset F).
	Setting	Function													
	0	None The speed command immediately becomes the operation frequency without any protection function.													
	1	Free-Run The inverter blocks output. The motor performs in free-run condition.													
	2	Dec The motor decelerates and then stops at the time set at Pr.07 (Trip Dec Time).													
	3	Hold Input The inverter calculates the average input value for 10 seconds before the loss of the speed command and uses it as the speed reference.													
4	Hold Output The inverter calculates the average output value for 10 seconds before the loss of the speed command and uses it as the speed reference.														
5	Lost Preset The inverter operates at the frequency set at Pr. 14 (Lost Preset F).														
Pr.15 AI Lost Level, Pr.13 Lst Cmd Time	Configure the voltage and decision time for speed command loss when using analog input.														
	<table border="1"> <thead> <tr> <th>Setting</th> <th>Function</th> </tr> </thead> <tbody> <tr> <td>0</td> <td>Half of x1 Based on the values set at In.08 and In.12,</td> </tr> </tbody> </table>	Setting	Function	0	Half of x1 Based on the values set at In.08 and In.12,										
	Setting	Function													
0	Half of x1 Based on the values set at In.08 and In.12,														

Code	Description	
		protective operation starts when the input signal is reduced to half of the initial value of the analog input set using the speed command (Frq code of Operation group) and it continues for the time (speed loss decision time) set at Pr. 13 (Lost Cmd Time). For example, set the speed command to 2 (V1) at the Frq code in the Operation group, and In.06 (V1 Polarity) to 0 (Unipolar). When the voltage input drops to less than half of the value set at In.08 (V1 Volt x 1), the protective function is activated.
	1	Below x1 The protective operation starts when the signal becomes smaller than the initial value of the analog input set by the speed command and it continues for the speed loss decision time set at Pr.13 (Lost Cmd Time). Codes In.08 and In.12 are used to set the standard values.
Pr.14 Lost Preset F	In situations where speed commands are lost, set the operation mode (Pr.12 Lost Cmd Mode) to 5 (Lost Preset). This operates the protection function and sets the frequency so that the operation can continue.	

Set Pr.15 (AI Lost Level) to 1 (Below x 1), Pr.12 (Lost Cmd Mode) to 2 (Dec), and Pr.13 (Lost Cmd Time) to 5 sec. Then it operates as follows:

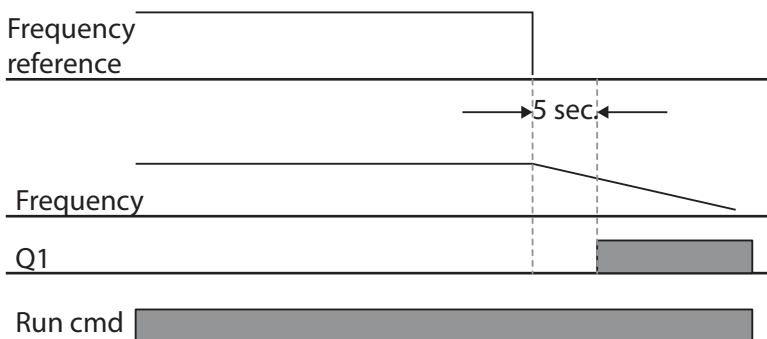

Note

If speed command is lost while using communication options or the integrated RS-485 communication, the protection function operates after the command loss decision time set at Pr.13 (Lost Cmd Time) is passed.

6.2.5 Dynamic Braking (DB) Resistor Configuration

For S100 series, the braking resistor circuit is integrated inside the inverter.

Group	Code	Name	LCD Display	Parameter Setting		Setting range	Unit
Pr	66	Braking resistor configuration	DB Warn %ED	10		0-30	%
OU	31	Multi-function relay 1 item	Relay 1	31	DB Warn %ED	-	-
	33	Multi-function output 1 item	Q1 Define				

Dynamic Braking Resistor Setting Details

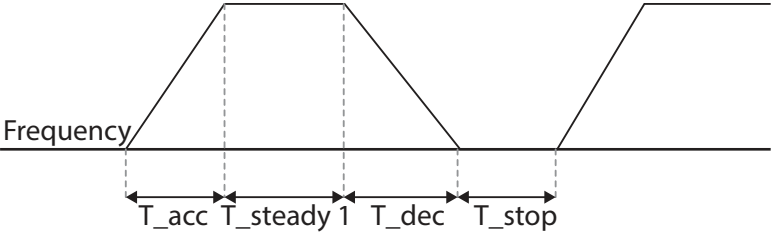
Code	Description
Pr.66 DB Warn %ED	<p>Set braking resistor configuration (%ED: Duty cycle). Braking resistor configuration sets the rate at which the braking resistor operates for one operation cycle. The maximum time for continuous braking is 15 sec and the braking resistor signal is not output from the inverter after the 15 sec period has expired. An example of braking resistor set up is as follows:</p> $\%ED = \frac{T_{dec}}{T_{acc} + T_{steady} + T_{dec} + T_{stop}} \times 100\%$  <p>[Example 1]</p> $\%ED = \frac{T_{dec}}{T_{dec} + T_{steady1} + T_{acc} + T_{steady2}} \times 100\%$

Code	Description
	<p>The diagram shows a frequency profile over time. It starts with a deceleration phase labeled T_{dec}, followed by a constant speed operation phase labeled $T_{steady 1}$. Then, it shows an acceleration phase labeled T_{acc}, followed by another constant speed operation phase labeled $T_{steady 2}$. The y-axis is labeled 'Frequency'.</p> <p>[Example 2]</p> <ul style="list-style-type: none"> • T_{acc}: Acceleration time to set frequency • T_{steady}: Constant speed operation time at set frequency • T_{dec}: Deceleration time to a frequency lower than constant speed operation or the stop time from constant speed operation frequency • T_{stop}: Stop time until operation resumes

Caution

Do not set the braking resistor to exceed the resistor’s power rating. If overloaded, it can overheat and cause a fire. When using a resistor with a heat sensor, the sensor output can be used as an external trip signal for the inverter’s multi-function input.

Protection Features

6.3 Under load Fault Trip and Warning

Group	Code	Name	LCD Display	Parameter Setting		Setting range	Unit
Pr	04	Load level selection	Load Duty	0	Normal Duty	-	
	25	Under load warning selection	UL Warn Sel	1	Yes	0-1	-
	26	Under load warning time	UL Warn Time	10.0		0-600	sec
	27	Under load trip selection	UL Trip Sel	1	Free-Run	-	-
	28	Under load trip timer	UL Trip Time	30.0		0-600	sec
	29	Under load upper limit level	UL LF Level	30		10-100	%
	30	Under load lower limit level	UL BF Level	30		10-100	%

Under Load Trip and Warning Setting Details

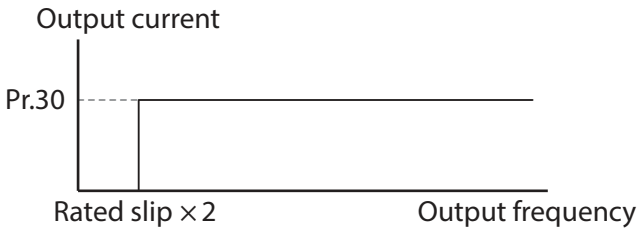
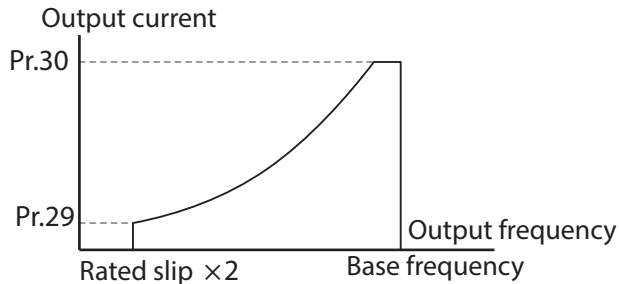
Code	Description
Pr.27 UL Trip Sel	Sets the underload fault trip occurs. If set to 0(None), does not detect the underload fault trip. If set to 1 (Free-Run), the output is blocked in an underload fault trip situation. If set to 2 (Dec), the motor decelerates and stops when an underload trip occurs.
Pr.25 UL Warn Sel	Sets the underload warning options. Set to 1(Yes) and set the multi-function output terminals (at OU-31 and 33) to 7 (Underload). The warning signals are output when an underload condition arises.
Pr.26 UL Warn Time, Pr.28 UL Trip Time	The protection function operates when the underload level condition explained above is maintained for a set warning time or fault trip time. This function does not operate if energy-saving operation is activated at Ad-50 (E-Save Mode).
Pr.29 UL LF Level, Pr.30 UL BF Level	<ul style="list-style-type: none"> Setting Heavy Duty <ul style="list-style-type: none"> - Do not support Pr.29. - At Pr.30, the underload level is decided based on the motor's rated current.  <ul style="list-style-type: none"> Setting Normal Duty <ul style="list-style-type: none"> - At Pr.29, the under load rate is decided based on twice the operation frequency of the motor's rated slip speed (bA.12 Rated Slip). - At Pr.30, the under load rate is decided based on the base frequency set at dr.18 (Base Freq).An upper limit and lower limit is based on the inverter's rated current. 

6.3.1 Fan Fault Detection

Group	Code	Name	LCD Display	Parameter Setting	Setting range	Unit
Pr	79	Cooling fan fault selection	FAN Trip Mode	0	Trip	
OU	31	Multi-function relay 1	Relay 1	8	FAN Warning	-
OU	33	Multi-function output 1	Q1 Define			

Fan Fault Detection Setting Details

Code	Description						
Pr.79 FAN Trip Mode	Set the cooling fan fault mode.						
	<table border="1"> <thead> <tr> <th>Setting</th> <th>Function</th> </tr> </thead> <tbody> <tr> <td>0</td> <td>Trip The inverter output is blocked and the fan trip is displayed when a cooling fan error is detected.</td> </tr> <tr> <td>1</td> <td>Warning When OU.33 (Q1 Define) and OU.31 (Relay1) are set to 8 (FAN Warning), the fan error signal is output and the operation continues.</td> </tr> </tbody> </table>	Setting	Function	0	Trip The inverter output is blocked and the fan trip is displayed when a cooling fan error is detected.	1	Warning When OU.33 (Q1 Define) and OU.31 (Relay1) are set to 8 (FAN Warning), the fan error signal is output and the operation continues.
	Setting	Function					
0	Trip The inverter output is blocked and the fan trip is displayed when a cooling fan error is detected.						
1	Warning When OU.33 (Q1 Define) and OU.31 (Relay1) are set to 8 (FAN Warning), the fan error signal is output and the operation continues.						
OU.33 Q1 Define, OU.31 Relay1	When the code value is set to 8 (FAN Warning), the fan error signal is output and operation continues. However, when the inverter inside temperature rises above a certain level, output is blocked due to activation of overheat protection.						

6.3.2 Lifetime diagnosis of components

Registering a capacitance reference for inspection

Note

To perform a capacitor diagnosis, a capacitance reference must be measured and registered by setting Pr-61 (CAP Diag) to 1 (Ref Diag) when the inverter is used for the first time. The measured reference value is saved at Pr-63 and is used as the reference for the capacitor life diagnosis.

Refer to the following instructions to measure a reference capacitance.

- 1 Set an appropriate capacitor diagnosis current based on the inverter's rated output at Pr-60 (CAP DiagCurr).
 - The capacitor diagnosis current is a direct current that is applied to the capacitor for inspection, and is defined as a percentage of the rated inverter output. Because the value is defined based on the inverter output, set an appropriate value if the motor has smaller rated current.
- 2 At Pr-62 (CAP Exchange Level), set the capacitor replacement warning level to a value

between 50.0% and 95.0%

- 3 Set Pr-61 (CAP Diag) to "1" (Ref Diag). Then, the direct current set at Pr-60 (CAP DiagCurr) is output.
 - The capacitor diagnosis is only available when the inverter is stopped.
 - If Pr-61 is set to 1 (Ref Diag), the displayed value at Pr-63 reflects 100% of the measured capacitance.
 - If you plan to perform a capacitor diagnosis using Pr-61 (CAP Diag), the initial capacitance must be measured when the inverter is used for the first time. A capacitance measured on a used inverter leads to inaccurate inspection results due to an incorrect reference capacitance value.
- 4 Turn off the input to the inverter.
- 5 Turn on the inverter when a low voltage trip (LVT) occurs.
- 6 View the value displayed at Pr-63 (CAP Diag Level). When Pr-61 is set to "1" (Ref Diag), Pr-63 displays 100% of the capacitance.

[Main Capacitor Diagnosis details]

Group	Code	Name	LCD Display	Setting value	Setting Range	Unit	
Pr	60	Capacitance Diagnose current Level	CAP. DiagPerc	0.0	10.0-100.0	%	
	61	CAP. Diagnosis mode	CAP. Diag	0	0	None	%
					1	Ref Diag	
					2	Pre Diag	
					3	Init Diag	
62	CAP Exchange Level	CAP Exchange Level	0	50.0 ~ 95.0	%		
63	CAP Diag Level	CAP Diag Level	0	0.0 ~ 100.0	%		

Inspecting the capacitor life and initializing the capacitance reference

Refer to the following instructions to inspect the capacitor life and initialize the capacitance reference.

Note

To perform a capacitor diagnosis, a capacitance reference must be measured and registered by setting Pr-61 (CAP Diag) to 1 (Ref Diag) when the inverter is used for the first time. The measured reference value is registered at Pr-63, and is used as the reference for the capacitor life diagnosis.

- 1 On an inverter whose run time has reached the cumulated time for capacitor replacement, set Pr-61 (CAP Diag) to 2 (Pre Diag).
- 2 Check the value displayed at Pr-63 (CAP Diag Level). If the value displayed at Pr-63 is smaller than the value set at Pr-62 (CAP. Level 1), a capacitor replacement warning (CAP Exchange) will occur.
- 3 While the capacitor replacement warning continues, confirm that the first bit at Pr-89 (Inverter State) is set.
- 4 Set Pr-62 to 0.0%. The capacitor replacement warning (CAP Exchange) will be released.
- 5 Set Pr-61 to 3 (CAP. Init) and make sure that the value displayed at Pr-63 has changed to 0.0%.

Lifetime diagnosis for fans

Enter the Pr-87(Fan exchange warning level) code (%). After the selected usage (%) is reached (out of 50,000 hours), the fan exchange warning message will appear in the multi-functional output or keypad.

The total fan usage level (%) appears at Pr-86. When exchanging fans, you may initialize the accumulated value to 0 by setting the CNF-75 (Initializing accumulated time for cooling fans) to 1.

Group	Code	Name	LCD Display	Setting value		Setting Range	Unit
Pr	86	Accumulated percent of fan usage	FAN Time Perc	0.0		0.0-6553.5	%
	87	Fan exchange warning Level	FAN Exchange level	90.0		0.0-100.0	%
CNF*	75	Initialize operation time of cooling fans	FAN Time Rst	0	No	-	-
				1	Yes		
OU	31	Multi-function relay 1	Relay 1	38	FAN Exchange		-
	32	Multi-function relay 2	Relay 2				
	33	Multi-function output 1	Q1 Define				

*Available on LCD keypad only.

6.3.3 Low Voltage Fault Trip

When inverter input power is lost and the internal DC link voltage drops below a certain voltage level, the inverter stops output and a low voltage trip occurs.

Group	Code	Name	LCD Display	Parameter Setting	Setting range	Unit
Pr	81	Low voltage trip	LVT Delay	0.0	0-60	sec

Group	Code	Name	LCD Display	Parameter Setting		Setting range	Unit
		decision delay time					
OU	31	Multi-function relay 1	Relay 1	11	Low Voltage		-
	33	Multi-function output 1	Q1 Define				

Low Voltage Fault Trip Setting Details

Code	Description
Pr.81 LVT Delay	If the code value is set to 11 (Low Voltage), the inverter stops the output first when a low voltage trip condition arises, then a fault trip occurs after the low voltage trip decision time is passed. The warning signal for a low voltage fault trip can be provided using the multi-function output or a relay. However, the low voltage trip delay time (LVT Delay time) does not apply to warning signals.

6.3.4 Output Block by Multi-Function Terminal

When the multi-function input terminal is set as the output block signal terminal and the signal is input to the terminal, then the operation stops.

Group	Code	Name	LCD Display	Parameter Setting		Setting range	Unit
In	65-71	Px terminal setting options	Px Define(Px: P1-P7)	5	BX	-	-

Output Block by Multi-Function Terminal Setting Details

Code	Description
In.65-71 Px Define	When the operation of the multi-function input terminal is set to 5 (BX) and is turned on during operation, the inverter blocks the output and 'BX' is displayed on the keypad display. While 'BX' is displayed on the keypad screen, the inverter's operation information including the operation frequency and current at the time of BX signal can be monitored. The inverter resumes operation when the BX terminal turns off and operation command is input.

6.3.5 Trip Status Reset

Restart the inverter using the keypad or analog input terminal, to reset the trip status.

Group	Code	Name	LCD Display	Parameter Setting		Setting range	Unit
In	65-71	Px terminal setting options	Px Define(Px: P1-P7)	3	RST	-	-

Trip Status Reset Setting Details

Code	Description
In.65-71 Px Define	Press [Stop/Reset] key on the keypad or use the multi-function input terminal to restart the inverter. Set the multi-function input terminal to 3 (RST) and turn on the terminal to reset the trip status.

6.3.6 Inverter Diagnosis State

Check the diagnosis of components or devices for inverter to check if they need to be replaced.

Group	Code	Name	LCD Display	Parameter Setting	Setting Range	Unit	
PRT	89	CAP, FAN replacement warning	Inverter State		Bit	00-10	Bit
					00	-	
					01	CAP Warning	
					10	FAN Warning	

6.3.7 Operation Mode on Option Card Trip

Option card trips may occur when an option card is used with the inverter. Set the operation mode for the inverter when a communication error occurs between the option card and the inverter body, or when the option card is detached during operation.

Group	Code	Name	LCD Display	Parameter Setting	Setting range	Unit	
Pr	80	Operation mode on option card trip	Opt Trip Mode	0	None	0-3	-
				1	Free-Run		
				2	Dec		

Operation Mode on Option Trip Setting Details

Code	Description	
Pr.80 Opt Trip Mode	Setting	Function
	0	None No operation
	1	Free-Run The inverter output is blocked and fault trip information is shown on the keypad.
	2	Dec The motor decelerates to the value set at Pr.07 (Trip Dec Time).

6.3.8 No Motor Trip

If an operation command is run when the motor is disconnected from the inverter output terminal, a 'no motor trip' occurs and a protective operation is performed by the system.

Group	Code	Name	LCD Display	Parameter Setting		Setting range	Unit
Pr	31	Operation on no motor trip	No Motor Trip	0	None	-	-
	32	No motor trip current level	No Motor Level	5		1-100	%
	33	No motor detection time	No Motor Time	3.0		0.1-10	s

No Motor Trip Setting Details

Code	Description
Pr.32 No Motor Level, Pr.33 No Motor Time	If the output current value [based on the rated current (bA.13)] is lower than the value set at Pr.32 (No Motor Level), and if this continues for the time set at Pr.33 (No Motor Time), a 'no motor trip' occurs.

Caution

If bA.07 (V/F Pattern) is set to 1 (Square), set Pr.32 (No Motor Level) to a value lower than the factory default. Otherwise, 'no motor trip' due to a lack of output current will result when the 'no motor trip' operation is set.

6.3.9 Low voltage trip 2

If you set the Pr-82(LV2 Selection) code to Yes (1), the trip notification is displayed when a low voltage trip occurs. In this case, even if the voltage of the DC Link condenser is higher than the trip level, the LV2 trip will not be retrieved. To retrieve the trip, reset the inverter. The trip history will not be saved.

Group	Code	Name	LCD Display	Parameter Setting	Setting Range	Unit
Pr	82	LV2 Selection	LV2 Enable	Yes(1)	0/1	-

6.4 Fault/Warning List

The following list shows the types of faults and warnings that can occur while using the S100 inverter. Please refer to [6 Learning Protection Features](#) on page 197 for details about faults and warnings.

Category		LCD Display	Details
Major fault	Latch type	Over Current1	Over current trip
		Over Voltage	Over voltage trip
		External Trip	Trip due to an external signal
		NTC Open	Temperature sensor fault trip
		Over Current2	ARM short current fault trip
		Option Trip-x*	Option fault trip*
		Over Heat	Over heat fault trip
		Out Phase Open	Output open-phase fault trip
		In Phase Open	Input open-phase fault trip
		Inverter OLT	Inverter overload fault trip
		Ground Trip	Ground fault trip
		Fan Trip	Fan fault trip
		E-Thermal	Motor overheat fault trip
		Pre-PID Fail	Pre-PID operation failure
		IO Board Trip	IO Board connection fault trip
		Ext-Brake	External brake fault trip
		No Motor Trip	No motor fault trip
		Low Voltage 2	Low voltage fault trip during operation
	ParaWrite Trip**	Write parameter fault trip	
	Level type	Low Voltage	Low voltage fault trip
BX		Emergency stop fault trip	
Lost Command		Command loss trip	
Safety A(B) Err		Safety A(B) contact trip	
Hardware damage	EEP Err	External memory error	
	ADC Off Set	Analog input error	
	Watch Dog-1	CPU Watch Dog fault trip	
	Watch Dog-2		
Minor fault	Over Load	Motor overload fault trip	
	Under Load	Motor underload fault trip	
Warning	Lost Command	Command loss fault trip warning	
	Over Load	Overload warning	
	Under Load	Under load warning	

Category	LCD Display	Details
	Inverter OLT	Inverter overload warning
	Fan Warning	Fan operation warning
	DB Warn %ED	Braking resistor braking rate warning
	Retry Tr Tune	Rotor time constant tuning error
	CAP Exchange	Capacitor replacement warning
	FAN Exchange	Fan replacement warning

* Applies only when an option board is used.

** Displayed on an LCD keypad only.

7 RS-485 Communication Features

This section in the user manual explains how to control the inverter with a PLC or a computer over a long distance using the RS-485 communication features. To use the RS-485 communication features, connect the communication cables and set the communication parameters on the inverter. Refer to the communication protocols and parameters to configure and use the RS-485 communication features.

7.1 Communication Standards

Following the RS-485 communication standards, S100 products exchange data with a PLC and computer. The RS-485 communication standards support the Multi-drop Link System and offer an interface that is strongly resistant to noise. Please refer to the following table for details about the communication standards.

Item	Standard
Communication method/ Transmission type	RS-485/Bus type, Multi-drop Link System
Inverter type name	S100
Number of connected inverters/ Transmission distance	Maximum of 16 inverters / Maximum 1,200m (recommended distance: within 700m)
Recommended cable size	0.75mm ² , (18AWG), Shielded Type Twisted-Pair (STP) Wire
Installation type	Dedicated terminals (S+/S-/SG) on the control terminal block
Power supply	Supplied by the inverter - insulated power source from the inverter's internal circuit
Communication speed	1,200/2,400/9,600/19,200/38,400/57,600/115,200 bps
Control procedure	Asynchronous communications system
Communication system	Half duplex system
Character system	Modbus-RTU: Binary / LS Bus: ASCII
Stop bit length	1-bit/2-bit
Frame error check	2 bytes
Parity check	None/Even/Odd

7.2 Communication System Configuration

In an RS-485 communication system, the PLC or computer is the master device and the inverter is the slave device. When using a computer as the master, the RS-232 converter must be integrated

with the computer, so that it can communicate with the inverter through the RS-232/RS-485 converter. Specifications and performance of converters may vary depending on the manufacturer, but the basic functions are identical. Please refer to the converter manufacturer's user manual for details about features and specifications.

Connect the wires and configure the communication parameters on the inverter by referring to the following illustration of the communication system configuration.

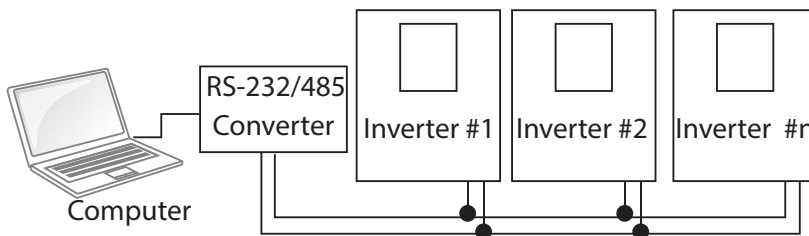

7.2.1 Communication Line Connection

Make sure that the inverter is turned off completely, and then connect the RS-485 communication line to the S+/S-/SG terminals of the terminal block. The maximum number of inverters you can connect is 16. For communication lines, use shielded twisted pair (STP) cables.

The maximum length of the communication line is 1,200 meters, but it is recommended to use no more than 700 meters of communication line to ensure stable communication. Please use a repeater to enhance the communication speed when using a communication line longer than 1,200 meters or when using a large number of devices. A repeater is effective when smooth communication is not available due to noise interference.

CAUTION

When wiring the communication line, make sure that the SG terminals on the PLC and inverter are connected. SG terminals prevent communication errors due to electronic noise interference.

7.2.2 Setting Communication Parameters

Before proceeding with setting communication configurations, make sure that the communication lines are connected properly. Turn on the inverter and set the communication parameters.

Group	Code	Name	LCD Display	Parameter Setting	Setting range	Unit
CM	01	Built-in communication inverter ID	Int485 St ID	1	1-250	-
	02	Built-in communication protocol	Int485 Proto	0 ModBus RTU	0, 2	-
	03	Built-in communication speed	Int485 BaudR	3 9600 bps	0-7	-
	04	Built-in communication frame setting	Int485 Mode	0 D8/PN/S1	0-3	-
	05	Transmission delay after reception	Resp Delay	5	0-1000	ms

Communication Parameters Setting Details

Code	Description																		
CM.01 Int485 St ID	Set the inverter station ID between 1 and 250.																		
CM.02 Int485 Proto	Select one of the two built-in protocols: Modbus-RTU or LS INV 485.																		
	<table border="1"> <thead> <tr> <th>Setting</th> <th>Function</th> </tr> </thead> <tbody> <tr> <td>0 Modbus-RTU</td> <td>Modbus-RTU compatible protocol</td> </tr> <tr> <td>2 LS INV 485</td> <td>Dedicated protocol for the LS inverter</td> </tr> </tbody> </table>	Setting	Function	0 Modbus-RTU	Modbus-RTU compatible protocol	2 LS INV 485	Dedicated protocol for the LS inverter												
	Setting	Function																	
0 Modbus-RTU	Modbus-RTU compatible protocol																		
2 LS INV 485	Dedicated protocol for the LS inverter																		
CM.03 Int485 BaudR	Set a communication setting speed up to 115,200 bps.																		
CM.04 Int485 Mode	<table border="1"> <thead> <tr> <th>Setting</th> <th>Function</th> </tr> </thead> <tbody> <tr> <td>0</td> <td>1,200 bps</td> </tr> <tr> <td>1</td> <td>2,400 bps</td> </tr> <tr> <td>2</td> <td>4,800 bps</td> </tr> <tr> <td>3</td> <td>9,600 bps</td> </tr> <tr> <td>4</td> <td>19,200 bps</td> </tr> <tr> <td>5</td> <td>38,400 bps</td> </tr> <tr> <td>6</td> <td>56K bps</td> </tr> <tr> <td>7</td> <td>115 Kbps</td> </tr> </tbody> </table>	Setting	Function	0	1,200 bps	1	2,400 bps	2	4,800 bps	3	9,600 bps	4	19,200 bps	5	38,400 bps	6	56K bps	7	115 Kbps
	Setting	Function																	
	0	1,200 bps																	
	1	2,400 bps																	
	2	4,800 bps																	
	3	9,600 bps																	
	4	19,200 bps																	
	5	38,400 bps																	
6	56K bps																		
7	115 Kbps																		
Set a communication configuration. Set the data length, parity check method, and the number of stop bits.																			
<table border="1"> <thead> <tr> <th>Setting</th> <th>Function</th> </tr> </thead> <tbody> <tr> <td>0 D8/PN/S1</td> <td>8-bit data / no parity check / 1 stop bit</td> </tr> <tr> <td>1 D8/PN/S2</td> <td>8-bit data / no parity check / 2 stop bits</td> </tr> <tr> <td>2 D8/PE/S1</td> <td>8-bit data / even parity / 1 stop bit</td> </tr> <tr> <td>3 D8/PO/S1</td> <td>8-bit data / odd parity / 1 stop bit</td> </tr> </tbody> </table>	Setting	Function	0 D8/PN/S1	8-bit data / no parity check / 1 stop bit	1 D8/PN/S2	8-bit data / no parity check / 2 stop bits	2 D8/PE/S1	8-bit data / even parity / 1 stop bit	3 D8/PO/S1	8-bit data / odd parity / 1 stop bit									
Setting	Function																		
0 D8/PN/S1	8-bit data / no parity check / 1 stop bit																		
1 D8/PN/S2	8-bit data / no parity check / 2 stop bits																		
2 D8/PE/S1	8-bit data / even parity / 1 stop bit																		
3 D8/PO/S1	8-bit data / odd parity / 1 stop bit																		
CM.05 Resp Delay	Set the response time for the slave (inverter) to react to the request from the																		

Code	Description
	<p>master. Response time is used in a system where the slave device response is too fast for the master device to process. Set this code to an appropriate value for smooth master-slave communication.</p> <p>The diagram illustrates the timing between a Master and a Slave. The Master sends a 'Request' pulse. The Slave responds with a 'Response' pulse. A 'CM.5 Resp Delay' is indicated as the time interval between the end of the Master's request and the start of the Slave's response. This delay is shown for two consecutive requests.</p>

7.2.3 Setting Operation Command and Frequency

To select the built-in RS485 communication as the source of command, set the Frq code to 6 (Int485) on the keypad (basic keypad with 7-segment display). On an LCD keypad, set the DRV code to 3 (Int485). Then, set common area parameters for the operation command and frequency via communication.

Group	Code	Name	LCD Display	Parameter Setting		Setting range	Unit
Pr	12	Speed command loss operation mode	Lost Cmd Mode	1	Free-Run	0-5	-
	13	Time to determine speed command loss	Lost Cmd Time	1.0		0.1-120	s
	14	Operation frequency at speed command loss	Lost Preset F	0.00		Start frequency–Maximum frequency	Hz
OU	31	Multi-function relay 1	Relay 1	13	Lost Command	0-35	-
	33	Multi-function output 1	Q1 Define				

Group	Code	Name	LCD Display	Parameter Setting		Setting range	Unit
Operation	DRV	Command source	Cmd Source*	3	Int 485	0-4	-
	Frq	Frequency setting method	Freq Ref Src	6	Int 485	0-12	-

* Displayed in DRV-06 on an LCD keypad.

7.2.4 Command Loss Protective Operation

Configure the command loss decision standards and protective operations run when a communication problem lasts for a specified period of time.

Command Loss Protective Operation Setting Details

Code	Description	
Pr.12 Lost Cmd Mode, Pr.13 Lost Cmd Time	Select the operation to run when a communication error has occurred and lasted exceeding the time set at Pr. 13.	
	Setting	Function
	0	None The speed command immediately becomes the operation frequency without any protection function.
	1	Free-Run The inverter blocks output. The motor performs in free-run condition.
	2	Dec The motor decelerates and then stops at the time set at Pr.07 (Trip Dec Time).
	3	Hold Input The inverter calculates the average input value for 10 seconds before the loss of the speed command and uses it as the speed reference.
	4	Hold Output The inverter calculates the average output value for 10 seconds before the loss of the speed command and uses it as the speed reference.
	5	Lost Preset The inverter operates at the frequency set at Pr. 14 (Lost Preset F).

7.2.5 Setting Virtual Multi-Function Input

Multi-function input can be controlled using a communication address (0h0385). Set codes CM.70–77 to the functions to operate, and then set the BIT relevant to the function to 1 at 0h0322 to operate it. Virtual multi-function operates independently from In.65-71 analog multi-function inputs and cannot be set redundantly. Virtual multi-function input can be monitored using CM.86 (Virt DI Status). Before you configure the virtual multi-function inputs, set the DRV code according to the command source.

Group	Code	Name	LCD Display	Parameter Setting		Setting range	Unit
CM	70-77	Communication multi-function input x	Virtual DI x (x: 1-8)	0	None	0-49	-
	86	Communication multi-function input monitoring	Virt DI Status	-	-	-	-

Example: When sending an Fx command by controlling virtual multi-function input in the common area via Int485, set CM.70 to FX and set address 0h0322 to 0h0001.

Note

The following are values and functions that are applied to address 0h0322:

Setting	Function
0h0001	Forward operation (Fx)
0h0003	Reverse operation (Rx)
0h0000	Stop

7.2.6 Saving Parameters Defined by Communication

If you turn off the inverter after setting the common area parameters or keypad parameters via communication and operate the inverter, the changes are lost and the values changed via communication revert to the previous setting values when you turn on the inverter.

Set CNF-48 to 1 (Yes) to allow all the changes over communication to be saved, so that the inverter retains all the existing values even after the power has been turned off.

Setting address 0h03E0 to 0 and then setting it again to 1 via communication allows the existing parameter settings to be saved. However, setting address 0h03E0 to 1 and then setting it to 0 does not carry out the same function. Parameters defined by communication can only be saved using an LCD keypad.

Group	Code	Name	LCD Display	Parameter Setting		Setting range	Unit
CNF*	48	Save parameters	Parameter Save	0	No	0-1	-
				1	Yes		

*Available on an LCD keypad only.

7.2.7 Total Memory Map for Communication

Communication Area	Memory Map	Details
Communication common compatible area	0h0000-0h00FF	iS5, iP5A, iV5, iG5A compatible area
Parameter registration type area	0h0100-0h01FF	Areas registered at CM.31–38 and CM.51–58
	0h0200-0h023F	Area registered for User Group
	0h0240-0h027F	Area registered for Macro Group
	0h0280-0h02FF	Reserved
S100 communication common area	0h0300-0h037F	Inverter monitoring area
	0h0380-0h03DF	Inverter control area
	0h03E0-0h03FF	Inverter memory control area
	0h0400-0h0FFF	Reserved
	0h1100	dr Group
	0h1200	bA Group
	0h1300	Ad Group
	0h1400	Cn Group
	0h1500	In Group
	0h1600	OU Group
	0h1700	CM Group
	0h1800	AP Group
	0h1B00	Pr Group
	0h1C00	M2 Group

7.2.8 Parameter Group for Data Transmission

By defining a parameter group for data transmission, the communication addresses registered in the communication function group (CM) can be used in communication. Parameter group for data transmission may be defined to transmit multiple parameters at once, into the communication frame.

Group	Code	Name	LCD Display	Parameter Setting		Setting range	Unit
CM	31-38	Output communication address x	Para Status-x	-	-	0000-FFFF	Hex
	51-58	Input communication address x	Para Control-x	-	-	0000-FFFF	Hex

Currently Registered CM Group Parameter

Address	Parameter	Assigned content by bit
0h0100-0h0107	Status Parameter-1- Status Parameter-8	Parameter communication code value registered at CM.31-38 (Read-only)
0h0110-0h0117	Control Parameter-1- Control Parameter-8	Parameter communication code value registered at CM.51-58 (Read/Write access)

Note

When registering control parameters, register the operation speed (0h0005, 0h0380, 0h0381) and operation command (0h0006, 0h0382) parameters at the end of a parameter control frame. For example, when the parameter control frame has 5 parameter control items (Para Control - x), register the operation speed at Para Control-4 and the operation command to Para Control-5.

7.3 Communication Protocol

The built-in RS-485 communication supports LS INV 485 and Modbus-RTU protocols.

7.3.1 LS INV 485 Protocol

The slave device (inverter) responds to read and write requests from the master device (PLC or PC).

Request

ENQ	Station ID	CMD	Data	SUM	EOT
1 byte	2 bytes	1 byte	n bytes	2 bytes	1 byte

Normal Response

ACK	Station ID	CMD	Data	SUM	EOT
1 byte	2 bytes	1 byte	n x 4 bytes	2 bytes	1 byte

Error Response

NAK	Station ID	CMD	Error code	SUM	EOT
1 byte	2 bytes	1 byte	2 bytes	2 bytes	1 byte

- A request starts with ENQ and ends with EOT.

- A normal response starts with ACK and ends with EOT.
- An error response starts with NAK and ends with EOT.
- A station ID indicates the inverter number and is displayed as a two-byte ASCII-HEX string that uses characters 0-9 and A-F.
- CMD: Uses uppercase characters (returns an IF error if lowercase characters are encountered)—please refer to the following table.

Character	ASCII-HEX	Command
'R'	52h	Read
'W'	57h	Write
'X'	58h	Request monitor registration
'Y'	59h	Perform monitor registration

- Data: ASCII-HEX (for example, when the data value is 3000: 3000 → '0'B'B'8'h → 30h 42h 42h 38h)
- Error code: ASCII-HEX (refer to [7.3.1.4 Error Code](#) on page 230)
- Transmission/reception buffer size: Transmission=39 bytes, Reception=44 bytes
- Monitor registration buffer: 8 Words
- SUM: Checks communication errors via sum.
SUM=a total of the lower 8 bits values for station ID, command and data (Station ID+CMD+Data) in ASCII-HEX.
For example, a command to read 1 address from address 3000:
SUM='0'+ '1'+ 'R'+ '3'+ '0'+ '0'+ '0'+ '1' = 30h+31h+52h+33h+30h+30h+30h+31h = **1A7h** (the control value is not included: ENQ, ACK, NAK, etc.).

ENQ	Station ID	CMD	Address	Number of Addresses	SUM	EOT
05h	'01'	'R'	'3000'	'1'	'A7'	04h
1 byte	2 bytes	1 byte	4 bytes	1 byte	2 bytes	1 byte

Note

Broadcasting

Broadcasting sends commands to all inverters connected to the network simultaneously. When commands are sent from station ID 255, each inverter acts on the command regardless of the station ID. However no response is issued for commands transmitted by broadcasting.

7.3.1.1 Detailed Read Protocol

Read Request: Reads successive n words from address XXXX.

ENQ	Station ID	CMD	Address	Number of Addresses	SUM	EOT
05h	'01'-FA'	'R'	'XXXX'	'1'-8'= n	'XX'	04h
1 byte	2 bytes	1 byte	4 bytes	1 byte	2 bytes	1 byte

Total bytes=12. Characters are displayed inside single quotation marks(').

Read Normal Response

ACK	Station ID	CMD	Data	SUM	EOT
06h	'01'-FA'	'R'	'XXXX'	'XX'	04h
1 byte	2 bytes	1 byte	n x 4 bytes	2 bytes	1 byte

Total bytes= (7 x n x 4): a maximum of 39

Read Error Response

NAK	Station ID	CMD	Error code	SUM	EOT
15h	'01'-FA'	'R'	'**'	'XX'	04h
1 byte	2 bytes	1 byte	2 bytes	2 bytes	1 byte

Total bytes=9

7.3.1.2 Detailed Write Protocol

Write Request: Writes successive n words to address XXXX.

ENQ	Station ID	CMD	Address	Number of Addresses	Data	SUM	EOT
05h	'01'-FA'	'W'	'XXXX'	'1'-8'= n	'XXXX...'	'XX'	04h
1 byte	2 bytes	1 byte	4 bytes	1 byte	n x 4 bytes	2 bytes	1 byte

Total bytes= (12 + n x 4): a maximum of 44

Write Normal Response

ACK	Station ID	CMD	Data	SUM	EOT
06h	'01'-FA'	'W'	'XXXX...'	'XX'	04h
1 byte	2 bytes	1 byte	n x 4 bytes	2 bytes	1 byte

Total bytes= (7 + n x 4): a maximum of 39

Write Error Response

NAK	Station ID	CMD	Error Code	SUM	EOT
15h	'01'-FA'	'W'	'**'	'XX'	04h
1 byte	2 bytes	1 byte	2 bytes	2 bytes	1 byte

Total bytes=9

7.3.1.3 Monitor Registration Detailed Protocol

Monitor registration request is made to designate the type of data that requires continuous monitoring and periodic updating.

Monitor Registration Request: Registration requests for n addresses (where n refers to the number of addresses. The addresses do not have to be contiguous.)

ENQ	Station ID	CMD	Number of Addresses	Address	SUM	EOT
05h	'01'-FA'	'X'	'1'-8'=n	'XXXX...'	'XX'	04h
1 byte	2 bytes	1 byte	1 byte	n x 4 bytes	2 bytes	1 byte

Total bytes= (8 + $n \times 4$): a maximum of 40

Monitor Registration Normal Response

ACK	Station ID	CMD	SUM	EOT
06h	'01'-FA'	'X'	'XX'	04h
1 byte	2 bytes	1 byte	2 bytes	1 byte

Total bytes=7

Monitor Registration Error Response

NAK	Station ID	CMD	Error Code	SUM	EOT
15h	'01'-FA'	'X'	'**'	'XX'	04h
1 byte	2 bytes	1 byte	2 bytes	2 bytes	1 byte

Total bytes=9

Monitor Registration Perform Request: A data read request for a registered address, received from a monitor registration request

ENQ	Station ID	CMD	SUM	EOT
05h	'01'-FA'	'Y'	'XX'	04h

ENQ	Station ID	CMD	SUM	EOT
1 byte	2 bytes	1 byte	2 bytes	1 byte

Total bytes=7

Monitor Registration Execution Normal Response

ACK	Station ID	CMD	Data	SUM	EOT
06h	'01'-'FA'	'Y'	'XXXX...'	'XX'	04h
1 byte	2 bytes	1 byte	n x 4 bytes	2 bytes	1 byte

Total bytes= (7 + n x 4): a maximum of 39

Monitor Registration Execution Error Response

NAK	Station ID	CMD	Error Code	SUM	EOT
15h	'01'-'FA'	'Y'	'**'	'XX'	04h
1 byte	2 bytes	1 byte	2 bytes	2 bytes	1 byte

Total bytes=9

7.3.1.4 Error Code

Code	Abbreviation	Description
ILLEGAL FUNCTION	IF	The requested function cannot be performed by a slave because the corresponding function does not exist.
ILLEGAL DATA ADDRESS	IA	The received parameter address is invalid at the slave.
ILLEGAL DATA VALUE	ID	The received parameter data is invalid at the slave.
WRITE MODE ERROR	WM	Tried writing (W) to a parameter that does not allow writing (read-only parameters, or when writing is prohibited during operation)
FRAME ERROR	FE	The frame size does not match.

7.3.1.5 ASCII Code

Character	Hex	Character	Hex	Character	Hex
A	41	q	71	@	40
B	42	r	72	[5B
C	43	s	73	\	5C
D	44	t	74]	5D
E	45	u	75		5E
F	46	v	76		5F
G	47	w	77		60
H	48	x	78	{	7B

Character	Hex	Character	Hex	Character	Hex
I	49	y	79		7C
J	4A	z	7A	}	7D
K	4B	0	30	-	7E
L	4C	1	31	BEL	07
M	4D	2	32	BS	08
N	4E	3	33	CAN	18
O	4F	4	34	CR	0D
P	50	5	35	DC1	11
Q	51	6	36	DC2	12
R	52	7	37	DC3	13
S	53	8	38	DC4	14
T	54	9	39	DEL	7F
U	55	space	20	DLE	10
V	56	!	21	EM	19
W	57	"	22	ACK	06
X	58	#	23	ENQ	05
Y	59	\$	24	EOT	04
Z	5A	%	25	ESC	1B
a	61	&	26	ETB	17
b	62	'	27	ETX	03
c	63	(28	FF	0C
d	64)	29	FS	1C
e	65	*	2A	GS	1D
f	66	+	2B	HT	09
g	67	,	2C	LF	0A
h	68	-	2D	NAK	15
i	69	.	2E	NUL	00
j	6A	/	2F	RS	1E
k	6B	:	3A	S1	0F
l	6C	;	3B	SO	0E
m	6D	<	3C	SOH	01
n	6E	=	3D	STX	02
o	6F	>	3E	SUB	1A
p	70	?	3F	SYN	16
				US	1F
				VT	0B

7.3.2 Modbus-RTU Protocol

7.3.2.1 Function Code and Protocol (unit: byte)

In the following section, station ID is the value set at CM.01 (Int485 St ID), and starting address is the communication address. (starting address size is in bytes). For more information about communication addresses, refer to *7.4 Compatible Common Area Parameter* on page 235.

Function Code #03: Read Holding Register

Query Field Name	Response Field Name
Station ID	Station ID
Function(0x03)	Function (0x03)
Starting Address Hi	Byte Count
Starting Address Lo	Data Hi
# of Points Hi	Data Lo
# of Points Lo	...
CRC Lo	...
CRC Hi	Data Hi
	Data Lo
	CRC Lo
	CRC Hi

number of Points

Function Code #04: Read Input Register

Query Field Name	Response Field Name
Station ID	Station ID
Function(0x04)	Function (0x04)
Starting Address Hi	Byte Count
Starting Address Lo	Data Hi
# of Points Hi	Data Lo
# of Points Lo	...
CRC Lo	...
CRC Hi	Data Hi
	Data Lo
	CRC Lo
	CRC Hi

number of Points

Function Code #06: Preset Single Register

Query Field Name	Response Field Name
Station ID	Station ID
Function (0x06)	Function (0x06)
Starting Address Hi	Register Address Hi
Register Address Lo	Register Address Lo
Preset Data Hi	Preset Data Hi
Preset Data Lo	Preset Data Lo
CRC Lo	CRC Lo
CRC Hi	CRC Hi

Function Code #16 (hex 0h10): Preset Multiple Register

Query Field Name	Response Field Name
Station ID	Station ID
Function (0x10)	Function (0x10)
Starting Address Hi	Starting Address Hi
Starting Address Lo	Starting Address Lo
# of Register Hi	# of Register Hi
# of Register Lo	# of Register Lo
Byte Count	CRC Lo
Data Hi	CRC Hi
Data Lo	
...	
...	
Data Hi	
Data Lo	
CRC Lo	
CRC Hi	

number of Points

Exception Code

Code
01: ILLEGAL FUNCTION
02: ILLEGAL DATA ADDRESS
03: ILLEGAL DATA VALUE
06: SLAVE DEVICE BUSY

Response

Field Name
Station ID
Function*
Exception Code
CRC Lo
CRC Hi

* The function value uses the top level bit for all query values.

Example of Modbus-RTU Communication in Use

When the Acc time (Communication address 0x1103) is changed to 5.0 sec and the Dec time (Communication address 0x1104) is changed to 10.0 sec.

Frame Transmission from Master to Slave (Request)

Item	Station ID	Function	Starting Address	# of Register	Byte Count	Data 1	Data 2	CRC
Hex	0x01	0x10	0x1102	0x0002	0x04	0x0032	0x0064	0x1202
Description	CM.01 Int485 St ID	Preset Multiple Register	Starting Address -1 (0x1103-1)	-	-	50 (ACC time 5.0sec)	100 (DEC time 10.0sec)	-

Frame Transmission from Slave to Master (Response)

Item	Station ID	Function	Starting Address	# of Register	CRC
Hex	0x01	0x10	0x1102	0x0002	0xE534
Description	CM.01 Int485 St ID	Preset Multiple Register	Starting Address -1 (0x1103-1)	-	-

7.4 Compatible Common Area Parameter

The following are common area parameters compatible with iS5, iP5A, iV5, and iG5A.

Comm. Address	Parameter	Scale	Unit	R/W	Assigned Content by Bit	
0h0000	Inverter model	-	-	R	6: S100	
0h0001	Inverter capacity	-	-	R	0: 0.75 kW, 1: 1.5 kW, 2: 2.2 kW 3: 3.7 kW, 4: 5.5 kW, 5: 7.5 kW 6: 11 kW, 7: 15 kW, 8: 18.5 kW 9: 22 kW 256: 0.4 kW, 257: 1.1 kW, 258: 3.0 kW 259: 4.0 kW	
0h0002	Inverter input voltage	-	-	R	0: 220V product 1: 440V product	
0h0003	Version	-	-	R	Example 0h0100: Version 1.00 Example 0h0101: Version 1.01	
0h0004	Reserved	-	-	R/W		
0h0005	Command frequency	0.01	Hz	R/W		
0h0006	Operation command (option)	-	-	R	B15	Reserved
					B14	0: Keypad Freq,
					B13	1: Keypad Torq
					B12	2-16: Terminal block multi-step speed
					B11	17: Up, 18: Down
					B10	19: STEADY
					B9	22: V1, 24: V2, 25: I2, 26: Reserved 27: Built-in 485 28: Communication option 30: JOG, 31: PID
				B8	0: Keypad	
				B7	1: Fx/Rx-1	
				B6	2: Fx/Rx-2 3: Built-in 485 4: Communication option	
				R/W	B5	Reserved
					B4	Emergency stop
					B3	W: Trip initialization (0→1), R: Trip status
					B2	Reverse operation (R)
B1	Forward operation (F)					
B0	Stop (S)					
0h0007	Acceleration time	0.1	s	R/W	-	

RS-485 Communication Features

Comm. Address	Parameter	Scale	Unit	R/W	Assigned Content by Bit	
0h0008	Deceleration time	0.1	s	R/W	-	
0h0009	Output current	0.1	A	R	-	
0h000A	Output frequency	0.01	Hz	R	-	
0h000B	Output voltage	1	V	R	-	
0h000C	DC link voltage	1	V	R	-	
0h000D	Output power	0.1	kW	R	-	
0h000E	Operation status	-	-	R	B15	0: Remote, 1: Keypad Local
					B14	1: Frequency command source by communication (built-in, option)
					B13	1: Operation command source by communication (built-in, option)
					B12	Reverse operation command
					B11	Forward operation command
					B10	Brake release signal
					B9	Jog mode
					B8	Drive stopped.
					B7	DC Braking
					B6	Speed reached
					B5	Decelerating
					B4	Accelerating
					B3	Fault Trip - operates according to Pr.30 setting
					B2	Operating in reverse direction
B1	Operating in forward direction					
B0	Stopped					
0h000F	Fault trip information	-	-	R	B15	Reserved
					B14	Reserved
					B13	Reserved
					B12	Reserved
					B11	Reserved
					B10	H/W-Diag
					B9	Reserved
					B8	Reserved
					B7	Reserved
					B6	Reserved
					B5	Reserved
					B4	Reserved
					B3	Level Type trip
					B2	Reserved
B1	Reserved					
B0	Latch Type trip					

Comm. Address	Parameter	Scale	Unit	R/W	Assigned Content by Bit	
0h0010	Input terminal information	-	-	R	B15-B7	Reserved
					B6	P7
					B5	P6
					B4	P5
					B3	P4
					B2	P3
					B1	P2
					B0	P1
0h0011	Output terminal information	-	-	R	B15	Reserved
					B14	Reserved
					B13	Reserved
					B12	Reserved
					B11	Reserved
					B10	Reserved
					B9	Reserved
					B8	Reserved
					B7	Reserved
					B6	Reserved
					B5	Reserved
					B4	Reserved
					B3	Reserved
					B2	Reserved
B1	MO					
B0	Relay 1					
0h0012	V1	0.01	%	R	V1 input voltage	
0h0013	V2	0.01	%	R	V2 input voltage	
0h0014	I2	0.01	%	R	I2 input current	
0h0015	Motor rotation speed	1	rpm	R	Displays existing motor rotation speed	
0h0016 - 0h0019	Reserved	-	-	-	-	
0h001A	Select Hz/rpm	-	-	R	0: Hz unit, 1: rpm unit	
0h001B	Display the number of poles for the selected motor	-	-	R	Display the number of poles for the selected motor	

7.5 S100 Expansion Common Area Parameter

7.5.1 Monitoring Area Parameter (Read Only)

Comm.	Address	Parameter	Scale	Unit	Assigned content by bit
0h0300		Inverter model	-	-	S100: 0006h
0h0301		Inverter capacity	-	-	0.4 kW: 1900h, 0.75 kW: 3200h 1.1 kW: 4011h, 1.5 kW: 4015h 2.2 kW: 4022h, 3.0 kW: 4030h 3.7 kW: 4037h, 4.0 kW: 4040h 5.5 kW: 4055h, 7.5 kW: 4075h 11 kW: 40B0h, 15 kW: 40F0h 18.5 kW: 4125h, 22 kW: 4160h
0h0302		Inverter input voltage/power (Single phase, 3-phase)/cooling method	-	-	100 V single phase self cooling: 0120h, 200 V 3-phase forced cooling: 0231h 100 V single phase forced cooling: 0121h, 400 V single phase self cooling: 0420h 200 V single phase self cooling: 0220h, 400 V 3-phase self cooling: 0430h 200 V 3-phase self cooling: 0230h, 400 V single phase forced cooling: 0421h 200 V single phase forced cooling: 0221h, 400 V 3-phase forced cooling: 0431h
0h0303		Inverter S/W version	-	-	(Ex) 0h0100: Version 1.00 0h0101: Version 1.01
0h0304		Reserved	-	-	-
0h0305		Inverter operation state	-	-	B15 0: Normal state B14 4: Warning occurred B13 8: Fault occurred [operates according to Pr. 30 (Trip Out Mode) setting.] B12 B11 - B8 B7 1: Speed searching B6 2: Accelerating B5 3: Operating at constant rate 4: Decelerating

Comm. Address	Parameter	Scale	Unit	Assigned content by bit	
				B4	5: Decelerating to stop 6: H/W OCS 7: S/W OCS 8: Dwell operating
				B3	0: Stopped
				B2	1: Operating in forward direction
				B1	2: Operating in reverse direction
				B0	3: DC operating (0 speed control)
0h0306	Inverter operation frequency command source	-	-	B15	Operation command source
				B14	0: Keypad
				B13	1: Communication option
				B12	3: Built-in RS 485
				B11	4: Terminal block
				B10	
				B9	
				B8	
				B7	Frequency command source
				B6	0: Keypad speed
				B5	1: Keypad torque
				B4	2-4: Up/Down operation speed
				B3	5: V1, 7: V2, 8: I2
				B2	9: Pulse
				B1	10: Built-in RS 485
				B0	11: Communication option 13: Jog 14: PID 25-39: Multi-step speed frequency
0h0307	LCD keypad S/W version	-	-	(Ex.) 0h0100: Version 1.00	
0h0308	LCD keypad title version	-	-	(Ex.) 0h0101: Version 1.01	
0h0309-0h30F	Reserved	-	-	-	
0h0310	Output current	0.1	A	-	
0h0311	Output frequency	0.01	Hz	-	
0h0312	Output rpm	0	rpm	-	
0h0313	Motor feedback speed	0	rpm	-32768 rpm-32767 rpm (directional)	
0h0314	Output voltage	1	V	-	
0h0315	DC Link voltage	1	V	-	
0h0316	Output power	0.1	kW	-	
0h0317	Output torque	0.1	%	-	
0h0318	PID reference	0.1	%	-	

Comm. Address	Parameter	Scale	Unit	Assigned content by bit	
0h0319	PID feedback	0.1	%	-	
0h031A	Display the number of poles for the 1 st motor	-	-	Displays the number of poles for the first motor	
0h031B	Display the number of poles for the 2 nd motor	-	-	Displays the number of poles for the 2nd motor	
0h031C	Display the number of poles for the selected motor	-	-	Displays the number of poles for the selected motor	
0h031D	Select Hz/rpm	-	-	0: Hz, 1: rpm	
0h031E - 0h031F	Reserved	-	-	-	
0h0320	Digital input information			B15	Reserved
				-	-
				B7	Reserved
				B6	P7(I/O board)
				B5	P6(I/O board)
				B4	P5(I/O board)
				B3	P4(I/O board)
				B2	P3(I/O board)
				B1	P2(I/O board)
B0	P1(I/O board)				
0h0321	Digital output information			B15	Reserved
				-	Reserved
				B4	Reserved
				B3	Reserved
				B2	Reserved
				B1	Q1
B0	Relay 1				
0h0322	Virtual digital input information			B15	Reserved
				-	Reserved
				B8	Reserved
				B7	Virtual DI 8(CM.77)
				B6	Virtual DI 7(CM.76)
				B5	Virtual DI 6(CM.75)
				B4	Virtual DI 5(CM.74)
				B3	Virtual DI 4(CM.73)
				B2	Virtual DI 3(CM.72)
B1	Virtual DI 2(CM.71)				
B0	Virtual DI 1(CM.70)				
0h0323	Display the selected motor	-	-	0: 1st motor/1: 2nd motor	

Comm. Address	Parameter	Scale	Unit	Assigned content by bit	
0h0324	AI1	0.01	%	Analog input V1 (I/O board)	
0h0325	Reserved	0.01	%		
0h0326	AI3	0.01	%	Analog input V2 (I/O board)	
0h0327	AI4	0.01	%	Analog input I2 (I/O board)	
0h0328	AO1	0.01	%	Analog output 1 (I/O board)	
0h0329	AO2	0.01	%	Analog output 2 (I/O board)	
0h032A	AO3	0.01	%	Reserved	
0h032B	AO4	0.01	%	Reserved	
0h032C	Reserved	-	-	-	
0h032D	Reserved	-	-	-	
0h032E	Reserved	-	-	-	
0h032F	Reserved	-	-	-	
0h0330	Latch type trip information - 1	-	-	B15	Fuse Open Trip
				B14	Over Heat Trip
				B13	Arm Short
				B12	External Trip
				B11	Overvoltage Trip
				B10	Overcurrent Trip
				B9	NTC Trip
				B8	Reserved
				B7	Reserved
				B6	Input open-phase trip
				B5	Output open-phase trip
				B4	Ground Fault Trip
				B3	E-Thermal Trip
				B2	Inverter Overload Trip
0h0331	Latch type trip information - 2	-	-	B1	Underload Trip
				B0	Overload Trip
				B15	Reserved
				B14	Reserved
				B13	Safety option to block inverter output at the terminal block input (only for products rated at 90 kW and above).
				B12	Reserved
				B11	Reserved
				B10	Bad option card
				B9	No motor trip
				B8	External brake trip
B7	Bad contact at basic I/O board				
B6	Pre PID Fail				
B5	Error while writing parameter				
B4	Reserved				

Comm. Address	Parameter	Scale	Unit	Assigned content by bit	
				B3	FAN Trip
				B2	PTC (Thermal sensor) Trip
				B1	Reserved
				B0	MC Fail Trip
0h0332	Level type trip information	-	-	B15	Reserved
				-	-
				B8	Reserved
				B7	Reserved
				B6	Reserved
				B5	SafetyB
				B4	SafetyA
				B3	Keypad Lost Command
				B2	Lost Command
				B1	LV
B0	BX				
0h0333	H/W Diagnosis Trip information	-	-	B15	Reserved
				-	Reserved
				B6	Reserved
				B5	Queue Full
				B4	Reserved
				B3	Watchdog-2 error
				B2	Watchdog-1 error
				B1	EEPROM error
B0	ADC error				
0h0334	Warning information	-	-	B15	Reserved
				-	Reserved
				B10	Reserved
				B9	Auto Tuning failed
				B8	Keypad lost
				B7	Encoder disconnection
				B6	Wrong installation of encoder
				B5	DB
				B4	FAN running
				B3	Lost command
				B2	Inverter Overload
B1	Underload				
B0	Overload				
0h0335-0h033F	Reserved	-	-	-	-

Comm. Address	Parameter	Scale	Unit	Assigned content by bit
0h0340	On Time date	0	Day	Total number of days the inverter has been powered on
0h0341	On Time minute	0	Min	Total number of minutes excluding the total number of On Time days
0h0342	Run Time date	0	Day	Total number of days the inverter has driven the motor
0h0343	Run Time minute	0	Min	Total number of minutes excluding the total number of Run Time days
0h0344	Fan Time date	0	Day	Total number of days the heat sink fan has been running
0h0345	Fan Time minute	0	Min	Total number of minutes excluding the total number of Fan Time days
0h0346 -0h0348	Reserved	-	-	-
0h0349	Reserved	-	-	-
0h034A	Option 1	-	-	0: None, 9: CANopen
0h034B	Reserved	-	-	
0h034C	Reserved			

7.5.2 Control Area Parameter (Read/ Write)

Comm. Address	Parameter	Scale	Unit	Assigned Content by Bit	
0h0380	Frequency command	0.01	Hz	Command frequency setting	
0h0381	RPM command	1	rpm	Command rpm setting	
0h0382	Operation command	-	-	B7	Reserved
				B6	Reserved
				B5	Reserved
				B4	Reserved
				B3	0 → 1: Free-run stop
				B2	0 → 1: Trip initialization
				B1	0: Reverse command, 1: Forward command
				B0	0: Stop command, 1: Run command
Example: Forward operation command 0003h, Reverse operation command 0001h					
0h0383	Acceleration time	0.1	s	Acceleration time setting	

Comm. Address	Parameter	Scale	Unit	Assigned Content by Bit	
0h0384	Deceleration time	0.1	s	Deceleration time setting	
0h0385	Virtual digital input control (0: Off, 1:On)	-	-	B15	Reserved
				-	Reserved
				B8	Reserved
				B7	Virtual DI 8(CM.77)
				B6	Virtual DI 7(CM.76)
				B5	Virtual DI 6(CM.75)
				B4	Virtual DI 5(CM.74)
				B3	Virtual DI 4(CM.73)
				B2	Virtual DI 3(CM.72)
				B1	Virtual DI 2(CM.71)
B0	Virtual DI 1(CM.70)				
0h0386	Digital output control (0:Off, 1:On)	-	-	B15	Reserved
				B14	Reserved
				B13	Reserved
				B12	Reserved
				B11	Reserved
				B10	Reserved
				B9	Reserved
				B8	Reserved
				B7	Reserved
				B6	Reserved
				B5	Reserved
				B4	Reserved
				B3	Reserved
				B2	Reserved
B1	Q1 (I/O board, OU.33: None)				
B0	Relay 1 (I/O board, OU.31: None)				
0h0387	Reserved	-	-	Reserved	
0h0388	PID reference	0.1	%	PID reference command	
0h0389	PID feedback value	0.1	%	PID feedback value	
0h038A	Motor rated current	0.1	A	-	
0h038B	Motor rated voltage	1	V	-	
0h038C-0h038F	Reserved			-	
0h0390	Torque Ref	0.1	%	Torque command	
0h0391	Fwd Pos Torque Limit	0.1	%	Forward motoring torque limit	
0h0392	Fwd Neg Torque Limit	0.1	%	Forward regenerative torque limit	

Comm. Address	Parameter	Scale	Unit	Assigned Content by Bit
0h0393	Rev Pos Torque Limit	0.1	%	Reverse motoring torque limit
0h0394	Rev Neg Torque Limit	0.1	%	Reverse regenerative torque limit
0h0395	Torque Bias	0.1	%	Torque bias
0h0396- 0h399	Reserved	-	-	-
0h039A	Anytime Para	-	-	Set the CNF.20* value (refer to 5.36 Operation State Monitor on page 193)
0h039B	Monitor Line-1	-	-	Set the CNF.21* value (refer to 5.36 Operation State Monitor on page 193)
0h039C	Monitor Line-2	-	-	Set the CNF.22* value (refer to 5.36 Operation State Monitor on page 193)
0h039D	Monitor Line-3	-	-	Set the CNF.23* value (refer to 5.36 Operation State Monitor on page 193)

* Displayed on an LCD keypad only.

Note

A frequency set via communication using the common area frequency address (0h0380, 0h0005) is not saved even when used with the parameter save function. To save a changed frequency to use after a power cycle, follow these steps:

- 1 Set dr.07 to Keypad-1 and select a random target frequency.
- 2 Set the frequency via communication into the parameter area frequency address (0h1101).
- 3 Perform the parameter save (0h03E0: '1') before turning off the power. After the power cycle, the frequency set before turning off the power is displayed.

7.5.3 Inverter Memory Control Area Parameter (Read and Write)

Comm. Address	Parameter	Scale	Unit	Changeable During Operation	Function
0h03E0	Save parameters	-	-	X	0: No, 1:Yes
0h03E1	Monitor mode initialization	-	-	O	0: No, 1:Yes
0h03E2	Parameter initialization	-	-	X	0: No, 1: All Grp, 2: Drv Grp 3: bA Grp, 4: Ad Grp, 5: Cn Grp 6: In Grp, 7: OU Grp, 8: CM Grp 9: AP Grp, 12: Pr Grp, 13: M2 Grp Setting is prohibited during fault trip interruptions.

Comm. Address	Parameter	Scale	Unit	Changeable During Operation	Function
0h03E3	Display changed parameters	-	-	0	0: No, 1: Yes
0h03E4	Reserved	-	-	-	-
0h03E5	Delete all fault history	-	-	0	0: No, 1: Yes
0h03E6	Delete user-registered codes	-	-	0	0: No, 1: Yes
0h03E7	Hide parameter mode	0	Hex	0	Write: 0-9999 Read: 0: Unlock, 1: Lock
0h03E8	Lock parameter mode	0	Hex	0	Write: 0-9999 Read: 0: Unlock, 1: Lock
0h03E9	Easy start on (easy parameter setup mode)	-	-	0	0: No, 1: Yes
0h03EA	Initializing power consumption	-	-	0	0: No, 1: Yes
0h03EB	Initialize inverter operation accumulative time	-	-	0	0: No, 1: Yes
0h03EC	Initialize cooling fan accumulated operation time	-	-	0	0: No, 1: Yes

Note

- When setting parameters in the inverter memory control area, the values are reflected to the inverter operation and saved. Parameters set in other areas via communication are reflected to the inverter operation, but are not saved. All set values are cleared following an inverter power cycle and revert back to its previous values. When setting parameters via communication, ensure that a parameter save is completed prior to shutting the inverter down.
- Set parameters very carefully. After setting a parameter to 0 via communication, set it to another value. If a parameter has been set to a value other than 0 and a non-zero value is entered again, an error message is returned. The previously-set value can be identified by reading the parameter when operating the inverter via communication.
- The addresses 0h03E7 and 0h03E8 are parameters for entering the password. When the password is entered, the condition will change from Lock to Unlock, and vice versa. When the same parameter value is entered continuously, the parameter is executed just once. Therefore, if the same value is entered again, change it to another value first and then re-enter the previous value. For example, if you want to enter 244 twice, enter it in the following order:

244 → 0 → 244.

Caution

It may take longer to set the parameter values in the inverter memory control area because all data is saved to the inverter. Be careful as communication may be lost during parameter setup if parameter setup is continues for an extended period of time.

8 Table of Functions

This chapter lists all the function settings for S100 series inverter. Set the parameters required according to the following references. If a set value input is out of range, the following messages will be displayed on the keyboard. In these cases, the inverter will not operate with the [ENT] key.

- Set value not allocated: **rd**
- Set value repetition (multi-function input, PID reference, PID feedback related): **OL**
- Set value not allowed (select value, V2, I2): **no**

8.1 Operation Group

The Operation group is used only in the basic keypad mode. It will not be displayed on an LCD keypad. If the LCD keypad is connected, the corresponding functions will be found in the Drive(DRV) group.

SL: Sensorless vector control (dr.09)

***O/X:** Write-enabled during operation, **7/L/A:** Keypad/LCD keypad/Common

Code	Comm. Address	Name	Keypad Display	Setting Range	Initial Value	Property*	V/F	SL	Ref.	
	0h1F00	Target frequency	0.00	0-Maximum frequency(Hz)	0.00	O/7	O	O	p.48	
-	0h1F01	Acceleration time	ACC	0.0-600.0(s)	20.0	O/7	O	O	p.86	
-	0h1F02	Deceleration time	dEC	0.0-600.0(s)	30.0	O/7	O	O	p.86	
-	0h1F03	Command source	drv	0	Keypad	1: Fx/Rx-1	X/7	O	O	p.79
				1	Fx/Rx-1					
				2	Fx/Rx-2					
				3	Int 485					
				4	Field Bus ¹					
-	0h1F04	Frequency reference source	Frq	0	Keypad-1	0: Keypad-1	X/7	O	O	p.66
				1	Keypad-2					
				2	V1					
				4	V2					
				5	I2					
				6	Int 485					

¹ Table of options are provided separately in the option manual.

Table of Functions

Code	Comm. Address	Name	Keypad Display	Setting Range		Initial Value	Property*	V/F	SL	Ref.
				8	Field Bus					
				12	Pulse					
-	0h1F05	Multi-step speed frequency 1	St1	0.00-Maximum frequency(Hz)		10.00	O/7	O	O	p.77
-	0h1F06	Multi-step speed frequency 2	St2	0.00-Maximum frequency(Hz)		20.00	O/7	O	O	p.77
-	0h1F07	Multi-step speed frequency 3	St3	0.00-Maximum frequency(Hz)		30.00	O/7	O	O	p.77
-	0h1F08	Output current	CUr				-/7	O	O	p.60
-	0h1F09	Motor revolutions per minute	Rpm				-/7	O	O	-
-	0h1F0A	Inverter direct current voltage	dCL	-		-	-/7	O	O	p.60
-	0h1F0B	Inverter output voltage	vOL				-/7	O	O	p.60
-	0h1F0C	Out of order signal	nOn				-/7	O	O	-
-	0h1F0D	Select rotation direction	drC	F	Forward run	F	O/7	O	O	-
				r	Reverse run					

8.2 Drive group (PAR→dr)

In the following table, data shaded in grey will be displayed when the related code has been selected.

SL: Sensorless vector control (dr.09)

***O/X:** Write-enabled during operation, **7/L/A:** Keypad/LCD keypad/Common

Code	Comm. Address	Name	LCD Display	Setting Range	Initial value	Property*	V/F	SL	Ref.
00	-	Jump Code	Jump Code	1-99	9	O/A	O	O	p.48
01 ²	0h1101	Target frequency	Cmd Frequency	Start frequency - Maximum frequency(Hz)	0.00	O/L	O	O	p.52
02	0h1102	Torque command	Cmd Torque	-180~180[%]	0.0	O/A	X	O	-
03 ²	0h1103	Acceleration time	Acc Time	0.0-600.0(s)	20.0	O/L	O	O	p.86
04 ²	0h1104	Deceleration time	Dec Time	0.0-600.0(s)	30.0	O/L	O	O	p.86
06 ²	0h1106	Command source	Cmd Source	0 Keypad 1 Fx/Rx-1 2 Fx/Rx-2 3 Int 485 4 Field Bus	1: Fx/Rx-1	X/L	O	O	p.79
07 ²	0h1107	Frequency reference source	Freq Ref Src	0 Keypad-1 1 Keypad-2 2 V1 4 V2 5 I2 6 Int 485 8 Field Bus 12 Pulse	0: Keypad-1	X/L	O	O	p.66
08	0h1108	Torque reference setting	Trq Ref Src	0 Keypad-1 1 Keypad-2 2 V1 4 V2 5 I2 6 Int 485 8 FieldBus 12 Pulse	0: Keypad-1	X/A	X	O	-

² Displayed when an LCD keypad is in use.

Table of Functions

Code	Comm. Address	Name	LCD Display	Setting Range	Initial value	Property*	V/F	SL	Ref.	
09	0h1109	Control mode	Control Mode	0	V/F	0: V/F	X/A	O	O	p.94 , p.134 , p.147
				2	Slip Compen					
				4	IM Sensorless					
10	0h110A	Torque Control	Torque Control	0	No	0: No	X/A	X	O	-
				1	Yes					
11	0h110B	Jog frequency	Jog Frequency	0.00, Start frequency- Maximum frequency(Hz)	10.00	O/A	O	O	p.126	
12	0h110C	Jog run acceleration time	Jog Acc Time	0.0-600.0(s)	20.0	O/A	O	O	p.126	
13	0h110D	Jog run deceleration time	Jog Dec Time	0.0-600.0(s)	30.0	O/A	O	O	p.126	
14	0h110E	Motor capacity	Motor Capacity	0: 0.2kW, 1: 0.4kW 2: 0.75kW, 3: 1.1kW 4: 1.5kW, 5: 2.2kW 6: 3.0kW, 7: 3.7kW 8: 4.0kW, 9: 5.5kW 10: 7.5kW, 11: 11.0kW 12: 15.0kW, 13: 18.5kW 14: 22.0kW, 15: 30.0kW	Varies by Motor capacity	X/A	O	O	p.144	
15	0h110F	Torque boost options	Torque Boost	0	Manual	0: Manual	X/A	O	X	-
				1	Auto					
16 ³	0h1110	Forward Torque boost	Fwd Boost	0.0-15.0(%)	2.0	X/A	O	X	p.97	
17 ³	0h1111	Reverse Torque boost	Rev Boost	0.0-15.0(%)	2.0	X/A	O	X	p.97	
18	0h1112	Base frequency	Base Freq	30.00-400.00(Hz)	60.00	X/A	O	O	p.94	

³ Displayed when dr.15 is set to 0 (Manual)

Code	Comm. Address	Name	LCD Display	Setting Range	Initial value	Property*	V/F	SL	Ref.	
19	0h1113	Start frequency	Start Freq	0.01-10.00(Hz)	0.50	X/A	O	O	p.94	
20	0h1114	Maximum frequency	Max Freq	40.00-400.00(Hz)[V/F, Slip Compen] 40.00-120.00(Hz)[IM Sensorless]	60.00	X/A	O	O	p.104	
21	0h1115	Select speed unit	Hz/Rpm Sel	0	Hz Display	0:Hz Display	O/L	O	O	p.77
				1	Rpm Display					
22 ⁴	0h1116	(+)Torque gain	(+)Trq Gain	50.0 ~ 150.0[%]	100.0	O/A	X	O	-	
23 ⁴	0h1117	(-)Torque gain	(-)Trq Gain	50.0 ~ 150.0[%]	80.0	O/A	X	O	-	
24 ⁴	0h1118	(-)Torque gain 0	(-)Trq Gain0	50.0 ~ 150.0[%]	80.0	O/A	X	O	-	
25 ⁴	0h1119	(-)Torque offset	(-)Trq Offset	0.0 ~ 100.0[%]	40.0	O/A	X	O	-	
80 ⁵	0h1150	Select ranges at power input	-	Select ranges inverter displays at power input		0:run frequency	O/7	O	O	-
				0	Run frequency					
				1	Acceleration time					
				2	Deceleration time					
				3	Command source					
				4	Frequency reference source					
				5	Multi-step speed frequency 1					
6	Multi-step speed frequency 2									

⁴ Displayed when dr.10 is set to 1 (YES)

⁵ Will not be displayed when an LCD keypad is in use

Table of Functions

Code	Comm. Address	Name	LCD Display	Setting Range	Initial value	Property*	V/F	SL	Ref.	
				7	Multi-step speed frequency 3					
				8	Output current					
				9	Motor RPM					
				10	Inverter DC voltage					
				11	User select signal (dr.81)					
				12	Currently out of order					
				13	Select run direction					
				14	output current2					
				15	Motor RPM2					
				16	Inverter DC voltage2					
				17	User select signal2 (dr.81)					
81 ⁵	0h1151	Select monitor code	-		Monitors user selected code	0: output voltage	0/7	0	0	-
				0	Output voltage(V)					
				1	Output electric power(kW)					
				2	Torque(kgf · m)					
89 ⁵	0h03E3	Display changed parameter	-	0	View All	0: View All	0/7	0	0	p.173
				1	View Changed					
90 ⁵	0h115A	[ESC] key functions	-	0	Move to initial position	0: None	X/7	0	0	p.50 , p.82 , p.128
				1	JOG Key					

Code	Comm. Address	Name	LCD Display	Setting Range		Initial value	Property*	V/F	SL	Ref.
				2	Local/Remote					
93 ⁵	0h115D	Parameter initialization	-	0	No	0:No	X/7	O	O	<u>p.170</u>
				1	All Grp					
				2	dr Grp					
				3	bA Grp					
				4	Ad Grp					
				5	Cn Grp					
				6	In Grp					
				7	OU Grp					
				8	CM Grp					
				9	AP Grp					
				12	Pr Grp					
				13	M2 Grp					
				16	run Grp					
94 ⁵	0h115E	Password registration		0-99			O/7	O	O	<u>p.171</u>
95 ⁵	0h115F	Parameter lock settings		0-99			O/7	O	O	<u>p.172</u>
97 ⁵	0h1161	Software version	-				-/7	O	O	-
98	0h1162	Display I/O board version	IO S/W Ver				-/A	O	O	-
99	0h1163	Display I/O board H/W version	IO H/W Ver	0	Multiple IO	Standard IO	-/A	O	O	-
				1	Standard IO					
				2	Standard IO (M)					

8.3 Basic Function group (PAR→bA)

In the following table, the data shaded in grey will be displayed when a related code has been selected.

SL: Sensorless vector control function (dr.09)

***O/X:** Write-enabled during operation, **7/L/A:** Keypad/LCD keypad/Common

Code	Comm. Address	Name	LCD Display	Setting Range	Initial Value	Property*	V/F	SL	Ref.	
00	-	Jump Code	Jump Code	1-99	20	O	O	O	p.48	
01	0h1201	Auxiliary reference source	Aux Ref Src	0	None	0:None	X/A	O	O	p.122
				1	V1					
				3	V2					
				4	I2					
				6	Pulse					
02 ⁶	0h1202	Auxiliary command calculation type	Aux Calc Type	0	M+(G*A)	0: M+(GA)	X/A	O	O	p.122
				1	Mx (G*A)					
				2	M/(G*A)					
				3	M+[M*(G*A)]					
				4	M+G*2(A-50%)					
				5	Mx[G*2(A-50%)					
				6	M/[G*2(A-50%)]					
				7	M+M*G*2(A-50%)					
03 ⁶	0h1203	Auxiliary command gain	Aux Ref Gain	-200.0-200.0(%)	100.0	O/A	O	O	p.122	
04	0h1204	2nd command source	Cmd 2nd Src	0	Keypad	1: Fx/Rx-1	X/A	O	O	p.106
				1	Fx/Rx-1					
				2	Fx/Rx-2					
				3	Int 485					
				4	FieldBus					
05	0h1205	2nd frequency source	Freq 2nd Src	0	Keypad-1	0: Keypad -1	O/A	O	O	p.106
				1	Keypad-2					
				2	V1					
				4	V2					
				5	I2					
				6	Int 485					
				8	FieldBus					
				12	Pulse					

⁶ Displayed if bA.01 is not set to 0 (None).

Code	Comm. Address	Name	LCD Display	Setting Range	Initial Value	Property*	V/F	SL	Ref.	
06 ⁷	0h1206	2nd Torque command source	Trq 2nd Src	0	Keypad-1	0: Keypad-1	O	X	O	
				1	Keypad-2					
				2	V1					
				4	V2					
				5	I2					
				6	Int 485					
				8	FieldBus					
				12	Pulse					
07	0h1207	V/F pattern options	V/F Pattern	0	Linear	0: Linear	X/A	O	X	p.94
				1	Square					
				2	User V/F					
				3	Square 2					
08	0h1208	Acc/dec standard frequency	Ramp T Mode	0	Max Freq	0: Max Freq	X/A	O	O	p.86
				1	Delta Freq					
09	0h1209	Time scale settings	Time Scale	0	0.01 sec	1:0.1 sec	X/A	O	O	p.86
				1	0.1 sec					
				2	1 sec					
10	0h120A	Input power frequency	60/50 Hz Sel	0	60Hz	0:60Hz	X/A	O	O	p.169
				1	50Hz					
11	0h120B	Number of motor poles	Pole Number	2-48		Dependent on motor setting	X/A	O	O	p.134
12	0h120C	Rated slip speed	Rated Slip	0-3000(Rpm)			X/A	O	O	p.134
13	0h120D	Motor rated current	Rated Curr	1.0-1000.0(A)			X/A	O	O	p.134
14	0h120E	Motor noload current	Noload Curr	0.0-1000.0(A)			X/A	O	O	p.134
15	0h120F	Motor rated voltage	Rated Volt	170-480(V)			0	X/A	O	O
16	0h1210	Motor efficiency	Efficiency	70-100(%)		Dependent on motor setting	X/A	O	O	p.134
17	0h1211	Load inertia rate	Inertia Rate	0-8			X/A	O	O	p.134
18	0h1212	Trim power display	Trim Power %	70-130(%)			O/A	O	O	-
19	0h1213	Input power voltage	AC Input Volt	170-480V		220/380V	O/A	O	O	p.169

⁷ Displayed when dr.09 is set to 4(IM Sensorless)

Table of Functions

Code	Comm. Address	Name	LCD Display	Setting Range	Initial Value	Property*	V/F	SL	Ref.	
20	-	Auto Tuning	Auto Tuning	0	None	0:None	X/A	X	O	p.144
				1	All (Rotation type)					
				2	ALL (Static type)					
				3	Rs+Lsigma (Rotation type)					
				6	Tr (Static type)					
21	-	Stator resistance	Rs	Dependent on motor setting	Dependent on motor setting	X/A	X	O	p.144	
22	-	Leakage inductance	Lsigma			X/A	X	O	p.144	
23	-	Stator inductance	Ls			X/A	X	O	p.144	
24 ⁷	-	Rotor time constant	Tr	25-5000(ms)	-	X/A	X	O	p.144	
25 ⁷	-	Stator inductance scale	Ls Scale	50 ~ 150[%]	100	X/A	X	O	=	
26 ⁷	-	Rotor time constant scale	Tr Scale	50 ~ 150[%]	100	X/A	X	O	=	
31 ⁷		Regeneration inductance scale	Ls Regen Scale	70 ~ 100[%]	80	X/A	X	O	=	
41 ⁸	0h1229	User frequency1	User Freq 1	0.00-Maximum frequency(Hz)	15.00	X/A	O	X	p.96	
42 ⁸	0h122A	User voltage1	User Volt 1	0-100(%)	25	X/A	O	X	p.96	
43 ⁸	0h122B	User frequency2	User Freq 2	0.00-0.00-Maximum frequency(Hz)	30.00	X/A	O	X	p.96	
44 ⁸	0h122C	User voltage2	User Volt 2	0-100(%)	50	X/A	O	X	p.96	
45 ⁸	0h122D	User frequency3	User Freq 3	0.00-Maximum frequency(Hz)	45.00	X/A	O	X	p.96	
46 ⁸	0h122E	User voltage3	User Volt 3	0-100(%)	75	X/A	O	X	p.96	
47 ⁸	0h122F	User frequency4	User Freq 4	0.00-Maximum frequency(Hz)	Maximum frequency	X/A	O	X	p.96	

⁸ Displayed if either bA.07 or M2.25 is set to 2 (User V/F).

Code	Comm. Address	Name	LCD Display	Setting Range	Initial Value	Property*	V/F	SL	Ref.
48 ⁸	0h1230	User voltage4	User Volt 4	0-100(%)	100	X/A	O	X	p.96
50 ⁹	0h1232	Multi-step speed frequency1	Step Freq-1	0.00-Maximum frequency(Hz)	10.00	O/L	O	O	p.77
51 ⁹	0h1233	Multi-step speed frequency2	Step Freq-2	0.00-Maximum frequency(Hz)	20.00	O/L	O	O	p.77
52 ⁹	0h1234	Multi-step speed frequency3	Step Freq-3	0.00-Maximum frequency(Hz)	30.00	O/L	O	O	p.77
53 ¹⁰	0h1235	Multi-step speed frequency4	Step Freq-4	0.00-Maximum frequency(Hz)	40.00	O/A	O	O	p.77
54 ¹⁰	0h1236	Multi-step speed frequency5	Step Freq-5	0.00-Maximum frequency(Hz)	50.00	O/A	O	O	p.77
55 ¹⁰	0h1237	Multi-step speed frequency6	Step Freq-6	0.00-Maximum frequency(Hz)	Maximum frequency	O/A	O	O	p.77
56 ¹⁰	0h1238	Multi-step speed frequency7	Step Freq-7	0.00-Maximum frequency(Hz)	Maximum frequency	O/A	O	O	p.77
70	0h1246	Multi-step acceleration time1	Acc Time-1	0.0-600.0(s)	20.0	O/A	O	O	p.88
71	0h1247	Multi-step deceleration time1	Dec Time-1	0.0-600.0(s)	20.0	O/A	O	O	p.88
72 ¹¹	0h1248	Multi-step acceleration time2	Acc Time-2	0.0-600.0(s)	30.0	O/A	O	O	p.88
73 ¹¹	0h1249	Multi-step deceleration time2	Dec Time-2	0.0-600.0(s)	30.0	O/A	O	O	p.88
74 ¹¹	0h124A	Multi-step acceleration time3	Acc Time-3	0.0-600.0(s)	40.0	O/A	O	O	p.88

⁹ Displayed when an LCD keypad is in use.

¹⁰ Displayed if one of In.65-71 is set to Speed-L/M/H

¹¹ Displayed one of In.65-71 is set to Xcel-L/M/H.

Table of Functions

Code	Comm. Address	Name	LCD Display	Setting Range	Initial Value	Property*	V/F	SL	Ref.
75 ¹¹	0h124B	Multi-step deceleration time3	Dec Time-3	0.0-600.0(s)	40.0	O/A	O	O	p.88
76 ¹¹	0h124C	Multi-step acceleration time4	Acc Time-4	0.0-600.0(s)	50.0	O/A	O	O	p.88
77 ¹¹	0h124D	Multi-step deceleration time4	Dec Time-4	0.0-600.0(s)	50.0	O/A	O	O	p.88
78 ¹¹	0h124E	Multi-step acceleration time5	Acc Time-5	0.0-600.0(s)	40.0	O/A	O	O	p.88
79 ¹¹	0h124F	Multi-step deceleration time5	Dec Time-5	0.0-600.0(s)	40.0	O/A	O	O	p.88
80 ¹¹	0h1250	Multi-step acceleration time6	Acc Time-6	0.0-600.0(s)	30.0	O/A	O	O	p.88
81 ¹¹	0h1251	Multi-step deceleration time6	Dec Time-6	0.0-600.0(s)	30.0	O/A	O	O	p.88
82 ¹¹	0h1252	Multi-step acceleration time7	Acc Time-7	0.0-600.0(s)	20.0	O/A	O	O	p.88
83 ¹¹	0h1253	Multi-step deceleration time7	Dec Time-7	0.0-600.0(s)	20.0	O/A	O	O	p.88

8.4 Expanded Function group (PAR→Ad)

In the following table, the data shaded in grey will be displayed when a related code has been selected.

SL: Sensorless vector control (dr.09)

***O/X:** Write-enabled during operation, **7/L/A:** Keypad/LCD keypad/Common

Code	Comm. Address	Name	LCD Display	Setting Range	Initial Value	Property*	V/F	SL	Ref.
00	-	Jump Code	Jump Code	1-99	24	O/A	O	O	p.48
01	0h1301	Acceleration pattern	Acc Pattern	0 Linear	0: Linear	X/A	O	O	p.91
02	0h1302	Deceleration pattern	Dec Pattern	1 S-curve		X/A	O	O	p.91
03 ¹²	0h1303	S-curve acceleration start point gradient	Acc S Start	1-100(%)	40	X/A	O	O	p.91
04 ¹²	0h1304	S-curve acceleration end point gradient	Acc S End	1-100(%)	40	X/A	O	O	p.91
05 ¹³	0h1305	S-curve deceleration start point gradient	Dec S Start	1-100(%)	40	X/A	O	O	p.91
06 ¹³	0h1306	S-curve deceleration end point gradient	Dec S End	1-100(%)	40	X/A	O	O	p.91
07	0h1307	Start Mode	Start Mode	0 Acc 1 DC-Start	0:Acc	X/A	O	O	p.99
08	0h1308	Stop Mode	Stop Mode	0 Dec 1 DC-Brake 2 Free-Run 4 Power Braking	0:Dec	X/A	O	O	p.100
09	0h1309	Selection of prohibited rotation direction	Run Prevent	0 None 1 Forward Prev 2 Reverse Prev	0: None	X/A	O	O	p.84

¹² Displayed when Ad. 01 is set to 1 (S-curve).

¹³ Displayed when Ad. 02 is set to 1 (S-curve).

Table of Functions

Code	Comm. Address	Name	LCD Display	Setting Range	Initial Value	Property*	V/F	SL	Ref.	
10	0h130A	Starting with power on	Power-on Run	0	No	0:No	O/A	O	O	p.84
				1	Yes					
12 ¹⁴	0h130C	DC braking time at startup	DC-Start Time	0.00-60.00(s)	0.00	X/A	O	O	p.99	
13	0h130D	Amount of applied DC	DC Inj Level	0-200(%)	50	X/A	O	O	p.99	
14 ¹⁵	0h130E	Output blocking time before DC braking	DC-Block Time	0.00- 60.00(s)	0.10	X/A	O	O	p.100	
15 ¹⁵	0h130F	DC braking time	DC-Brake Time	0.00- 60.00(s)	1.00	X/A	O	O	p.100	
16 ¹⁵	0h1310	DC braking rate	DC-Brake Level	0-200(%)	50	X/A	O	O	p.100	
17 ¹⁵	0h1311	DC braking frequency	DC-Brake Freq	Start frequency-60Hz	5.00	X/A	O	O	p.100	
20	0h1314	Dwell frequency on acceleration	Acc Dwell Freq	Start frequency-Maximum frequency(Hz)	5.00	X/A	O	O	p.133	
21	0h1315	Dwell operation time on acceleration	Acc Dwell Time	0.0-60.0(s)	0.0	X/A	O	O	p.133	
22	0h1316	Dwell frequency on deceleration	Dec Dwell Freq	Start frequency-Maximum frequency(Hz)	5.00	X/A	O	O	p.133	
23	0h1317	Dwell operation time on deceleration	Dec Dwell Time	0.0-60.0(s)	0.0	X/A	O	O	p.133	
24	0h1318	Frequency limit	Freq Limit	0	No	0:No	X/A	O	O	p.104
				1	Yes					
25 ¹⁶	0h1319	Frequency lower limit value	Freq Limit Lo	0.00-Upper limit frequency(Hz)	0.50	O/A	O	O	p.104	
26 ¹⁶	0h131A	Frequency upper limit value	Freq Limit Hi	Lower limit frequency-Maximum frequency(Hz)	maximum frequency	X/A	O	O	p.104	
27	0h131B	Frequency jump	Jump Freq	0	No	0:No	X/A	O	O	p.105
				1	Yes					

¹⁴ Displayed when Ad. 07 is set to 1 (DC-Start).

¹⁵ Displayed when Ad. 08 is set to 1 (DC-Brake).

¹⁶ Displayed when Ad. 24 is set to 1 (Yes).

Code	Comm. Address	Name	LCD Display	Setting Range	Initial Value	Property*	V/F	SL	Ref.	
28 ¹⁷	0h131C	Jump frequency lower limit1	Jump Lo 1	0.00-Jump frequency upper limit1(Hz)	10.00	O/A	O	O	p.105	
29 ¹⁷	0h131D	Jump frequency upper limit1	Jump Hi 1	Jump frequency lower limit1-Maximum frequency(Hz)	15.00	O/A	O	O	p.105	
30 ¹⁷	0h131E	Jump frequency lower limit2	Jump Lo 2	0.00-Jump frequency upper limit2(Hz)	20.00	O/A	O	O	p.105	
31 ¹⁷	0h131F	Jump frequency upper limit2	Jump Hi 2	Jump frequency lower limit2-Maximum frequency(Hz)	25.00	O/A	O	O	p.105	
32 ¹⁷	0h1320	Jump frequency lower limit3	Jump Lo 3	0.00-Jump frequency upper limit3(Hz)	30.00	O/A	O	O	p.105	
33 ¹⁷	0h1321	Jump frequency upper limit3	Jump Hi 3	Jump frequency lower limit3-Maximum frequency(Hz)	35.00	O/A	O	O	p.105	
41 ¹⁸	0h1329	Brake release current	BR Rls Curr	0.0-180.0(%)	50.0	O/A	O	O	p.178	
42 ¹⁸	0h132A	Brake release delay time	BR Rls Dly	0.00-10.00(s)	1.00	X/A	O	O	p.178	
44 ¹⁸	0h132C	Brake release Forward frequency	BR Rls Fwd Fr	0.00-Maximum frequency(Hz)	1.00	X/A	O	O	p.178	
45 ¹⁸	0h132D	Brake release Reverse frequency	BR Rls Rev Fr	0.00-Maximum frequency(Hz)	1.00	X/A	O	O	p.178	
46 ¹⁸	0h132E	Brake engage delay time	BR Eng Dly	0.00-10.00(s)	1.00	X/A	O	O	p.178	
47 ¹⁸	0h132F	Brake engage frequency	BR Eng Fr	0.00-Maximum frequency(Hz)	2.00	X/A	O	O	p.178	
50	0h1332	Energy saving operation	E-Save Mode	0	None	0:None	X/A	O	X	p.155
				1	Manual					
				2	Auto					
51 ¹⁹	0h1333	Energy saving level	Energy Save	0-30(%)	0	O/A	O	X	p.155	

¹⁷ Displayed when Ad. 27 is set to 1 (Yes).

¹⁸ Displayed if either OU.31 or OU.33 is set to 35 (BR Control).

¹⁹ Displayed if Ad.50 is not set to 0 (None).

Table of Functions

Code	Comm. Address	Name	LCD Display	Setting Range	Initial Value	Property*	V/F	SL	Ref.	
60	0h133C	Acc/Dec time transition frequency	Xcel Change Fr	0.00-Maximum frequency(Hz)	0.00	X/A	O	O	p.90	
64	0h1340	Cooling fan control	FAN Control	0	During Run	0:Durin g Run	O/A	O	O	p.168
				1	Always ON					
				2	Temp Control					
65	0h1341	Up/down operation frequency save	U/D Save Mode	0	No	0:No	O/A	O	O	p.129
				1	Yes					
66	0h1342	Output contact On/Off control options	On/Off Ctrl Src	0	None	0:None	X/A	O	O	p.129
				1	V1					
				3	V2					
				4	I2					
				6	Pulse					
67	0h1343	Output contact On level	On-Ctrl Level	Output contact off level-100.00%	90.00	X/A	O	O	p.179	
68	0h1344	Output contact Off level	Off-Ctrl Level	-100.00-output contact on level (%)	10.00	X/A	O	O	p.179	
70	0h1346	Safe operation selection	Run En Mode	0	Always Enable	0:Alway s Enable	X/A	O	O	p.131
				1	DI Dependent					
71 ²⁰	0h1347	Safe operation stop options	Run Dis Stop	0	Free-Run	0:Free- Run	X/A	O	O	p.131
				1	Q-Stop					
				2	Q-Stop Resume					
72 ²⁰	0h1348	Safe operation deceleration time	Q-Stop Time	0.0-600.0(s)	5.0	O/A	O	O	p.131	
74	0h134A	Selection of regeneration evasion function for press	RegenAvd Sel	0	No	0:No	X/A	O	O	p.180
				1	Yes					
75	0h134B	Voltage level of regeneration evasion motion for press	RegenAvd Level	200V : 300-400V	350	X/A	O	O	p.180	
				400V : 600-800V	700					

²⁰ Displayed when Ad.70 is set to 1 (DI Dependent).

Code	Comm. Address	Name	LCD Display	Setting Range	Initial Value	Property*	V/F	SL	Ref.	
76 ²¹	0h134C	Compensation frequency limit of regeneration evasion for press	CompFreq Limit	0.00- 10.00Hz	1.00	X/A	O	O	p.180	
77 ²¹	0h134D	Regeneration evasion for press P gain	RegenAvd Pgain	0.0- 100.0%	50.0	O/A	O	O	p.180	
78 ²¹	0h134E	Regeneration evasion for press I gain	RegenAvd I gain	20-30000(ms)	500	O/A	O	O	p.180	
80	0h1350	Fire mode selection	Fire Mode Sel	0	None	0:None	X/A	O	X	p.117
				1	Fire Mode					
				2	Fire Mode Test					
81 ²²	0h1351	Fire mode frequency	Fire Mode Freq	0.00~60.00(Hz)	60.00	X/A	O	X	p.117	
82 ²²	0h1352	Fire mode direction	Fire Mode Dir	0	Forward	0: Forward	X/A	O	X	p.117
				1	Reverse					
83 ²²		Fire Mode Count	Fire Mode Cnt	Can not be modified					p.117	

²¹ Displayed when Ad.74 is set to 1 (Yes).

²² Displayed when Ad.80 is set to 1 (Yes).

8.5 Control Function group (PAR→Cn)

In the following table, the data shaded in grey will be displayed when a related code has been selected.

SL: Sensorless vector control (dr.09)

***O/X:** Write-enabled during operation, **7/L/A:** Keypad/LCD keypad/Common

Code	Comm. Address	Name	LCD Display	Setting Range		Initial Value	Property*	V/F	SL	Ref.
00	-	Jump Code	Jump Code	1-99		4	O/A	O	O	p.48
04	0h1404	Carrier frequency	Carrier Freq	Heavy Duty	V/F: 1.0-15.0(kHz) ²³ SL: 2.0-15.0(kHz)	3.0	O/A	O	O	p.164
				Normal Duty	V/F: 1.0-5.0(kHz) ²⁴ SL: 2.0-5.0(kHz)	2.0				p.164
05	0h1405	Switching mode	PWM Mode	0	Normal PWM	0:Normal PWM	X/A	O	O	p.164
				1	Low leakage PWM					
09	0h1409	Initial excitation time	PreExTime	0.00-60.00(s)		1.00	X/A	X	O	p.150
10	0h140A	Initial excitation amount	Flux Force	100.0-300.0(%)		100.0	X/A	X	O	p.150
11	0h140B	Continued operation duration	Hold Time	0.00-60.00(s)		0.00	X/A	X	O	p.150
20	0h1414	Sensorless 2 nd gain display setting	SL2 G View Sel	0	No	0:No	O/A	X	O	p.150
				1	Yes					

²³ In case of 0.4~4.0kW, the setting range is 2.0~15.0(kHz).

²⁴ In case of 0.4~4.0kW, the setting range is 2.0~5.0(kHz).

Code	Comm. Address	Name	LCD Display	Setting Range	Initial Value	Property*	V/F	SL	Ref.
21	0h1415	Sensorless speed controller proportional gain1	ASR-SL P Gain1	0-5000(%)	Dependent on motor setting	O/A	X	O	p.150
22	0h1416	Sensorless speed controller integral gain1	ASR-SL I Gain1	10-9999(ms)		O/A	X	O	p.150
23 ²⁵	0h1417	Sensorless speed controller proportional gain2	ASR-SL P Gain2	1.0-1000.0(%)	Dependent on motor setting	O/A	X	O	p.150
24 ²⁵	0h1418	Sensorless speed controller integral gain2	ASR-SL I Gain2	1.0-1000.0(%)		O/A	X	O	p.150
25 ²⁵	0h1419	Sensorless speed controller integral gain 0	ASR-SL I Gain0	1.0~999.9(ms)		O/A	X	O	-
26 ²⁵	0h141A	Flux estimator proportional gain	Flux P Gain	10-200(%)		O/A	X	O	p.150
27 ²⁵	0h141B	Flux estimator integral gain	Flux I Gain	10-200(%)		O/A	X	O	p.150
28 ²⁵	0h141C	Speed estimator proportional gain	S-Est P Gain1	0-32767		O/A	X	O	p.150
29 ²⁵	0h141D	Speed estimator integral gain1	S-Est I Gain1	100-1000		O/A	X	O	p.150
30 ²⁵	0h141E	Speed estimator integral gain2	S-Est I Gain2	100-10000		O/A	X	O	p.150
31 ²⁵	0h141F	Sensorless current controller proportional gain	ACR SL P Gain	10-1000		O/A	X	O	p.150
32 ²⁵	0h1420	Sensorless current controller integral gain	ACR SL I Gain	10 -1000		O/A	X	O	p.150
48	-	Current controller P gain	ACR P Gain	0-10000	1200	O/A	X	O	-
49	-	Current controller I gain	ACR I Gain	0-10000	120	O/A	X	O	-
52	0h1434	Torque controller output filter	Torque Out LPF	0-2000(ms)	0	X/A	X	O	p.150
53	0h1435	Torque limit setting options	Torque Lmt Src	0	0: Keypad	X/A	X	O	p.150
				1					

²⁵ Displayed when dr.09 is set to 4 (IM Sensorless) and Cn.20 is set to 1 (YES).

Table of Functions

Code	Comm. Address	Name	LCD Display	Setting Range	Initial Value	Property*	V/F	SL	Ref.
				2 V1 4 V2 5 I2 6 Int 485 8 FieldBus 12 Pulse	-1				
54 ²⁶	0h1436	Positive-direction reverse torque limit	FWD +Trq Lmt	0.0-200.0(%)	180	O/A	X	O	p.150
55 ²⁶	0h1437	Positive-direction regeneration torque limit	FWD -Trq Lmt	0.0-200.0(%)	180	O/A	X	O	p.150
56 ²⁶	0h1438	Negative-direction reverse torque limit	REV +Trq Lmt	0.0-200.0(%)	180	O/A	X	O	p.150
57 ²⁶	0h1439	Negative-direction regeneration torque limit	REV -Trq Lmt	0.0-200.0(%)	180	O/A	X	O	p.150
62 ²⁶	0h143E	Speed limit Setting	Speed Lmt Src	0 Keypad-1 1 Keypad-2 2 V1 4 V2 5 I2 6 Int 485 7 FieldBus	0: Keypad -1	X/A	X	O	-
63 ²⁶	0h143F	Positive-direction speed limit	FWD Speed Lmt	0.00~ Maximum frequency (Hz)	60.00	O/A	X	O	-
64 ²⁶	0h1440	Negative-direction speed limit	REV Speed Lmt	0.00~ Maximum frequency (Hz)	60.00	O/A	X	O	-
65 ²⁶	0h1441	Speed limit operation gain	Speed Lmt Gain	100~5000[%]	500	O/A	X	O	-
70	0h 1446	Speed search mode selection	SS Mode	0 Flying Start-1 ²⁷ 1 Flying	0: Flying Start-1	X/A	O	O	p.159

²⁶ Displayed when dr.09 is set to 4 (IM Sensorless). This will change the initial value of the parameter at Ad.74 (Torque limit) to 150%.

²⁷ Will not be displayed if dr.09 is set to 4 (IM Sensorless).

Code	Comm. Address	Name	LCD Display	Setting Range	Initial Value	Property*	V/F	SL	Ref.
71	0h1447	Speed search operation selection	Speed Search	Start-2	0000 ²⁸	X/A	O	O	p.159
				bit 0000- 1111					
				00 Selection of speed search on acceleration					
				01 When starting on initialization after fault trip					
				10 When restarting after instantaneous power interruption					
00 When starting with power on									
72 ²⁹	0h1448	Speed search reference current	SS Sup-Current	80-200(%)	150	O/A	O	O	p.159
73 ³⁰	0h1449	Speed search proportional gain	SS P-Gain	0-9999	Flying Start-1 : 100 Flying Start-2 : 600 ³¹	O/A	O	O	p.159
74 ³⁰	0h144A	Speed search integral gain	SS I-Gain	0-9999	Flying Start-1 : 200	O/A	O	O	p.159

²⁸ The initial value 0000 will be displayed on the keypad as .

²⁹ Displayed when any of the Cn.71 code bits are set to 1 and Cn70 is set to 0 (Flying Start-1).

³⁰ Displayed when any of the Cn.71 code bits are set to 1.

³¹ The initial value is 1200 when the motor-rated capacity is less than 7.5 kW

Table of Functions

Code	Comm. Address	Name	LCD Display	Setting Range	Initial Value	Property*	V/F	SL	Ref.
					Flying Start-2 : 1000				
75 ³⁰	0h144B	Output blocking time before speed search	SS Block Time	0.0-60.0(s)	1.0	X/A	O	O	p.159
76 ³⁰	0h144C	Speed search Estimator gain	Spd Est Gain	50-150(%)	100	O/A	O	O	-
77	0h144D	Energy buffering selection	KEB Select	0 No 1 Yes	0:No	X/A	O	O	p.154
78 ³²	0h144E	Energy buffering start level	KEB Start Lev	110.0-140.0(%)	125.0	X/A	O	O	p.154
79 ³²	0h144F	Energy buffering stop level	KEB Stop Lev	125.0-145.0(%)	130.0	X/A	O	O	p.154
80 ³²	0h1450	Energy buffering gain	KEB Gain	1-20000	1000	O/A	O	O	p.154
85 ³³	0h1455	Flux estimator proportional gain1	Flux P Gain1	100-700	370	O/A	X	O	p.150
86 ³³	0h1456	Flux estimator proportional gain2	Flux P Gain2	0-100	0	O/A	X	O	p.150
87 ³³	0h1457	Flux estimator proportional gain3	Flux P Gain3	0-500	100	O/A	X	O	p.150
88 ³³	0h1458	Flux estimator integral gain1	Flux I Gain1	0-200	50	O/A	X	O	p.150
89 ³³	0h1459	Flux estimator integral gain2	Flux I Gain2	0-200	50	O/A	X	O	p.150
90 ³³	0h145A	Flux estimator integral gain3	Flux I Gain3	0-200	50	O/A	X	O	p.150
91 ³³	0h145B	Sensorless voltage compensation1	SL Volt Comp1	0-60	Dependent on motor setting	O/A	X	O	p.150
92 ³³	0h145C	Sensorless voltage compensation2	SL Volt Comp2	0-60		O/A	X	O	p.150
93 ³³	0h145D	Sensorless voltage compensation3	SL Volt Comp3	0-60		O/A	X	O	p.150

³² Displayed when Cn.77 is set to 1 (Yes).

³³ Displayed when Cn.20 is set to 1 (Yes).

Code	Comm. Address	Name	LCD Display	Setting Range	Initial Value	Property*	V/F	SL	Ref.
94 ³³	0h145E	Sensorless field weakening start frequency	SL FW Freq	80.0-110.0(%)	100.0	X/A	X	O	p.147
95 ³³	0h145F	Sensorless gain switching frequency	SL Fc Freq	0.00-8.00(Hz)	2.00	X/A	X	O	p.147

8.6 Input Terminal Block Function group (PAR→In)

In the following table, the data shaded in grey will be displayed when a related code has been selected.

SL: Sensorless vector control (dr.09)

***O/X:** Write-enabled during operation, **7/L/A:** Keypad/LCD keypad/Common

Code	Comm. Address	Name	LCD Display	Setting Range	Initial Value	Property*	V/F	SL	Ref.	
00	-	Jump Code	Jump Code	1-99	65	O/A	O	O	p.48	
01	0h1501	Frequency for maximum analog input	Freq at 100%	Start frequency- Maximum frequency(Hz)	Maximum frequency	O/A	O	O	p.67	
02	0h1502	Torque at maximum analog input	Torque at100%	0.0-200.0(%)	100.0	O/A	X	X	-	
05	0h1505	V1 input voltage display	V1 Monitor(V)	-12.00-12.00(V)	0.00	-/A	O	O	p.67	
06	0h1506	V1 input polarity selection	V1 Polarity	0	Unipolar	0: Unipolar	X/A	O	O	p.67
				1	Bipolar					
07	0h1507	Time constant of V1 input filter	V1 Filter	0-10000(ms)	10	O/A	O	O	p.67	
08	0h1508	V1 Minimum input voltage	V1 Volt x1	0.00-10.00(V)	0.00	O/A	O	O	p.67	
09	0h1509	V1 output at Minimum voltage (%)	V1 Perc y1	0.00-100.00(%)	0.00	O/A	O	O	p.67	
10	0h150A	V1 Maximum input voltage	V1 Volt x2	0.00-12.00(V)	10.00	O/A	O	O	p.67	

Function Table

Table of Functions

Code	Comm. Address	Name	LCD Display	Setting Range	Initial Value	Property*	V/F	SL	Ref.	
11	0h150B	V1 output at Maximum voltage (%)	V1 Perc y2	0.00-100.00(%)	100.00	O/A	O	O	p.67	
12 ³⁴	0h150C	V1 Minimum input voltage	V1 -Volt x1'	-10.00- 0.00(V)	0.00	O/A	O	O	p.70	
13 ³⁴	0h150D	V1 output at Minimum voltage (%)	V1 -Perc y1'	-100.00-0.00(%)	0.00	O/A	O	O	p.70	
14 ³⁴	0h150E	V1 Maximum input voltage	V1 -Volt x2'	-12.00- 0.00(V)	-10.00	O/A	O	O	p.70	
15 ³⁴	0h150F	V1 output at Maximum voltage (%)	V1 -Perc y2'	-100.00-0.00(%)	-100.00	O/A	O	O	p.70	
16	0h1510	V1 rotation direction change	V1 Inverting	0	No	0: No	O/A	O	O	p.67
				1	Yes					
17	0h1511	V1 quantization level	V1 Quantizing	0.00 ³⁵ , 0.04-10.00(%)	0.04	X/A	O	O	p.67	
35 ³⁶	0h1523	V2 input voltage display	V2 Monitor(V)	0.00-12.00(V)	0.00	-/A	O	O	p.74	
37 ³⁶	0h1525	V2 input filter time constant	V2 Filter	0-10000(ms)	10	O/A	O	O	p.74	
38 ³⁶	0h1526	V2 Minimum input voltage	V2 Volt x1	0.00-10.00(V)	0.00	O/A	X	X	p.74	
39 ³⁶	0h1527	V2 output at Minimum voltage (%)	V2 Perc y1	0.00-100.00(%)	0.00	O/A	O	O	p.74	
40 ³⁶	0h1528	V2 Maximum input voltage	V2 Volt x2	0.00-10.00(V)	10	O/A	X	X	p.74	
41 ³⁶	0h1529	V2 output at Maximum voltage (%)	V2 Perc y2	0.00-100.00(%)	100.00	O/A	O	O	p.74	
46 ³⁶	0h152E	V2 rotation direction change	V2 Inverting	0	No	0:No	O/A	O	O	p.74
				1	Yes					
47 ³⁶	0h152F	V2	V2 Quantizing	0.00 ³⁵ , 0.04-	0.04	O/A	O	O	p.74	

³⁴ Displayed when In.06 is set to 1 (Bipolar).

³⁵ Quantizing is not used when set to 0.

³⁶ Displayed when V is selected on the analog current/voltage input circuit selection switch (SW2).

Code	Comm. Address	Name	LCD Display	Setting Range	Initial Value	Property*	V/F	SL	Ref.	
		quantization level		10.00(%)						
50 ³⁷	0h1532	I2 input current display	I2 Monitor (mA)	0-24(mA)	0.00	-/A	O	O	p.72	
52 ³⁷	0h1534	I2 input filter time constant	I2 Filter	0-10000(ms)	10	O/A	O	O	p.72	
53 ³⁷	0h1535	I2 minimum input current	I2 Curr x1	0.00-20.00(mA)	4.00	O/A	O	O	p.72	
54 ³⁷	0h1536	I2 output at Minimum current (%)	I2 Perc y1	0.00-100.00(%)	0.00	O/A	O	O	p.72	
55 ³⁷	0h1537	I2 maximum input current	I2 Curr x2	0.00-24.00(mA)	20.00	O/A	O	O	p.72	
56 ³⁷	0h1538	I2 output at Maximum current (%)	I2 Perc y2	0.00-100.00(%)	100.00	O/A	O	O	p.72	
61 ³⁷	0h153D	Changing rotation direction of I2	I2 Inverting	0	No	0:No	O/A	O	O	p.72
				1	Yes					
62 ³⁷	0h153E	I2 quantization level	I2 Quantizing	0.00 ³⁵ ,0.04-10.00(%)	0.04	O/A	O	O	p.72	
65	0h1541	P1 terminal function setting	P1 Define	0	None	1:Fx	X/A	O	O	p.79
				1	Fx					
66	0h1542	P2 terminal function setting	P2 Define	2	Rx	2:Rx	X/A	O	O	p.79
67	0h1543	P3 terminal function setting	P3 Define	3	RST	5:BX	X/A	O	O	p.214
68	0h1544	P4 terminal function setting	P4 Define	4	External Trip	3:RST	X/A	O	O	p.204
69	0h1545	P5 terminal function setting	P5 Define	5	BX	7:Sp-L	X/A	O	O	p.214
70	0h1546	P6 terminal function setting	P6 Define	6	JOG	8:Sp-M	X/A	O	O	p.126

³⁷ Displayed when I is selected on the analog current/voltage input circuit selection switch (SW2).

Table of Functions

Code	Comm. Address	Name	LCD Display	Setting Range		Initial Value	Property*	V/F	SL	Ref.
71	0h1547	P7 terminal function setting	P7 Define	7	Speed-L	9:Sp-H	X/A	O	O	p.77
				8	Speed-M					p.77
				9	Speed-H					p.77
				11	XCEL-L					p.88
				12	XCEL-M					p.88
				13	RUN Enable					p.131
				14	3-Wire					p.130
				15	2nd Source					p.106
				16	Exchange					p.167
				17	Up					p.129
				18	Down					p.129
				20	U/D Clear					p.129
				21	Analog Hold					p.76
				22	I-Term Clear					p.136
				23	PID Openloop					p.136
				24	P Gain2					p.136
				25	XCEL Stop					p.94
				26	2nd Motor					p.166
				34	Pre Excite					-
				38	Timer In					p.177
				40	dis Aux Ref					p.122
				46	FWD JOG					p.128
				47	REV JOG					p.128
				49	XCEL-H					p.88
				50	User Seq					p.111
				51	Fire Mode					p.117
				54	TI ³⁸					p.74
85	0h1555	Multi-function input terminal On filter	DI On Delay	0-10000(ms)		10	O/A	O	O	p.107
86	0h1556	Multi-function input terminal Off filter	DI Off Delay	0-10000(ms)		3	O/A	O	O	p.107
87	0h1557	Multi-function input contact selection	DI INC/NO Sel	P7 – P1		0 0000 ³⁹	X/A	O	O	p.107
				0	A contact (NO)					
				1	B contact (NC)					

³⁸ Displayed when P5 is selected on Px terminal function.

³⁹ The initial value 0000 will be displayed on the keypad as .

Code	Comm. Address	Name	LCD Display	Setting Range	Initial Value	Property*	V/F	SL	Ref.	
89	0h1559	Multi-step command delay time	InCheck Time	1-5000(ms)	1	X/A	O	O	p.77	
90	0h155A	Multi-function input terminal status	DI Status	P7 – P1	0 0000 ³⁹	-/A	O	O	p.107	
				0						release(Off)
				1						Connection (On)
91	0h155B	Pulse input amount display	Pulse Monitor (kHz)	0.00-50.00(kHz)	0.00	-/A	O	O	p.74	
92	0h155C	TI input filter time constant	TI Filter	0-9999(ms)	10	O/A	O	O	p.74	
93	0h155D	TI Minimum input pulse	TI Pls x1	0.00-32.00(kHz)	0.00	O/A	O	O	p.74	
94	0h153E	TI output at Minimum pulse (%)	TI Perc y1	0.00-100.00(%)	0.00	O/A	O	O	p.74	
95	0h155F	TI Maximum input pulse	TI Pls x2	0.00-32.00(kHz)	32.00	O/A	O	O	p.74	
96	0h1560	TI Output at Maximum pulse (%)	TI Perc y2	0-100(%)	100.00	O/A	O	O	p.74	
97	0h1561	TI rotation direction change	TI Inverting	0	No	0:No	O/A	O	O	p.74
				1	Yes					
98	0h1562	TI quantization level	TI Quantizing	0.00 ³⁵ , 0.04-10.00(%)	0.04	O/A	O	O	p.74	
99	0h1563	SW1(NPN/PNP) SW2(V1/V2[I2]) status	IO SW State	Bit	00~11	00	-/A	O	O	-
				00	V2, NPN					
				01	V2, PNP					
				10	I2, NPN					
				11	I2, PNP					

8.7 Output Terminal Block Function group (PAR→OU)

In the following table, the data shaded in grey will be displayed when a related code has been selected.

SL: Sensorless vector control (dr.09)

***O/X:** Write-enabled during operation, **7/L/A:** Keypad/LCD keypad/Common

Code	Comm. Address	Name	LCD Display	Setting Range	Initial Value	Property*	V/F	SL	Ref.	
00	-	Jump Code	JumpCode	1-99	30	O/A	O	O	p.48	
01	0h1601	Analog output 1 item	AO1 Mode	0	Frequency	0:Frequency	O/A	O	O	p.181
				1	Output Current					
				2	Output Voltage					
				3	DCLink Voltage					
				4	Torque					
				5	Output Power					
				6	Idse					
				7	Iqse					
				8	Target Freq					
				9	Ramp Freq					
				10	Speed Fdb					
				12	PID Ref Value					
				13	PID Fdb Value					
				14	PID Output					
				15	Constant					
02	0h1602	Analog output 1 gain	AO1 Gain	-1000.0-1000.0(%)	100.0	O/A	O	O	p.181	
03	0h1603	Analog output 1 bias	AO1 Bias	-100.0-100.0(%)	0.0	O/A	O	O	p.181	
04	0h1604	Analog output 1 filter	AO1 Filter	0-10000(ms)	5	O/A	O	O	p.181	
05	0h1606	Analog constant output 1	AO1 Const %	0.0-100.0(%)	0.0	O/A	O	O	p.181	
06	0h1606	Analog output 1 monitor	AO1 Monitor	0.0-1000.0(%)	0.0	-/A	O	O	p.181	
30	0h161E	Fault output item	Trip Out Mode	bit	000-111	010 ⁴⁰	O/A	O	O	p.191
				1	Low voltage					
				2	Any faults other					

⁴⁰ The initial value 0010 will be displayed on the keypad as .

Code	Comm. Address	Name	LCD Display	Setting Range	Initial Value	Property*	V/F	SL	Ref.	
				than low voltage						
				3 Automatic restart final failure						
31	0h161F	Multi-function relay 1 item	Relay 1	0	None	29:Trip	O/A	O	O	p.187
				1	FDT-1					
				2	FDT-2					
				3	FDT-3					
				4	FDT-4					
				5	Over Load					
				6	IOL					
				7	Under Load					
				8	Fan Warning					
				9	Stall					
				10	Over Voltage					
				11	Low Voltage					
				12	Over Heat					
				13	Lost Command					
				14	Run					
				15	Stop					
				16	Steady					
				17	Inverter Line					
				18	Comm Line					
				19	Speed Search					
				22	Ready					
				28	Timer Out					
				29	Trip					
				31	DB Warn%ED					
				34	On/Off Control					
				35	BR Control					
				36	CAP.Warning					
				37	FAN Exchange					
38	Fire Mode									
33	0h1621	Multi-function output 1 item	Q1 Define	0	None	14:Run	O/A	O	O	p.187
				1	FDT-1					
				2	FDT-2					
				3	FDT-3					
				4	FDT-4					
				5	Over Load					
				6	IOL					

Table of Functions

Code	Comm. Address	Name	LCD Display	Setting Range	Initial Value	Property*	V/F	SL	Ref.	
				7 Under Load						
				8 Fan Warning						
				9 Stall						
				10 Over Voltage						
				11 Low Voltage						
				12 Over Heat						
				13 Lost Command						
				14 Run						
				15 Stop						
				16 Steady						
				17 Inverter Line						
				18 Comm Line						
				19 Speed Search						
				22 Ready						
				28 Timer Out						
				29 Trip						
				31 DB Warn%ED						
				34 On/Off Control						
				35 BR Control						
				36 CAP.Warning						
				37 FAN Exchange						
				38 Fire Mode						
				39 TO						
41	0h1629	Multi-function output monitor	DO Status	-	00	-/A	-	-	p.187	
50	0h1632	Multi-function output On delay	DO On Delay	0.00-100.00(s)	0.00	O/A	O	O	p.192	
51	0h1633	Multi-function output Off delay	DO Off Delay	0.00-100.00(s)	0.00	O/A	O	O	p.192	
52	0h1634	Multi-function output contact selection	DO NC/NO Sel	Q1, Relay1		00 ⁴¹	X/A	O	O	p.192
				0	A contact (NO)					
				1	B contact (NC)					

⁴¹ The initial value 0000 will be displayed on the keypad as .

Code	Comm. Address	Name	LCD Display	Setting Range	Initial Value	Property*	V/F	SL	Ref.	
53	0h1635	Fault output On delay	TripOut OnDly	0.00-100.00(s)	0.00	O/A	O	O	p.191	
54	0h1636	Fault output Off delay	TripOut OffDly	0.00-100.00(s)	0.00	O/A	O	O	p.191	
55	h1637	Timer On delay	TimerOn Delay	0.00-100.00(s)	0.00	O/A	O	O	p.177	
56	0h1638	Timer Off delay	TimerOff Delay	0.00-100.00(s)	0.00	O/A	O	O	p.177	
57	0h1639	Detected frequency	FDT Frequency	0.00-Maximum frequency(Hz)	30.00	O/A	O	O	p.187	
58	0h163A	Detected frequency band	FDT Band	0.00-Maximum frequency(Hz)	10.00	O/A	O	O	p.187	
61	0h163D	Pulse output gain	TO Mode	0	Frequency	0: Frequency	O/A	O	O	p.184
				1	Output Current					
				2	Output Voltage					
				3	DCLink Voltage					
				4	Torque					
				5	Output Power					
				6	Idse					
				7	Iqse					
				8	Target Freq					
				9	Ramp Freq					
				10	Speed Fdb					
				12	PID Ref Value					
				13	PID Fdb Value					
				14	PID Output					
				15	Constant					
62	0h163E	Pulse output gain	TO Gain	-1000.0-1000.0(%)	100.0	O/A	O	O	p.184	
63	0h163F	Pulse output bias	TO Bias	-100.0-100.0(%)	0.0	O/A	O	O	p.184	
64	0h1640	Pulse output filter	TO Filter	0-10000(ms)	5	O/A	O	O	p.184	
65	0h1641	Pulse output constant output 2	TO Const %	0.0-100.0(%)	0.0	O/A	O	O	p.184	
66	0h1642	Pulse output monitor	TO Monitor	0.0-1000.0(%)	0.0	-/A	O	O	p.184	

8.8 Communication Function group (PAR→CM)

In the following table, the data shaded in grey will be displayed when a related code has been selected.

SL: Sensorless vector control (dr.09)

***O/X:** Write-enabled during operation, **7/L/A:** Keypad/LCD keypad/Common

Code	Comm. Address	Name	LCD Display	Setting Range	Initial Value	Property*	V/F	SL	Ref.
00	-	Jump Code	Jump Code	1-99	20	O/A	O	O	<u>p.48</u>
01	0h1701	Built-in communication inverter ID	Int485 St ID	1-250	1	O/A	O	O	<u>p.220</u>
02 ⁴²	0h1702	Built-in communication protocol	Int485 Proto	0 ModBus RTU 2 LS Inv 485	0: ModBus RTU	O/A	O	O	<u>p.220</u>
03 ⁴²	0h1703	Built-in communication speed	Int485 BaudR	0 1200 bps 1 2400 bps 2 4800 bps 3 9600 bps 4 19200 bps 5 38400 bps 6 56 Kbps 7 115 Kbps ⁴³	3: 9600 bps	O/A	O	O	<u>p.220</u>
04 ⁴²	0h1704	Built-in communication frame setting	Int485 Mode	0 D8/PN/S1 1 D8/PN/S2 2 D8/PE/S1 3 D8/PO/S1	0: D8/PN/S1	O/A	O	O	<u>p.220</u>
05 ⁴²	0h1705	Transmission delay after reception	Resp Delay	0-1000(ms)	5ms	O/A	O	O	<u>p.220</u>
06 ⁴⁴	0h1706	Communication option S/W version	FBus S/W Ver	-	0.00	O/A	O	O	-
07 ⁴⁴	0h1707	Communication option inverter ID	FBus ID	0-255	1	O/A	O	O	-

⁴² Will not be displayed when P2P and MultiKPD is set.

⁴³ 115,200bps

⁴⁴ Displayed only when a communication option card is installed.

Code	Comm. Address	Name	LCD Display	Setting Range	Initial Value	Property*	V/F	SL	Ref.
08 ⁴⁴	0h1708	FIELD BUS communication speed	FBUS BaudRate	-	12Mbps	-/A	O	O	-
09 ⁴⁴	0h1709	Communication option LED status	FieldBus LED	-	-	O/A	O	O	-
30	0h171E	Number of output parameters	ParaStatus Num	0-8	3	O/A	O	O	
31 ⁴⁵	0h171F	Output Communication address1	Para Stauts-1	0000-FFFF Hex	000A	O/A	O	O	<u>p.225</u>
32 ⁴⁵	0h1720	Output Communication address2	Para Stauts-2	0000-FFFF Hex	000E	O/A	O	O	<u>p.225</u>
33 ⁴⁵	0h1721	Output Communication address3	Para Stauts-3	0000-FFFF Hex	000F	O/A	O	O	<u>p.225</u>
34 ⁴⁵	0h1722	Output Communication address4	Para Stauts-4	0000-FFFF Hex	0000	O/A	O	O	<u>p.225</u>
35 ⁴⁵	0h1723	Output Communication address5	Para Stauts-5	0000-FFFF Hex	0000	O/A	O	O	<u>p.225</u>
36 ⁴⁵	0h1724	Output Communication address6	Para Stauts-6	0000-FFFF Hex	0000	O/A	O	O	<u>p.225</u>
37 ⁴⁵	0h1725	Output Communication address7	Para Stauts-7	0000-FFFF Hex	0000	O/A	O	O	<u>p.225</u>
38 ⁴⁵	0h1726	Output Communication address8	Para Stauts-8	0000-FFFF Hex	0000	O/A	O	O	<u>p.225</u>
50	0h1732	Number of input parameters	Para Ctrl Num	0-8	2	O/A	O	O	
51 ⁴⁶	0h1733	Input Communication address1	Para Control-1	0000-FFFF Hex	0005	X/A	O	O	<u>p.225</u>

Function Table

⁴⁵ Only the range of addresses set at COM-30 is displayed.

⁴⁶ Only the range of addresses set at COM-50 is displayed.

Table of Functions

Code	Comm. Address	Name	LCD Display	Setting Range		Initial Value	Property*	V/F	SL	Ref.
52 ⁴⁶	0h1734	Input Communication address2	Para Control-2	0000-FFFF Hex		0006	X/A	O	O	p.225
53 ⁴⁶	0h1735	Input Communication address3	Para Control-3	0000-FFFF Hex		0000	X/A	O	O	p.225
54 ⁴⁶	0h1736	Input Communication address4	Para Control-4	0000-FFFF Hex		0000	X/A	O	O	p.225
55 ⁴⁶	0h1737	Input Communication address5	Para Control-5	0000-FFFF Hex		0000	X/A	O	O	p.225
56 ⁴⁶	0h1738	Input Communication address6	Para Control-6	0000-FFFF Hex		0000	X/A	O	O	p.225
57 ⁴⁶	0h1739	Input Communication address7	Para Control-7	0000-FFFF Hex		0000	X/A	O	O	p.225
58 ⁴⁶	0h173A	Input Communication address8	Para Control-8	0000-FFFF Hex		0000	X/A	O	O	p.225
68	0h1744	Field bus data swap	FBus Swap Sel	0	No	0	X/A	O	O	p.225
				1	Yes					
70	0h1746	Communication multi-function input 1	Virtual DI 1	0	None	0:None	O/A	O	O	p.244
71	0h1747	Communication multi-function input 2	Virtual DI 2	1	Fx	0:None	O/A	O	O	p.244
72	0h1748	Communication multi-function input 3	Virtual DI 3	2	Rx	0:None	O/A	O	O	p.244
73	0h1749	Communication multi-function input 4	Virtual DI 4	3	RST	0:None	O/A	O	O	p.244
74	0h174A	Communication multi-function input 5	Virtual DI 5	4	External Trip	0:None	O/A	O	O	p.244

Code	Comm. Address	Name	LCD Display	Setting Range		Initial Value	Property*	V/F	SL	Ref.
75	0h174B	Communication multi-function input 6	Virtual DI 6	5	BX	0:None	O/A	O	O	<u>p.244</u>
76	0h174C	Communication multi-function input 7	Virtual DI 7	6	JOG	0:None	O/A	O	O	<u>p.244</u>
77	0h174D	Communication multi-function input 8	Virtual DI 8	7	Speed-L	0:None	O/A	O	O	<u>p.244</u>
				8	Speed-M					
				9	Speed-H					
				11	XCEL-L					
				12	XCEL-M					
				13	RUN Enable					
				14	3-Wire					
				15	2nd Source					
				16	Exchange					
				17	Up					
				18	Down					
				20	U/D Clear					
				21	Analog Hold					
				22	I-Term Clear					
				23	PID Openloop					
				24	P Gain2					
				25	XCEL Stop					
26	2nd Motor									
34	Pre Excite									
38	Timer In									
40	dis Aux Ref									
46	FWD JOG									
47	REV JOG									
49	XCEL-H									
86	0h1756	Communication multi-function input monitoring	Virt DI Status	-		0	X/A	O	O	<u>p.223</u>
90	0h175A	Selection of data frame communication monitor	Comm Mon Sel	0	Int485	0	O/A	O	O	-
				1	KeyPad					
91	0h175B	Data frame Rev count	Rcv Frame Num	0~65535		0	O/A	O	O	-

Table of Functions

Code	Comm. Address	Name	LCD Display	Setting Range	Initial Value	Property*	V/F	SL	Ref.
92	0h175C	Data frame Err count	Err Frame Num	0~65535	0	O/A	O	O	-
93	0h175D	NAK frame count	NAK Frame Num	0~65535	0	O/A	O	O	-
94 ⁴⁷	-	Communication data upload	Comm Update	0 No 1 Yes	0:No	-/A	O	O	-
95	0h1760	P2P communication selection	Int 485 Func	0 Disable All	0: Disable All	X/A	O	O	<u>p.108</u>
				1 P2P Master					
				2 P2P Slave					
				3 KPD-Ready					
96 ⁴⁸	-	DO setting selection	P2P OUT Sel	Bit 000~111	0:No	O/A	O	O	<u>p.108</u>
				001 Analog output					
				010 Multi-function relay					
				100 Multi-function output					

⁴⁷ Displayed only when a communication option card is installed.

⁴⁸ Displayed when AP01 is set to 2 (Proc PID).

8.9 Application Function group (PAR→AP)

In the following table, the data shaded in grey will be displayed when a related code has been selected.

SL: Sensorless vector control (dr.09)

***O/X:** Write-enabled during operation, **7/L/A:** Keypad/LCD keypad/Common

Code	Comm. Address	Name	LCD Display	Setting Range	Initial Value	Property *	V/F	SL	Ref.	
00	-	Jump Code	Jump Code	1-99	20	O/A	O	O	p.48	
01	0h1801	Application function selection	App Mode	0	None	0: None	X/A	O	O	p.136
				1	-					
				2	Proc PID					
02	-	Enable user sequence	User Seq En	0	No	0:No	X/A	O	O	p.111
				1	Yes					
16 ⁴⁹	0h1810	PID output monitor	PID Output	(%)	0.00	-/A	O	O	p.136	
17 ⁴⁹	0h1811	PID reference monitor	PID Ref Value	(%)	50.00	-/A	O	O	p.136	
18 ⁴⁹	0h1812	PID feedback monitor	PID Fdb Value	(%)	0.00	-/A	O	O	p.136	
19 ⁴⁹	0h1813	PID reference setting	PID Ref Set	-100.00-100.00(%)	50.00	O/A	O	O	p.136	
20 ⁴⁹	0h1814	PID reference source	PID Ref Source	0	Keypad	0: Keypad	X/A	O	O	p.136
				1	V1					
				3	V2					
				4	I2					
				5	Int 485					
				7	FieldBus					
				11	Pulse					
21 ⁴⁹	0h1815	PID feedback source	PID F/B Source	0	V1	0:V1	X/A	O	O	p.136
				2	V2					
				3	I2					
				4	Int 485					
				6	FieldBus					
				10	Pulse					
22 ⁴⁹	0h1816	PID controller proportional gain	PID P-Gain	0.0-1000.0(%)	50.0	O/A	O	O	p.136	
23 ⁴⁹	0h1817	PID controller integral time	PID I-Time	0.0-200.0(s)	10.0	O/A	O	O	p.136	

⁴⁹ Displayed when AP01 is set to 2 (Proc PID).

Table of Functions

Code	Comm. Address	Name	LCD Display	Setting Range	Initial Value	Property *	V/F	SL	Ref.	
24 ⁴⁹	0h1818	PID controller differentiation time	PID D-Time	0-1000(ms)	0	O/A	O	O	p.136	
25 ⁴⁹	0h1819	PID controller feed-forward compensation gain	PID F-Gain	0.0-1000.0(%)	0.0	O/A	O	O	p.136	
26 ⁴⁹	0h181A	Proportional gain scale	P Gain Scale	0.0-100.0(%)	100.0	X/A	O	O	p.136	
27 ⁴⁹	0h181B	PID output filter	PID Out LPF	0-10000(ms)	0	O/A	O	O	p.136	
28 ⁴⁹	0h181C	PID Mode	PID Mode	0	Process PID	0	X/A	O	O	-
				1	Normal PID					
29 ⁴⁹	0h181D	PID upper limit frequency	PID Limit Hi	PID lower limit frequency-300.00(Hz)	60.00	O/A	O	O	p.136	
30 ⁴⁹	0h181E	PID lower limit frequency	PID Limit Lo	-300.00 -PID upper limit frequency(Hz)	-60.00	O/A	O	O	p.136	
31 ⁴⁹	0h181F	PID output inverse	PID Out Inv	0	No	0:No	X/A	O	O	p.136
				1	Yes					
32 ⁴⁹	0h1820	PID output scale	PID Out Scale	0.1-1000.0(%)	100.0	X/A	O	O	p.136	
34 ⁴⁹	0h1822	PID controller motion frequency	Pre-PID Freq	0.00- Maximum frequency(Hz)	0.00	X/A	O	O	p.136	
35 ⁴⁹	0h1823	PID controller motion level	Pre-PID Exit	0.0-100.0(%)	0.0	X/A	O	O	p.136	
36 ⁴⁹	0h1824	PID controller motion delay time	Pre-PID Delay	0-9999(s)	600	O/A	O	O	p.136	
37 ⁴⁹	0h1825	PID sleep mode delay time	PID Sleep DT	0.0-999.9(s)	60.0	O/A	O	O	p.136	
38 ⁴⁹	0h1826	PID sleep mode frequency	PID Sleep Freq	0.00- Maximum frequency(Hz)	0.00	O/A	O	O	p.136	
39 ⁴⁹	0h1827	PID wake-up level	PIDWakeUp Lev	0-100(%)	35	O/A	O	O	p.136	
40 ⁴⁹	0h1828	PID wake-up mode setting	PID WakeUp Mod	0	Below Level	0:Below Level	O/A	O	O	p.136
				1	Above Level					
				2	Beyond Level					

Code	Comm. Address	Name	LCD Display	Setting Range	Initial Value	Property *	V/F	SL	Ref.	
42 ⁴⁹	0h182A	PID controller unit selection	PID Unit Sel	0	%	0:0%	O/A	O	O	p.136
				1	Bar					
				2	mBar					
				3	Pa					
				4	kPa					
				5	Hz					
				6	rpm					
				7	V					
				8	I					
				9	kW					
				10	HP					
				11	°C					
12	°F									
43 ⁴⁹	0h182B	PID unit gain	PID Unit Gain	0.00-300.00(%)	100.00	O/A	O	O	p.136	
44 ⁴⁹	0h182C	PID unit scale	PID Unit Scale	0	x100	2:x 1	O/A	O	O	p.136
				1	x10					
				2	x 1					
				3	x 0.1					
				4	x 0.01					
45 ⁴⁹	0h182D	PID 2nd proportional gain	PID P2-Gain	0.0-1000.0(%)	100.0	X/A	O	O	p.136	

8.10 Protection Function group (PAR→Pr)

In the following table, the data shaded in grey will be displayed when a related code has been selected.

SL: Sensorless vector control (dr.09)

***O/X:** Write-enabled during operation, **7/L/A:** Keypad/LCD keypad/Common

Code	Comm. Address	Name	LCD Display	Setting Range	Initial Value	Property *	V/F	SL	Ref.	
00	-	Jump Code	Jump Code	1-99	40	O/A	O	O	p.48	
04	0h1B04	Load level setting	Load Duty	0	Normal Duty	1:Heavy Duty	X/A	O	O	p.198
				1	Heavy Duty					
05	0h1B05	Input/output open-phase protection	Phase Loss Chk	bi	00-11	00 ⁵⁰	X/A	O	O	p.203
				01	Output open phase					
				10	Input open phase					
06	0h1B06	Input voltage range during open-phase	IPOV Band	1-100(V)	15	X/A	O	O	p.203	
07	0h1B07	Deceleration time at fault trip	Trip Dec Time	0.0-600.0(s)	3.0	O/A	O	O	-	
08	0h1B08	Selection of startup on trip reset	RST Restart	0	No	0:No	O/A	O	O	p.163
				1	Yes					
09	0h1B09	Number of automatic restarts	Retry Number	0-10	0	O/A	O	O	p.163	
10 ⁵¹	0h1B0A	Automatic restart delay time	Retry Delay	0.0-60.0(s)	1.0	O/A	O	O	p.163	

⁵⁰ The initial value 0000 will be displayed on the keypad as .

⁵¹ Displayed when Pr.09 is set higher than 0.

Code	Comm. Address	Name	LCD Display	Setting Range	Initial Value	Property *	V/F	SL	Ref.	
12	0h1B0C	Motion at speed command loss	Lost Cmd Mode	0	None	0:None	O/A	O	O	p.206
				1	Free-Run					
				2	Dec					
				3	Hold Input					
				4	Hold Output					
5	Lost Preset									
13 ⁵²	0h1B0D	Time to decide speed command loss	Lost Cmd Time	0.1-120(s)	1.0	O/A	O	O	p.206	
14 ⁵²	0h1B0E	Operation frequency at speed command loss	Lost Preset F	Start frequency-Maximum frequency(Hz)	0.00	O/A	O	O	p.206	
15 ⁵²	0h1B0F	Analog input loss decision level	AI Lost Level	0	Half x1	0:Half of x1	O/A	O	O	p.206
				1	Below x1					
17	0h1B11	Overload warning selection	OL Warn Select	0	No	0:No	O/A	O	O	p.198
				1	Yes					
18	0h1B12	Overload alarm level	OL Warn Level	30-180(%)	150	O/A	O	O	p.198	
19	0h1B13	Overload warning time	OL Warn Time	0.0-30.0(s)	10.0	O/A	O	O	p.198	
20	0h1B14	Motion at overload fault	OL Trip Select	0	None	1:Free-Run	O/A	O	O	p.198
				1	Free-Run					
				2	Dec					
21	0h1B15	Overload fault level	OL Trip Level	30-200(%)	180	O/A	O	O	p.198	
22	0h1B16	Overload fault time	OL Trip Time	0.0-60.0(s)	60.0	O/A	O	O	p.198	
25	0h1B19	Underload warning selection	UL Warn Sel	0	No	0:No	O/A	O	O	p.209
				1	Yes					
26	0h1B1A	Underload warning time	UL Warn Time	0.0-600.0(s)	10.0	O/A	O	O	p.209	
27	0h1B1B	Underload fault	UL Trip Sel	0	None	0:None	O/A	O	O	p.209

⁵² Displayed when Pr.12 is not set to 0 (NONE).

Table of Functions

Code	Comm. Address	Name	LCD Display	Setting Range		Initial Value	Property *	V/F	SL	Ref.
		selection		1	Free-Run					
				2	Dec					
28	0h1B1C	Underload fault time	UL Trip Time	0.0-600.0(s)		30.0	O/A	O	O	p.209
29	0h1B1D	Underload lower limit level	UL LF Level	10-30(%)		30	O/A	O	O	p.209
30	0h1B1E	Underload upper limit level	UL BF Level	30-100(%)		30	O/A	O	O	p.209
31	0h1B1F	No motor motion at detection	No Motor Trip	0	None	0:None	O/A	O	O	p.216
				1	Free-Run					
32	0h1B20	No motor detection current level	No Motor Level	1-100(%)		5	O/A	O	O	p.216
33	0h1B21	No motor detection delay	No Motor Time	0.1-10.0(s)		3.0	O/A	O	O	p.216
40	0h1B28	Electronic thermal fault selection	ETH Trip Sel	0	None	0:None	O/A	O	O	p.197
				1	Free-Run					
				2	Dec					
41	0h1B29	Motor cooling fan type	Motor Cooling	0	Self-cool	0:Self-cool	O/A	O	O	p.197
				1	Forced-cool					
42	0h1B2A	Electronic thermal 1 minute rating	ETH 1min	120-200(%)		150	O/A	O	O	p.197
43	0h1B2B	Electronic thermal continuous rating	ETH Cont	50-150(%)		120	O/A	O	O	p.197
45	0h1B2D	BX trip mode	BX Mode	0	Free-Run	0	X/A	O	O	-
				1	Dec					
50	0h1B32	Stall prevention motion and flux braking	Stall Prevent	bit	0000-1111	1000	X/A	O	O	p.200
				0001	Accelerating					
				0010	At constant speed					

Code	Comm. Address	Name	LCD Display	Setting Range	Initial Value	Property *	V/F	SL	Ref.
				0100 At deceleration					
				1000 FluxBraking					
51	0h1B33	Stall frequency1	Stall Freq 1	Start frequency-Stall frequency2(Hz)	60.00	O/A	O	O	<u>p.200</u>
52	0h1B34	Stall level1	Stall Level 1	30-250(%)	180	X/A	O	O	<u>p.200</u>
53	0h1B35	Stall frequency2	Stall Freq 2	Stall frequency1-Stall frequency3(Hz)	60.00	O/A	O	O	<u>p.200</u>
54	0h1B36	Stall level2	Stall Level 2	30-250(%)	180	X/A	O	O	<u>p.200</u>
55	0h1B37	Stall frequency3	Stall Freq 3	Stall frequency2-Stall frequency4(Hz)	60.00	O/A	O	O	<u>p.200</u>
56	0h1B38	Stall level3	Stall Level 3	30-250(%)	180	X/A	O	O	<u>p.200</u>
57	0h1B39	Stall frequency4	Stall Freq 4	Stall frequency3-Maximum frequency(Hz)	60.00	O/A	O	O	<u>p.200</u>
58	0h1B3A	Stall level4	Stall Level 4	30-250(%)	180	X/A	O	O	<u>p.200</u>
59	0h1B3B	Flux braking gain	Flux Brake Kp	0 ~ 150[%]	0	O/A	O	O	-
60	0h1B3C	CAP diagnosis level	CAP. Diag Perc	10 ~ 100[%]	0	O/A	O	O	-
61 ⁵³	0h1B3D	CAP diagnosis mode	CAP. Diag	0	None	0	X/A	O	-
				1	Ref Diag				
				2	Pre Diag				
				3	Init Diag				
62 ⁵³	0h1B3E	CAP Exchange Level	CAP Exchange Level	50.0 ~ 95.0[%]	0	X/A	O	O	-
63 ⁵³	0h1B3F	CAP Diag Level	CAP Diag Level	0.0~100.0[%]	100.0	-/A	O	O	-
66	0h1B42	DB resistor warning level	DB Warn %ED	0-30(%)	0	O/A	O	O	<u>p.208</u>
73	0h1B22	Speed deviation trip	Speed Dev Trip	0	No	0:No	O/A	O	O
				1	Yes				
74	0h1B23	Speed deviation band	Speed Dev Band	1 ~ 20	5	O/A	O	O	

Function Table

⁵³ The Pr.61-63 codes are displayed when the Pr.60(CAP.DiagPrec) is set to more than 0.

Table of Functions

Code	Comm. Address	Name	LCD Display	Setting Range	Initial Value	Property *	V/F	SL	Ref.	
75	0h1B24	Speed deviation time	Speed Dev Time	0~120	60	O/A	O	O		
79	0h1B4F	Cooling fan fault selection	FAN Trip Mode	0	Trip	0:Trip	O/A	O	O	p.211
				1	Warning					
80	0h1B50	Motion selection at option trip	Opt Trip Mode	0	None	1:Free-Run	O/A	O	O	p.215
				1	Free-Run					
				2	Dec					
81	0h1B51	Low voltage fault decision delay time	LVT Delay	0.0-60.0(s)	0.0	X/A	O	O	p.211	
82	0h1B52	LV2 Selection	LV2 Enable	0	No	0	X/A	O	O	-
				1	Yes					
86	0h1B56	Accumulated percent of fan usage	Fan Time Perc	0.0~100.0[%]	0.0	-/A	O	O	-	
87	0h1B57	Fan exchange warning level	Fan Exchange level	0.0~100.0[%]	90.0	O/A	O	O	-	
88 ⁵⁴	0h1B58	Fan reset time	Fan Time Rst	0	No	0	X/A	O	O	-
				1	Yes					
89	0h1B59	CAP, FAN Status	CAP, FAN State	Bit 00	00~10	0	-/A	O	O	-
				00	-					
				01	CAP Warning					
				10	FAN Warning					
90 ⁵⁴	0h1B5A	Warning information	-	-	-	-/7	O	O	-	
91 ⁵⁴	0h1B5B	Fault history 1	-	-	-	-/7	O	O	-	
92 ⁵⁴	0h1B5C	Fault history 2	-	-	-	-/7	O	O	-	
93 ⁵⁴	0h1B5D	Fault history 3	-	-	-	-/7	O	O	-	
94 ⁵⁴	0h1B5E	Fault history 4	-	-	-	-/7	O	O	-	
95 ⁵⁴	0h1B5F	Fault history 5	-	-	-	-/7	O	O	-	
96 ⁵⁴	0h1B60	Fault history deletion	-	0	No	0:No	-/7	O	O	-
				1	Yes					

⁵⁴ Will not be displayed when an LCD keypad is in use.

8.11 2nd Motor Function group (PAR→M2)

The 2nd Motor function group will be displayed if any of In.65-71 are set to 26 (2nd MOTOR). In the following table, the data shaded in grey will be displayed when a related code has been selected.

SL: Sensorless vector control (dr.09)

***O/X:** Write-enabled during operation, **7/L/A:** Keypad/LCD keypad/Common

Code	Comm. Address	Name	LCD Display	Setting Range	Initial Value	Property*	V/F	SL	Ref.	
00	-	Jump Code	Jump Code	1-99	14	O/A	O	O	p.48	
04	0h1C04	Acceleration time	M2-Acc Time	0.0-600.0(s)	20.0	O/A	O	O	p.166	
05	0h1C05	Deceleration time	M2-Dec Time	0.0-600.0(s)	30.0	O/A	O	O	p.166	
06	0h1C06	Motor capacity	M2-Capacity	0	0.2 kW	-	X/A	O	O	p.166
				1	0.4 kW					
				2	0.75 kW					
				3	1.1 kW					
				4	1.5 kW					
				5	2.2 kW					
				6	3.0 kW					
				7	3.7 kW					
				8	4.0 kW					
				9	5.5 kW					
				10	7.5 kW					
				11	11.0 kW					
				12	15.0 kW					
				13	18.5 kW					
				14	22.0 kW					
15	30.0 kW									
07	0h1C07	Base frequency	M2-Base Freq	30.00-400.00(Hz)	60.00	X/A	O	O	p.166	
08	0h1C08	Control mode	M2-Ctrl Mode	0	V/F	0:V/F	X/A	O	O	p.166
				2	Slip Compen					
				4	IM Sensorless					
10	0h1C0A	Number of motor poles	M2-Pole Num	2-48	Dependent	X/A	O	O	p.166	
11	0h1C0B	Rated slip speed	M2-Rated Slip	0-3000(rpm)	on motor setting	X/A	O	O	p.166	
12	0h1C0C	Motor rated current	M2-Rated Curr	1.0-1000.0(A)		X/A	O	O	p.166	

Table of Functions

Code	Comm. Address	Name	LCD Display	Setting Range	Initial Value	Property*	V/F	SL	Ref.	
13	0h1C0D	Motor no-load current	M2-NoLoad Curr	0.5-1000.0(A)	9 ^s	X/A	O	O	p.166	
14	0h1C0E	Motor rated voltage	M2-Rated Volt	170-480(V)		X/A	O	O	p.166	
15	0h1C0F	Motor efficiency	M2-Efficiency	70-100(%)		X/A	O	O	p.166	
16	0h1C10	Load inertia rate	M2-Inertia Rt	0-8		X/A	O	O	p.166	
17	-	Stator resistance	M2-Rs	Dependent on motor settings		X/A	O	O	p.166	
18	-	Leakage inductance	M2-Lsigma			X/A	O	O	p.166	
19	-	Stator inductance	M2-Ls			X/A	O	O	p.166	
20 ⁵⁵	-	Rotor time constant	M2-Tr			25-5000(ms)	X/A	O	O	p.166
25	0h1C19	V/F pattern	M2-V/F Patt	0	Linear	0: Linear	X/A	O	O	p.166
				1	Square					
				2	User V/F					
26	0h1C1A	Forward Torque boost	M2-Fwd Boost	0.0-15.0(%)	2.0	X/A	O	O	p.166	
27	0h1C1B	Reverse Torque boost	M2-Rev Boost	0.0-15.0(%)		X/A	O	O	p.166	
28	0h1C1C	Stall prevention level	M2-Stall Lev	30-150(%)	150	X/A	O	O	p.166	
29	0h1C1D	Electronic thermal 1 minute rating	M2-ETH 1min	100-200(%)	150	X/A	O	O	p.166	
30	0h1C1E	Electronic thermal continuous rating	M2-ETH Cont	50-150(%)	100	X/A	O	O	p.166	

⁵⁵ Displayed when M2.08 is set to 4 (IM Sensorless).

8.12 User Sequence group (US)

This group appears when AP.02 is set to 1 (Yes) or CM.95 is set to 2 (P2P Master). The parameter cannot be changed while the user sequence is running.

SL: Sensorless vector control function (dr.09)

***O/X:** Write-enabled during operation, **7/L/A:** keypad/LCD keypad/common

Code	Comm. Address	Name	LCD Display	Setting Range	Initial Value	Property*	V/F	SL	Ref.	
00	-	Jump code	Jump Code	1-99	31	O/A	O	O	p.48	
01	0h1D01	User sequence operation command	User Seq Con	0	Stop	0:Stop	X/A	O	O	p.111
				1	Run					
				2	Digital In Run					
02	0h1D02	User sequence operation loop time	US Loop Time	0	0.01s	1:0.02s	X/A	O	O	p.111
				1	0.02s					
				2	0.05s					
				3	0.1s					
				4	0.5s					
				5	1s					
11	0h1D0B	Output address link1	Link UserOut1	0-0xFFFF	0	X/A	O	O	p.111	
12	0h1D0C	Output address link2	Link UserOut2	0-0xFFFF	0	X/A	O	O	p.111	
13	0h1D0D	Output address link3	Link UserOut3	0-0xFFFF	0	X/A	O	O	p.111	
14	0h1D0E	Output address link4	Link UserOut4	0-0xFFFF	0	X/A	O	O	p.111	
15	0h1D0F	Output address link5	Link UserOut5	0-0xFFFF	0	X/A	O	O	p.111	
16	0h1D10	Output address link6	Link UserOut6	0-0xFFFF	0	X/A	O	O	p.111	
17	0h1D11	Output address link7	Link UserOut7	0-0xFFFF	0	X/A	O	O	p.111	
18	0h1D12	Output address link8	Link UserOut8	0-0xFFFF	0	X/A	O	O	p.111	
19	0h1D13	Output address link9	Link UserOut9	0-0xFFFF	0	X/A	O	O	p.111	
20	0h1D14	Output address link10	Link UserOut10	0-0xFFFF	0	X/A	O	O	p.111	
21	0h1D15	Output address link11	Link UserOut11	0-0xFFFF	0	X/A	O	O	p.111	
22	0h1D16	Output address link12	Link UserOut12	0-0xFFFF	0	X/A	O	O	p.111	

Table of Functions

Code	Comm. Address	Name	LCD Display	Setting Range	Initial Value	Property*	V/F	SL	Ref.
23	0h1D17	Output address link13	Link UserOut13	0-0xFFFF	0	X/A	O	O	p.111
24	0h1D18	Output address link14	Link UserOut14	0-0xFFFF	0	X/A	O	O	p.111
25	0h1D19	Output address link15	Link UserOut15	0-0xFFFF	0	X/A	O	O	p.111
26	0h1D1A	Output address link16	Link UserOut16	0-0xFFFF	0	X/A	O	O	p.111
27	0h1D1B	Output address link17	Link UserOut17	0-0xFFFF	0	X/A	O	O	p.111
28	0h1D1C	Output address link18	Link UserOut18	0-0xFFFF	0	X/A	O	O	p.111
31	0h1D1F	Input constant setting1	Void Para1	-9999-9999	0	X/A	O	O	p.111
32	0h1D20	Input constant setting2	Void Para2	-9999-9999	0	X/A	O	O	p.111
33	0h1D21	Input constant setting3	Void Para3	-9999-9999	0	X/A	O	O	p.111
34	0h1D22	Input constant setting4	Void Para4	-9999-9999	0	X/A	O	O	p.111
35	0h1D23	Input constant setting5	Void Para5	-9999-9999	0	X/A	O	O	p.111
36	0h1D24	Input constant setting6	Void Para6	-9999-9999	0	X/A	O	O	p.111
37	0h1D25	Input constant setting7	Void Para7	-9999-9999	0	X/A	O	O	p.111
38	0h1D26	Input constant setting8	Void Para8	-9999-9999	0	X/A	O	O	p.111
39	0h1D27	Input constant setting9	Void Para9	-9999-9999	0	X/A	O	O	p.111
40	0h1D28	Input constant setting10	Void Para10	-9999-9999	0	X/A	O	O	p.111
41	0h1D29	Input constant setting11	Void Para11	-9999-9999	0	X/A	O	O	p.111
42	0h1D2A	Input constant setting12	Void Para12	-9999-9999	0	X/A	O	O	p.111
43	0h1D2B	Input constant setting13	Void Para13	-9999-9999	0	X/A	O	O	p.111
44	0h1D2C	Input constant setting14	Void Para14	-9999-9999	0	X/A	O	O	p.111
45	0h1D2D	Input constant setting15	Void Para15	-9999-9999	0	X/A	O	O	p.111

Code	Comm. Address	Name	LCD Display	Setting Range	Initial Value	Property*	V/F	SL	Ref.
46	0h1D2E	Input constant setting16	Void Para16	-9999-9999	0	X/A	O	O	p.111
47	0h1D2F	Input constant setting17	Void Para17	-9999-9999	0	X/A	O	O	p.111
48	0h1D30	Input constant setting18	Void Para18	-9999-9999	0	X/A	O	O	p.111
49	0h1D31	Input constant setting19	Void Para19	-9999-9999	0	X/A	O	O	p.111
50	0h1D32	Input constant setting20	Void Para20	-9999-9999	0	X/A	O	O	p.111
51	0h1D33	Input constant setting21	Void Para21	-9999-9999	0	X/A	O	O	p.111
52	0h1D34	Input constant setting22	Void Para22	-9999-9999	0	X/A	O	O	p.111
53	0h1D35	Input constant setting23	Void Para23	-9999-9999	0	X/A	O	O	p.111
54	0h1D36	Input constant setting24	Void Para24	-9999-9999	0	X/A	O	O	p.111
55	0h1D37	Input constant setting25	Void Para25	-9999-9999	0	X/A	O	O	p.111
56	0h1D38	Input constant setting26	Void Para26	-9999-9999	0	X/A	O	O	p.111
57	0h1D39	Input constant setting27	Void Para27	-9999-9999	0	X/A	O	O	p.111
58	0h1D3A	Input constant setting28	Void Para28	-9999-9999	0	X/A	O	O	p.111
59	0h1D3B	Input constant setting29	Void Para29	-9999-9999	0	X/A	O	O	p.111
60	0h1D3C	Input constant setting30	Void Para30	-9999-9999	0	X/A	O	O	p.111
80	0h1D50S	Analog input 1	P2P In V1	0-12,000		-/A	O	O	p.111
81	0h1D51	Analog input2	P2P In I2	-12,000-12,000		-/A	O	O	p.111
82	0h1D52	Digital input	P2P In DI	0-0x7F		-/A	O	O	p.111
85	0h1D55	Analog output	P2P OutAO1	0-10,000	0	X/A	O	O	p.111
88	0h1D58	Digital output	P2P OutDO	0-0x03	0	X/A	O	O	p.111

8.13 User Sequence Function group(UF)

This group appears when AP.02 is set to 1 (Yes) or CM.95 is set to 2 (P2P Master). The parameter cannot be changed while the user sequence is running.

SL: Sensorless vector control function (dr.09)

***O/X:** Write-enabled during operation, **7/L/A:** keypad/LCD keypad/common

Code	Comm. Address	Name	LCD Display	Setting Range	Initial Value	Property*	V/F	SL	Ref.	
00	-	Jump code	Jump Code	1-99	41	O/A	O	O	p.48	
01	0h1E01	User function1	User Func1	0	NOP	0:NOP	X/A	O	O	p.111
				1	ADD					
				2	SUB					
				3	ADDSUB					
				4	MIN					
				5	MAX					
				6	ABS					
				7	NEGATE					
				8	MPYDIV					
				9	REMAINDER					
				10	COMPARE-GT					
				11	COMPARE-GEQ					
				12	COMPARE-EQUAL					
				13	COMPARE-NEQUAL					
				14	TIMER					
				15	LIMIT					
				16	AND					
				17	OR					
				18	XOR					
				19	ANDOR					
				20	SWITCH					
				21	BITTEST					
				22	BITSET					
				23	BITCLEAR					
				24	LOWPASSFILTER					
				25	PI_CONTORL					

Code	Comm. Address	Name	LCD Display	Setting Range	Initial Value	Property*	V/F	SL	Ref.
				26 PI_PROCESS					
				27 UPCOUNT					
				28 DOWNCOUNT					
02	0h1E02	User function input1-A	User Input1-A	0-0xFFFF	0	X/A	O	O	<u>p.111</u>
03	0h1E03	User function input1-B	User Input1-B	0-0xFFFF	0	X/A	O	O	<u>p.111</u>
04	0h1E04	User function input1-C	User Input1-C	0-0xFFFF	0	X/A	O	O	<u>p.111</u>
05	0h1E05	User function output1	User Output1	-32767-32767	0	-/A	O	O	<u>p.111</u>
06	0h1E06	User function 2	User Func2	0 NOP	0:NOP	X/A	O	O	<u>p.111</u>
				1 ADD					
				2 SUB					
				3 ADDSUB					
				4 MIN					
				5 MAX					
				6 ABS					
				7 NEGATE					
				8 MPYDIV					
				9 REMAINDER					
				10 COMPARE-GT					
				11 COMPARE-GEQ					
				12 COMPARE-EQUAL					
				13 COMPARE-NEQUAL					
				14 TIMER					
				15 LIMIT					
				16 AND					
				17 OR					
				18 XOR					
				19 ANDOR					
				20 SWITCH					
				21 BITTEST					
				22 BITSET					
				23 BITCLEAR					

Table of Functions

Code	Comm. Address	Name	LCD Display	Setting Range	Initial Value	Property*	V/F	SL	Ref.	
				24	LOWPASSFILTER					
				25	PI_CONTORL					
				26	PI_PROCESS					
				27	UPCOUNT					
				28	DOWNCOUNT					
07	0h1E07	User function input2-A	User Input2-A	0-0xFFFF		0	X/A	O	O	<u>p.111</u>
08	0h1E08	User function input2-B	User Input2-B	0-0xFFFF		0	X/A	O	O	<u>p.111</u>
09	0h1E09	User function input2-C	User Input2-C	0-0xFFFF		0	X/A	O	O	<u>p.111</u>
10	0h1E0A	User function output2	User Output2	-32767-32767		0	-/A	O	O	<u>p.111</u>
11	0h1E0B	User function3	User Func3	0	NOP	0:NOP	X/A	O	O	<u>p.111</u>
				1	ADD					
				2	SUB					
				3	ADDSUB					
				4	MIN					
				5	MAX					
				6	ABS					
				7	NEGATE					
				8	MPYDIV					
				9	REMAINDER					
				10	COMPARE-GT					
				11	COMPARE-GEQ					
				12	COMPARE-EQUAL					
				13	COMPARE-NEQUAL					
				14	TIMER					
				15	LIMIT					
				16	AND					
17	OR									
18	XOR									
19	ANDOR									
20	SWITCH									
21	BITTEST									

Code	Comm. Address	Name	LCD Display	Setting Range	Initial Value	Property*	V/F	SL	Ref.
				22 BITSET					
				23 BITCLEAR					
				24 LOWPASSFILTER					
				25 PI_CONTORL					
				26 PI_PROCESS					
				27 UPCOUNT					
				28 DOWNCOUNT					
12	0h1E0C	User function input3-A	User Input3-A	0-0xFFFF	0	X/A	O	O	<u>p.111</u>
13	0h1E0D	User function input3-B	User Input3-B	0-0xFFFF	0	X/A	O	O	<u>p.111</u>
14	0h1E0E	User function input3-C	User Input3-C	0-0xFFFF	0	X/A	O	O	<u>p.111</u>
15	0h1E0F	User function output3	User Output3	-32767-32767	0	-/A	O	O	<u>p.111</u>
16	0h1E10	User function4	User Func4	0 NOP	0:NOP	X/A	O	O	<u>p.111</u>
1				ADD					
2				SUB					
3				ADDSUB					
4				MIN					
5				MAX					
6				ABS					
7				NEGATE					
8				MPYDIV					
9				REMAINDER					
10				COMPARE-GT					
11				COMPARE-GEQ					
12				COMPARE-EQUAL					
13				COMPARE-NEQUAL					
14				TIMER					
15				LIMIT					
16				AND					
17	OR								
18	XOR								
19	ANDOR								

Function Table

Table of Functions

Code	Comm. Address	Name	LCD Display	Setting Range	Initial Value	Property*	V/F	SL	Ref.	
				20 SWITCH						
				21 BITTEST						
				22 BITSET						
				23 BITCLEAR						
				24 LOWPASSFILTER						
				25 PI_CONTORL						
				26 PI_PROCESS						
				27 UPCOUNT						
				28 DOWNCOUNT						
17	0h1E11	User function input4-A	User Input4-A	0-0xFFFF	0	X/A	O	O	<u>p.111</u>	
18	0h1E12	User function input4-B	User Input4-B	0-0xFFFF	0	X/A	O	O	<u>p.111</u>	
19	0h1E13	User function input4-C	User Input4-C	0-0xFFFF	0	X/A	O	O	<u>p.111</u>	
20	0h1E14	User function output4	User Output4	-32767-32767	0	-/A	O	O	<u>p.111</u>	
21	0h1E15	User function5	User Func5	0	NOP	0:NOP	X/A	O	O	<u>p.111</u>
1				ADD						
2				SUB						
3				ADDSUB						
4				MIN						
5				MAX						
6				ABS						
7				NEGATE						
8				MPYDIV						
9				REMAINDER						
10				COMPARE-GT						
11				COMPARE-GEQ						
12				COMPARE-EQUAL						
13				COMPARE-NEQUAL						
14				TIMER						
15				LIMIT						
16				AND						
17				OR						
18				XOR						
19	ANDOR									

Code	Comm. Address	Name	LCD Display	Setting Range	Initial Value	Property*	V/F	SL	Ref.	
				20 SWITCH						
				21 BITTEST						
				22 BITSET						
				23 BITCLEAR						
				24 LOWPASSFILTER						
				25 PI_CONTORL						
				26 PI_PROCESS						
				27 UPCOUNT						
				28 DOWNCOUNT						
22	0h1E16	User function input5-A	User Input5-A	0-0xFFFF	0	X/A	O	O	<u>p.111</u>	
23	0h1E17	User function input5-B	User Input5-B	0-0xFFFF	0	X/A	O	O	<u>p.111</u>	
24	0h1E18	User function input5-C	User Input5-C	0-0xFFFF	0	X/A	O	O	<u>p.111</u>	
25	0h1E19	User function output5	User Output5	-32767-32767	0	-/A	O	O	<u>p.111</u>	
26	0h1E1A	User function6	User Func6	0	NOP	0:NOP	X/A	O	O	<u>p.111</u>
1				ADD						
2				SUB						
3				ADDSUB						
4				MIN						
5				MAX						
6				ABS						
7				NEGATE						
8				MPYDIV						
9				REMAINDER						
10				COMPARE-GT						
11				COMPARE-GEQ						
12				COMPARE-EQUAL						
13				COMPARE-NEQUAL						
14				TIMER						
15				LIMIT						
16				AND						
17	OR									

Table of Functions

Code	Comm. Address	Name	LCD Display	Setting Range	Initial Value	Property*	V/F	SL	Ref.	
				18 XOR						
				19 ANDOR						
				20 SWITCH						
				21 BITTEST						
				22 BITSET						
				23 BITCLEAR						
				24 LOWPASSFILTER						
				25 PI_CONTORL						
				26 PI_PROCESS						
				27 UPCOUNT						
				28 DOWNCOUNT						
27	0h1E1B	User function input6-A	User Input6-A	0-0xFFFF	0	X/A	O	O	p.111	
28	0h1E1C	User function input6-B	User Input6-B	0-0xFFFF	0	X/A	O	O	p.111	
29	0h1E1D	User function input6-C	User Input6-C	0-0xFFFF	0	X/A	O	O	p.111	
30	0h1E1E	User function output6	User Output6	-32767-32767	0	-/A	O	O	p.111	
31	0h1E1F	User function7	User Func7	0	NOP	0:NOP	X/A	O	O	p.111
				1	ADD					
				2	SUB					
				3	ADDSUB					
				4	MIN					
				5	MAX					
				6	ABS					
				7	NEGATE					
				8	MPYDIV					
				9	REMAINDER					
				10	COMPARE-GT					
				11	COMPARE-GEQ					
				12	COMPARE-EQUAL					
				13	COMPARE-					
				14	TIMER					
	15	LIMIT								

Code	Comm. Address	Name	LCD Display	Setting Range	Initial Value	Property*	V/F	SL	Ref.	
				16 AND						
				17 OR						
				18 XOR						
				19 ANDOR						
				20 SWITCH						
				21 BITTEST						
				22 BITSET						
				23 BITCLEAR						
				24 LOWPASSFILTER						
				25 PI_CONTORL						
				26 PI_PROCESS						
				27 UPCOUNT						
				28 DOWNCOUNT						
32	0h1E20	User function input7-A	User Input7-A	0-0xFFFF	0	X/A	O	O	<u>p.111</u>	
33	0h1E21	User function input7-B	User Input7-B	0-0xFFFF	0	X/A	O	O	<u>p.111</u>	
34	0h1E22	User function input7-C	User Input7-C	0-0xFFFF	0	X/A	O	O	<u>p.111</u>	
35	0h1E23	User function output7	User Output7	-32767-32767	0	-/A	O	O	<u>p.111</u>	
36	0h1E24	User function8	User Func8	0	NOP	0:NOP	X/A	O	O	<u>p.111</u>
				1	ADD					
				2	SUB					
				3	ADDSUB					
				4	MIN					
				5	MAX					
				6	ABS					
				7	NEGATE					
				8	MPYDIV					
				9	REMAINDER					
				10	COMPARE-GT					
				11	COMPARE-GEQ					
				12	COMPARE-EQUAL					
				13	COMPARE-NEQUAL					

Function Table

Table of Functions

Code	Comm. Address	Name	LCD Display	Setting Range	Initial Value	Property*	V/F	SL	Ref.	
				14	TIMER					
				15	LIMIT					
				16	AND					
				17	OR					
				18	XOR					
				19	ANDOR					
				20	SWITCH					
				21	BITTEST					
				22	BITSET					
				23	BITCLEAR					
				24	LOWPASSFILTER					
				25	PI_CONTORL					
				26	PI_PROCESS					
				27	UPCOUNT					
				28	DOWNCOUNT					
37	0h1E25	User function input8-A	User Input8-A	0-0xFFFF	0	X/A	0	0	p.111	
38	0h1E26	User function input8-B	User Input8-B	0-0xFFFF	0	X/A	0	0	p.111	
39	0h1E27	User function input8-C	User Input8-C	0-0xFFFF	0	X/A	0	0	p.111	
40	0h1E28	User function output8	User Output8	-32767-32767	0	-/A	0	0	p.111	
41	0h1E29	User function9	User Func9	0	NOP	0:NOP	X/A	0	0	p.111
1				ADD						
2				SUB						
3				ADDSUB						
4				MIN						
5				MAX						
6				ABS						
7				NEGATE						
8				MPYDIV						
9				REMAINDER						
10				COMPARE-GT						
11				COMPARE-GEQ						
12				COMPARE-EQUAL						

Code	Comm. Address	Name	LCD Display	Setting Range	Initial Value	Property*	V/F	SL	Ref.	
				13 COMPARE-NEQUAL						
				14 TIMER						
				15 LIMIT						
				16 AND						
				17 OR						
				18 XOR						
				19 ANDOR						
				20 SWITCH						
				21 BITTEST						
				22 BITSET						
				23 BITCLEAR						
				24 LOWPASSFILTER						
				25 PI_CONTORL						
				26 PI_PROCESS						
				27 UPCOUNT						
				28 DOWNCOUNT						
42	0h1E2A	User function input9-A	User Input9-A	0-0xFFFF	0	X/A	O	O	<u>p.111</u>	
43	0h1E2B	User function input9-B	User Input9-B	0-0xFFFF	0	X/A	O	O	<u>p.111</u>	
44	0h1E2C	User function input9-C	User Input9-C	0-0xFFFF	0	X/A	O	O	<u>p.111</u>	
45	0h1E2D	User function output9	User Output9	-32767-32767	0	-/A	O	O	<u>p.111</u>	
46	0h1E2E	User function10	User Func10	0	NOP	0:NOP	X/A	O	O	<u>p.111</u>
1				ADD						
2				SUB						
3				ADDSUB						
4				MIN						
5				MAX						
6				ABS						
7				NEGATE						
8				MPYDIV						
9				REMAINDER						
10				COMPARE-GT						
11				COMPARE-GEQ						

Function Table

Table of Functions

Code	Comm. Address	Name	LCD Display	Setting Range	Initial Value	Property*	V/F	SL	Ref.
				12 COMPARE-EQUAL					
				13 COMPARE-NEQUAL					
				14 TIMER					
				15 LIMIT					
				16 AND					
				17 OR					
				18 XOR					
				19 ANDOR					
				20 SWITCH					
				21 BITTEST					
				22 BITSET					
				23 BITCLEAR					
				24 LOWPASSFILTER					
				25 PI_CONTORL					
				26 PI_PROCESS					
				27 UPCOUNT					
				28 DOWNCOUNT					
47	0h1E2F	User function input10-A	User Input10-A	0-0xFFFF	0	X/A	O	O	<u>p.111</u>
48	0h1E30	User function input10-B	User Input10-B	0-0xFFFF	0	X/A	O	O	<u>p.111</u>
49	0h1E31	User function input10-C	User Input10-C	0-0xFFFF	0	X/A	O	O	<u>p.111</u>
50	0h1E32	User function output10	User Output10	-32767-32767	0	-/A	O	O	<u>p.111</u>
51	0h1E33	User function11	User Func11	0 NOP	0:NOP	X/A	O	O	<u>p.111</u>
				1 ADD					
				2 SUB					
				3 ADDSUB					
				4 MIN					
				5 MAX					
				6 ABS					
				7 NEGATE					

Code	Comm. Address	Name	LCD Display	Setting Range	Initial Value	Property*	V/F	SL	Ref.
				8 MPYDIV					
				9 REMAINDER					
				10 COMPARE-GT					
				11 COMPARE-GEQ					
				12 COMPARE-EQUAL					
				13 COMPARE-NEQUAL					
				14 TIMER					
				15 LIMIT					
				16 AND					
				17 OR					
				18 XOR					
				19 ANDOR					
				20 SWITCH					
				21 BITTEST					
				22 BITSET					
				23 BITCLEAR					
				24 LOWPASSFILTER					
				25 PI_CONTORL					
				26 PI_PROCESS					
				27 UPCOUNT					
				28 DOWNCOUNT					
52	0h1E34	User function input11-A	User Input11-A	0-0xFFFF	0	X/A	O	O	<u>p.111</u>
53	0h1E35	User function input11-B	User Input11-B	0-0xFFFF	0	X/A	O	O	<u>p.111</u>
54	0h1E36	User function input11-C	User Input11-C	0-0xFFFF	0	X/A	O	O	<u>p.111</u>
55	0h1E37	User function output11	User Output11	-32767-32767	0	-/A	O	O	<u>p.111</u>
56	0h1E38	User function12	User Func12	0 NOP	0:NOP	X/A	O	O	<u>p.111</u>
				1 ADD					
				2 SUB					
				3 ADDSUB					

Function Table

Table of Functions

Code	Comm. Address	Name	LCD Display	Setting Range	Initial Value	Property*	V/F	SL	Ref.
				4 MIN					
				5 MAX					
				6 ABS					
				7 NEGATE					
				8 MPYDIV					
				9 REMAINDER					
				10 COMPARE-GT					
				11 COMPARE-GEQ					
				12 COMPARE-EQUAL					
				13 COMPARE-NEQUAL					
				14 TIMER					
				15 LIMIT					
				16 AND					
				17 OR					
				18 XOR					
				19 ANDOR					
				20 SWITCH					
				21 BITTEST					
				22 BITSET					
				23 BITCLEAR					
				24 LOWPASSFILTER					
				25 PI_CONTORL					
				26 PI_PROCESS					
				27 UPCOUNT					
				28 DOWNCOUNT					
57	0h1E39	User function input12-A	User Input12-A	0-0xFFFF	0	X/A	O	O	<u>p.111</u>
58	0h1E3A	User function input12-B	User Input12-B	0-0xFFFF	0	X/A	O	O	<u>p.111</u>
59	0h1E3B	User function input12-C	User Input12-C	0-0xFFFF	0	X/A	O	O	<u>p.111</u>
60	0h1E3C	User function output12	User Output12	-32767-32767	0	-/A	O	O	<u>p.111</u>

Code	Comm. Address	Name	LCD Display	Setting Range	Initial Value	Property*	V/F	SL	Ref.	
61	0h1E3D	User function13	User Func13	0	NOP	0:NOP	X/A	O	O	p.111
				1	ADD					
				2	SUB					
				3	ADDSUB					
				4	MIN					
				5	MAX					
				6	ABS					
				7	NEGATE					
				8	MPYDIV					
				9	REMAINDER					
				10	COMPARE-GT					
				11	COMPARE-GEQ					
				12	COMPARE-EQUAL					
				13	COMPARE-NEQUAL					
				14	TIMER					
				15	LIMIT					
				16	AND					
				17	OR					
				18	XOR					
				19	ANDOR					
				20	SWITCH					
				21	BITTEST					
				22	BITSET					
				23	BITCLEAR					
				24	LOWPASSFILTER					
				25	PI_CONTORL					
				26	PI_PROCESS					
				27	UPCOUNT					
				28	DOWNCOUNT					
62	0h1E3E	User function input13-A	User Input13-A	0-0xFFFF	0	X/A	O	O	p.111	
63	0h1E3F	User function input13-B	User Input13-B	0-0xFFFF	0	X/A	O	O	p.111	

Table of Functions

Code	Comm. Address	Name	LCD Display	Setting Range	Initial Value	Property*	V/F	SL	Ref.	
64	0h1E40	User function input13-C	User Input13-C	0-0xFFFF	0	X/A	O	O	p.111	
65	0h1E41	User function output13	User Output13	-32767-32767	0	-/A	O	O	p.111	
66	0h1E42	User function14	User Func14	0	NOP	0:NOP	X/A	O	O	p.111
				1	ADD					
				2	SUB					
				3	ADDSUB					
				4	MIN					
				5	MAX					
				6	ABS					
				7	NEGATE					
				8	MPYDIV					
				9	REMAINDER					
				10	COMPARE-GT					
				11	COMPARE-GEQ					
				12	COMPARE-EQUAL					
				13	COMPARE-NEQUAL					
				14	TIMER					
				15	LIMIT					
				16	AND					
				17	OR					
				18	XOR					
				19	ANDOR					
				20	SWITCH					
				21	BITTEST					
				22	BITSET					
				23	BITCLEAR					
				24	LOWPASSFILTER					
				25	PI_CONTORL					
				26	PI_PROCESS					
				27	UPCOUNT					
				28	DOWNCOUNT					
67	0h1E43	User function	User	0-0xFFFF	0	X/A	O	O	p.111	

Code	Comm. Address	Name	LCD Display	Setting Range	Initial Value	Property*	V/F	SL	Ref.	
		input14-A	Input14-A							
68	0h1E44	User function input14-B	User Input14-B	0-0xFFFF	0	X/A	O	O	p.111	
69	0h1E45	User function input14-C	User Input14-C	0-0xFFFF	0	X/A	O	O	p.111	
70	0h1E46	User function output14	User Output14	-32767-32767	0	-/A	O	O	p.111	
71	0h1E47	User function15	User Func15	0	NOP	0:NOP	X/A	O	O	p.111
1				ADD						
2				SUB						
3				ADDSUB						
4				MIN						
5				MAX						
6				ABS						
7				NEGATE						
8				MPYDIV						
9				REMAINDER						
10				COMPARE-GT						
11				COMPARE-GEQ						
12				COMPARE-EQUAL						
13				COMPARE-NEQUAL						
14				TIMER						
15				LIMIT						
16				AND						
17				OR						
18				XOR						
19				ANDOR						
20				SWITCH						
21				BITTEST						
22				BITSET						
23				BITCLEAR						
24				LOWPASSFILTER						
25				PI_CONTORL						

Table of Functions

Code	Comm. Address	Name	LCD Display	Setting Range	Initial Value	Property*	V/F	SL	Ref.
				26 PI_PROCESS					
				27 UPCOUNT					
				28 DOWNCOUNT					
72	0h1E48	User function input15-A	User Input15-A	0-0xFFFF	0	X/A	O	O	<u>p.111</u>
73	0h1E49	User function input15-B	User Input15-B	0-0xFFFF	0	X/A	O	O	<u>p.111</u>
74	0h1E4A	User function input15-C	User Input15-C	0-0xFFFF	0	X/A	O	O	<u>p.111</u>
75	0h1E4B	User function output15	User Output15	-32767-32767	0	-/A	O	O	<u>p.111</u>
76	0h1E4C	User function 16	User Func16	0 NOP	0:NOP	X/A	O	O	<u>p.111</u>
1 ADD									
2 SUB									
3 ADDSUB									
4 MIN									
5 MAX									
6 ABS									
7 NEGATE									
8 MPYDIV									
9 REMAINDER									
10 COMPARE-GT									
11 COMPARE-GEQ									
12 COMPARE-EQUAL									
13 COMPARE-NEQUAL									
14 TIMER									
15 LIMIT									
16 AND									
17 OR									
18 XOR									
19 ANDOR									
20 SWITCH									
21 BITTEST									

Code	Comm. Address	Name	LCD Display	Setting Range	Initial Value	Property*	V/F	SL	Ref.
				22 BITSET					
				23 BITCLEAR					
				24 LOWPASSFILTER					
				25 PI_CONTORL					
				26 PI_PROCESS					
				27 UPCOUNT					
				28 DOWNCOUNT					
77	0h1E4D	User function input16-A	User Input16-A	0-0xFFFF	0	X/A	O	O	<u>p.111</u>
78	0h1E4E	User function input16-B	User Input16-B	0-0xFFFF	0	X/A	O	O	<u>p.111</u>
79	0h1E4F	User function input16-C	User Input16-C	0-0xFFFF	0	X/A	O	O	<u>p.111</u>
80	0h1E50	User function output16	User Output16	-32767-32767	0	-/A	O	O	<u>p.111</u>
81	0h1E51	User function 17	User Func17	0 NOP	0:NOP	X/A	O	O	<u>p.111</u>
1 ADD									
2 SUB									
3 ADDSUB									
4 MIN									
5 MAX									
6 ABS									
7 NEGATE									
8 MPYDIV									
9 REMAINDER									
10 COMPARE-GT									
11 COMPARE-GEQ									
12 COMPARE-EQUAL									
13 COMPARE-NEQUAL									
14 TIMER									
15 LIMIT									
16 AND									
17 OR									

Function Table

Table of Functions

Code	Comm. Address	Name	LCD Display	Setting Range	Initial Value	Property*	V/F	SL	Ref.
				18 XOR					
				19 ANDOR					
				20 SWITCH					
				21 BITTEST					
				22 BITSET					
				23 BITCLEAR					
				24 LOWPASSFILTER					
				25 PI_CONTORL					
				26 PI_PROCESS					
				27 UPCOUNT					
				28 DOWNCOUNT					
82	0h1E52	User function input17-A	User Input17-A	0-0xFFFF	0	X/A	O	O	<u>p.111</u>
83	0h1E53	User function input17-B	User Input17-B	0-0xFFFF	0	X/A	O	O	<u>p.111</u>
84	0h1E54	User function input17-C	User Input17-C	0-0xFFFF	0	X/A	O	O	<u>p.111</u>
85	0h1E55	User function output17	User Output17	-32767-32767	0	-/A	O	O	<u>p.111</u>
86	0h1E56	User function 18	User Func18	0 NOP	0:NOP	X/A	O	O	<u>p.111</u>
				1 ADD					
				2 SUB					
				3 ADDSUB					
				4 MIN					
				5 MAX					
				6 ABS					
				7 NEGATE					
				8 MPYDIV					
				9 REMAINDER					
				10 COMPARE-GT					
				11 COMPARE-GEQ					
				12 COMPARE-EQUAL					
				13 COMPARE-NEQUAL					

Code	Comm. Address	Name	LCD Display	Setting Range	Initial Value	Property*	V/F	SL	Ref.
				14	TIMER				
				15	LIMIT				
				16	AND				
				17	OR				
				18	XOR				
				19	ANDOR				
				20	SWITCH				
				21	BITTEST				
				22	BITSET				
				23	BITCLEAR				
				24	LOWPASSFILTER				
				25	PI_CONTORL				
				26	PI_PROCESS				
				27	UPCOUNT				
				28	DOWNCOUNT				
87	0h1E57	User function input18-A	User Input18-A	0-0xFFFF	0	X/A	O	O	<u>p.111</u>
88	0h1E58	User function input18-B	User Input18-B	0-0xFFFF	0	X/A	O	O	<u>p.111</u>
89	0h1E59	User function input18-C	User Input18-C	0-0xFFFF	0	X/A	O	O	<u>p.111</u>
90	0h1E5A	User function output18	User Output18	-32767-32767	0	-/A	O	O	<u>p.111</u>

Function Table

8.14 Groups for LCD Keypad Only

8.14.1 Trip Mode (TRP Last-x)

Code	Name	LCD Display	Setting Range	Initial Value	Ref.
00	Trip type display	Trip Name(x)	-	-	-
01	Frequency reference at trip	Output Freq	-	-	-
02	Output current at trip	Output Current	-	-	-
03	Acceleration/Deceleration state at trip	Inverter State	-	-	-
04	DC section state	DCLink Voltage	-	-	-
05	NTC temperature	Temperature	-	-	-
06	Input terminal state	DI Status	-	0000 0000	-
07	Output terminal state	DO Status	-	000	-
08	Trip time after Power on	Trip On Time	-	0/00/00 00:00	-
09 10	Trip time after operation start	Trip Run Time	-	0/00/00 00:00	-
10	Delete trip history	Trip Delete?	0 No 1 Yes		

8.14.2 Config Mode (CNF)

Code	Name	LCD Display	Setting Range	Initial Value	Ref.
00	Jump code	Jump Code	1-99	42	p.48
01	Keypad language selection	Language Sel	0 : English	0 : English	p.193
02	LCD constrast adjustment	LCD Contrast	-	-	p.176
03	Multi keypad ID	Multi KPD ID	3-99	3	p.109
10	Inverter S/W version	Inv S/W Ver	-	-	p.176
11	LCD keypad S/W version	Keypad S/W Ver	-	-	p.176
12	LCD keypad title version	KPD Title Ver	-	-	p.176
20	Status window display item	Anytime Para	0 Frequency	0: Frequency	p.193

Code	Name	LCD Display	Setting Range		Initial Value	Ref.
21	Monitor mode display item1	Monitor Line-1	1	Speed	0: Frequency	p.193
22	Monitor mode display item2	Monitor Line-2	2	Output Current	2:Output Current	p.193
23	Monitor mode display item3	Monitor Line-3	3	Output	3:Output Voltage	p.193
			4	Output Power		
			5	WHour		
			6	DCLink		
			7	DI State		
			8	DO State		
			9	V1 Monitor(V)		
			10	V1 Monitor(%)		
			13	V2 Monitor(V)		
			14	V2 Monitor(%)		
			15	I2		
			16	I2 Monitor(%)		
			17	PID Output		
			18	PID Ref Value		
19	PID Fdb Value					
20	Torque					
21	Torque Limit					
23	Speed Limit					
24	Monitor mode initialization	Mon Mode Init	0	No	0:No	p.193
			1	Yes		
30	Option slot 1 type display	Option-1 Type	0	None	0:None	p.176
31	Option slot 2 type display	Option-2 Type	6	Ethernet	0:None	p.176
32	Option slot 3 type display	Option-3 Type	9	CANopen	0:None	p.176
40	Parameter initialization	Parameter Init	0	No		p.170
			1	All Grp		
			2	DRV Grp		
			3	BAS Grp		
			4	ADV Grp		
			5	CON Grp		
			6	IN Grp		
			7	OUT Grp		
8	COM Grp					

Table of Functions

Code	Name	LCD Display	Setting Range		Initial Value	Ref.
			9	APP Grp		
			12	PRT Grp		
			13	M2 Grp		
41	Display changed Parameter	Changed Para	0	View All	0:View All	p.173
			1	View Changed		
42	Multi key item	Multi Key Sel	0	None	0:None	p.173
			1	JOG Key		
			2	Local/Remote		
			3	UserGrp SelKey		
43	Macro function item	Macro Select	0	None	0:None	-
			1	None		
44	Trip history deletion	Erase All Trip	0	No	0:No	p.176
			1	Yes		
45	User registration code deletion	UserGrp AllDel	0	No	0:No	p.173
			1	Yes		
46	Read parameters	Parameter Read	0	No	0:No	p.170
			1	Yes		
47	Write parameters	Parameter Write	0	No	0: No	p.170
			1	Yes		
48	Save parameters	Parameter Save	0	No	0:No	p.170
			1	Yes		
50	Hide parameter mode	View Lock Set	0-9999		Un-locked	p.171
51	Password for hiding parameter mode	View Lock Pw	0-9999		Password	p.171
52	Lock parameter edit	Key Lock Set	0-9999		Un-locked	p.172
53	Password for locking parameter edit	Key Lock Pw	0-9999		Password	p.172
60	Additional title update	Add Title Up	0	No	0:No	p.176
			1	Yes		
61	Simple parameter setting	Easy Start On	0	No	1:Yes	p.173
			1	Yes		
62	Power consumption initialization	WHCount Reset	0	No	0:No	p.176
			1	Yes		
70	Accumulated inverter motion time	On-time	Year/month/day hour:minute		-	p.195

Code	Name	LCD Display	Setting Range		Initial Value	Ref.
71	Accumulated inverter operation time	Run-time	Year/month/day hour:minute		-	<u>p.195</u>
72	Accumulated inverter operation time initialization	Time Reset	0	No	0:No	<u>p.195</u>
			1	Yes		
74	Accumulated cooling fan operation time	Fan Time	Year/month/day hour:minute		-	<u>p.195</u>
75	Reset of accumulated cooling fan operation time	Fan Time Rst	0	No	0:No	<u>p.195</u>
			1	Yes		

9 Troubleshooting

This chapter explains how to troubleshoot a problem when inverter protective functions, fault trips, warning signals, or a fault occurs. If the inverter does not work normally after following the suggested troubleshooting steps, please contact the LSIS customer service center.

9.1 Trips and Warnings

When the inverter detects a fault, it stops the operation (trips) or sends out a warning signal. When a trip or warning occurs, the keypad displays the information briefly. If the LCD keypad is used, detailed information is shown on the LCD display. Users can read the warning message at Pr.90. When more than 2 trips occur at roughly the same time, the keypad (basic keypad with 7-segment display) displays the higher priority fault trip information, while the LCD keypad shows the information for the fault trip that occurred first.

The fault conditions can be categorized as follows:

- Level: When the fault is corrected, the trip or warning signal disappears and the fault is not saved in the fault history.
- Latch: When the fault is corrected and a reset input signal is provided, the trip or warning signal disappears.
- Fatal: When the fault is corrected, the fault trip or warning signal disappears only after the user turns off the inverter, waits until the charge indicator light goes off, and turns the inverter on again. If the the inverter is still in a fault condition after powering it on again, please contact the supplier or the LSIS customer service center.

9.1.1 Fault Trips

Protection Functions for Output Current and Input Voltage

Keypad Display	LCD Display	Type	Description
	Over Load	Latch	Displayed when the motor overload trip is activated and the actual load level exceeds the set level. Operates when Pr.20 is set to a value other than 0.
	Under Load	Latch	Displayed when the motor underload trip is activated and the actual load level is less than the set level. Operates when Pr.27 is set to a value other than 0.
	Over Current1	Latch	Displayed when inverter output current exceeds 200% of the rated current.

Keypad Display	LCD Display	Type	Description
	Over Voltage	Latch	Displayed when internal DC circuit voltage exceeds the specified value.
	Low Voltage	Level	Displayed when internal DC circuit voltage is less than the specified value.
	Low Voltage2	Latch	Displayed when internal DC circuit voltage is less than the specified value during inverter operation.
	Ground Trip*	Latch	Displayed when a ground fault trip occurs on the output side of the inverter and causes the current to exceed the specified value. The specified value varies depending on inverter capacity.
	E-Thermal	Latch	Displayed based on inverse time-limit thermal characteristics to prevent motor overheating. Operates when Pr.40 is set to a value other than 0.
	Out Phase Open	Latch	Displayed when a 3-phase inverter output has one or more phases in an open circuit condition. Operates when bit 1 of Pr.05 is set to 1.
	In Phase Open	Latch	Displayed when a 3-phase inverter input has one or more phases in an open circuit condition. Operates only when bit 2 of Pr.05 is set to 1.
	Inverter OLT	Latch	Displayed when the inverter has been protected from overload and resultant overheating, based on inverse time-limit thermal characteristics. Allowable overload rates for the inverter are 150% for 1 min and 200% for 4 sec. Protection is based on inverter rated capacity, and may vary depending on the device's capacity.
	No Motor Trip	Latch	Displayed when the motor is not connected during inverter operation. Operates when Pr.31 is set to 1.

* S100 inverters rated for 4.0kW or less do not support the ground fault trip (GFT) feature.

Therefore, an over current trip (OCT) or over voltage trip (OVT) may occur when there is a low-resistance ground fault.



Protection Functions Using Abnormal Internal Circuit Conditions and External Signals

Keypad Display	LCD Display	Type	Description
	Over Heat	Latch	Displayed when the temperature of the inverter heat sink exceeds the specified value.
	Over Current2	Latch	Displayed when the DC circuit in the inverter detects a specified level of excessive, short circuit current.
	External Trip	Latch	Displayed when an external fault signal is provided by the multi-function terminal. Set one of the multi-function input terminals at In.65-71 to 4 (External Trip) to enable external trip.

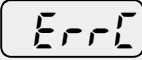
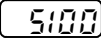

Keypad Display	LCD Display	Type	Description
	BX	Level	Displayed when the inverter output is blocked by a signal provided from the multi-function terminal. Set one of the multi-function input terminals at In.65-71 to 5 (BX) to enable input block function.
	H/W-Diag	Fatal	Displayed when an error is detected in the memory (EEPROM), analog-digital converter output (ADC Off Set), or CPU watchdog (Watch Dog-1, Watch Dog-2). EEP Err: An error in reading/writing parameters due to keypad or memory (EEPROM) fault. ADC Off Set: An error in the current sensing circuit (U/V/W terminal, current sensor, etc.).
	NTC Open	Latch	Displayed when an error is detected in the temperature sensor of the Insulated Gate Bipolar Transistor (IGBT).
	Fan Trip	Latch	Displayed when an error is detected in the cooling fan. Set Pr.79 to 0 to activate fan trip (for models below 22kW capacity).
	Pre-PID Fail	Latch	Displayed when pre-PID is operating with functions set at AP.34–AP.36. A fault trip occurs when a controlled variable (PID feedback) is measured below the set value and the low feedback continues, as it is treated as a load fault.
	Ext-Brake	Latch	Operates when the external brake signal is provided by the multi-function terminal. Occurs when the inverter output starting current remains below the set value at Ad.41. Set either OU.31 or OU.32 to 35 (BR Control).
 	Safety A(B) Err	Level	Displayed when at least one of the two safety input signals is off.

Protection Functions for Communication Options

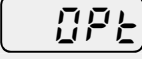
Keypad Display	LCD Display	Type	Description
	Lost Command	Level	Displayed when a frequency or operation command error is detected during inverter operation by controllers other than the keypad (e.g., using a terminal block and a communication mode). Activate by setting Pr.12 to any value other than 0.
 	IO Board Trip	Latch	Displayed when the I/O board or external communication card is not connected to the inverter or there is a bad connection.

Keypad Display	LCD Display	Type	Description
			Displayed when the  error code continues for more than 5 sec. (‘Errc’-> ‘rrc’-> E-rc’-> ‘Er-c’-> ‘Err-’-> ‘-rc’-> ‘Er-’-> ‘----’-> ‘Errc’-> ...)
	ParaWrite Trip	Latch	Displayed when communication fails during parameter writing. Occurs when using an LCD keypad due to a control cable fault or a bad connection.
	Option Trip-1	Latch	Displayed when a communication error is detected between the inverter and the communication board. Occurs when the communication option card is installed.

9.1.2 Warning Messages

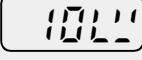
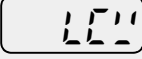
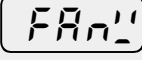
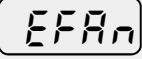
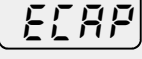
Keypad Display	LCD Display	Description
	Over Load	Displayed when the motor is overloaded. Operates when Pr.17 is set to 1. To operate, select 5. Set the digital output terminal or relay (OU.31 or OU.33) to 5 (Over Load) to receive overload warning output signals.
	Under Load	Displayed when the motor is underloaded. Operates when Pr.25 is set to 1. Set the digital output terminal or relay (OU.31 or OU.33) to 7 (Under Load) to receive underload warning output signals.
	INV Over Load	Displayed when the overload time equivalent to 60% of the inverter overheat protection (inverter IOLT) level, is accumulated. Set the digital output terminal or relay (OU.31 or OU.33) to 6 (IOL) to receive inverter overload warning output signals.
	Lost Command	Lost command warning alarm occurs even with Pr.12 set to 0. The warning alarm occurs based on the condition set at Pr.13- 15. Set the digital output terminal or relay (OU.31 or OU.33) to 13 (Lost Command) to receive lost command warning output signals. If the communication settings and status are not suitable for P2P, a Lost Command alarm occurs.
	Fan Warning	Displayed when an error is detected from the cooling fan while Pr.79 is set to 1. Set the digital output terminal or relay (OU.31 or OU.33) to 8 (Fan Warning) to receive fan warning output signals
	Fan Exchange	An alarm occurs when the value set at PRT-86 is less than the value set at PRT-87. To receive fan exchange output signals, set the digital output terminal or relay (OUT-31 or OUT-33) to 38 (Fan Exchange).
	CAP Exchange	An alarm occurs when the value set at PRT-63 is less than the value set at PRT-62 (the value set at PRT-61 must be 2 (Pre Diag)). To receive CAP exchange signals, set the digital output terminal or relay (OUT-31 or OUT-33) to 36 (CAP Exchange).

Keypad Display	LCD Display	Description
	DB Warn %ED	Displayed when the DB resistor usage rate exceeds the set value. Set the detection level at Pr.66.
	Retry Tr Tune	Tr tune error warning alarm is activated when Dr.9 is set to 4. The warning alarm occurs when the motor's rotor time constant (Tr) is either too low or too high.

9.2 Troubleshooting Fault Trips

When a fault trip or warning occurs due to a protection function, refer to the following table for possible causes and remedies.

Type	Cause	Remedy
Over Load	The load is greater than the motor's rated capacity.	Ensure that the motor and inverter have appropriate capacity ratings.
	The set value for the overload trip level (Pr.21) is too low.	Increase the set value for the overload trip level.
Under Load	There is a motor-load connection problem.	Replace the motor and inverter with models with lower capacity.
	The set value for underload level (Pr.29, Pr.30) is less than the system's minimum load.	Reduce the set value for the underload level.
Over Current ¹	Acc/Dec time is too short, compared to load inertia (GD2).	Increase Acc/Dec time.
	The inverter load is greater than the rated capacity.	Replace the inverter with a model that has increased capacity.
	The inverter supplied an output while the motor was idling.	Operate the inverter after the motor has stopped or use the speed search function (Cn.60).
	The mechanical brake of the motor is operating too fast.	Check the mechanical brake.
Over Voltage	Deceleration time is too short for the load inertia (GD2).	Increase the acceleration time.
	A generative load occurs at the inverter output.	Use the braking unit.
	The input voltage is too high.	Determine if the input voltage is above the specified value.
Low Voltage	The input voltage is too low.	Determine if the input voltage is below the specified value.
	A load greater than the power capacity is connected to the system (e.g., a welder, direct motor connection, etc.)	Increase the power capacity.
	The magnetic contactor connected to the	Replace the magnetic contactor.

Type	Cause	Remedy
	power source has a faulty connection.	
Low Voltage ²	The input voltage has decreased during the operation.	Determine if the input voltage is above the specified value.
	An input phase-loss has occurred.	Check the input wiring.
	The power supply magnetic contactor is faulty.	Replace the magnetic contractor.
Ground Trip	A ground fault has occurred in the inverter output wiring.	Check the output wiring.
	The motor insulation is damaged.	Replace the motor.
E-Thermal	The motor has overheated.	Reduce the load or operation frequency.
	The inverter load is greater than the rated capacity.	Replace the inverter with a model that has increased capacity.
	The set value for electronic thermal protection is too low.	Set an appropriate electronic thermal level.
	The inverter has been operated at low speed for an extended duration.	Replace the motor with a model that supplies extra power to the cooling fan.
Output Phase Open	The magnetic contactor on the output side has a connection fault.	Check the magnetic contactor on the output side.
	The output wiring is faulty.	Check the output wiring.
Input Phase Open	The magnetic contactor on the input side has a connection fault.	Check the magnetic contactor on the input side.
	The input wiring is faulty.	Check the input wiring.
	The DC link capacitor needs to be replaced.	Replace the DC link capacitor. Contact the retailer or the LSIS customer service center.
Inverter OLT	The load is greater than the rated motor capacity.	Replace the motor and inverter with models that have increased capacity.
	The torque boost level is too high.	Reduce the torque boost level.
Over Heat	There is a problem with the cooling system.	Determine if a foreign object is obstructing the air inlet, outlet, or vent.
	The inverter cooling fan has been operated for an extended period.	Replace the cooling fan.
	The ambient temperature is too high.	Keep the ambient temperature below 50°C.
Over Current ²	Output wiring is short-circuited.	Check the output wiring.
	There is a fault with the electronic semiconductor (IGBT).	Do not operate the inverter. Contact the retailer or the LSIS customer service center.
NTC Open	The ambient temperature is too low.	Keep the ambient temperature above -10°C.
	There is a fault with the internal temperature sensor.	Contact the retailer or the LSIS customer service center.
FAN Lock	A foreign object is obstructing the fan's air	Remove the foreign object from the air

Type	Cause	Remedy
	vent.	inlet or outlet.
	The cooling fan needs to be replaced.	Replace the cooling fan.
IP54 FAN Trip	The fan connector is not connected.	Connect the fan connector.
	The fan connector needs to be replaced.	Replace the fan connector.

9.3 Troubleshooting Other Faults

When a fault other than those identified as fault trips or warnings occurs, refer to the following table for possible causes and remedies.

Type	Cause	Remedy
Parameters cannot be set.	The inverter is in operation (driving mode).	Stop the inverter to change to program mode and set the parameter.
	The parameter access is incorrect.	Check the correct parameter access level and set the parameter.
	The password is incorrect.	Check the password, disable the parameter lock and set the parameter.
	Low voltage is detected.	Check the power input to resolve the low voltage and set the parameter.
The motor does not rotate.	The frequency command source is set incorrectly.	Check the frequency command source setting.
	The operation command source is set incorrectly.	Check the operation command source setting.
	Power is not supplied to the terminal R/S/T.	Check the terminal connections R/S/T and U/V/W.
	The charge lamp is turned off.	Turn on the inverter.
	The operation command is off.	Turn on the operation command (RUN).
	The motor is locked.	Unlock the motor or lower the load level.
	The load is too high.	Operate the motor independently.
	An emergency stop signal is input.	Reset the emergency stop signal.
	The wiring for the control circuit terminal is incorrect.	Check the wiring for the control circuit terminal.
	The input option for the frequency command is incorrect.	Check the input option for the frequency command.
	The input voltage or current for the frequency command is incorrect.	Check the input voltage or current for the frequency command.
	The PNP/NPN mode is selected incorrectly.	Check the PNP/NPN mode setting.
The frequency command value is too low.	Check the frequency command and input a value above the minimum	

Type	Cause	Remedy
		frequency.
	The [STOP/RESET] key is pressed.	Check that the stoppage is normal, if so resume operation normally.
	Motor torque is too low.	Change the operation modes (V/F, IM, and Sensorless). If the fault remains, replace the inverter with a model with increased capacity.
The motor rotates in the opposite direction to the command.	The wiring for the motor output cable is incorrect.	Determine if the cable on the output side is wired correctly to the phase (U/V/W) of the motor.
	The signal connection between the control circuit terminal (forward/reverse rotation) of the inverter and the forward/reverse rotation signal on the control panel side is incorrect.	Check the forward/reverse rotation wiring.
The motor only rotates in one direction.	Reverse rotation prevention is selected.	Remove the reverse rotation prevention.
	The reverse rotation signal is not provided, even when a 3-wire sequence is selected.	Check the input signal associated with the 3-wire operation and adjust as necessary.
The motor is overheating.	The load is too heavy.	Reduce the load.
		Increase the Acc/Dec time.
		Check the motor parameters and set the correct values.
		Replace the motor and the inverter with models with appropriate capacity for the load.
	The ambient temperature of the motor is too high.	Lower the ambient temperature of the motor.
The phase-to-phase voltage of the motor is insufficient.		Use a motor that can withstand phase-to-phase voltages surges greater than the maximum surge voltage.
		Only use motors suitable for applications with inverters.
		Connect the AC reactor to the inverter output (set the carrier frequency to 2 kHz).
	The motor fan has stopped or the fan is obstructed with debris.	Check the motor fan and remove any foreign objects.
The motor stops during acceleration or when connected to load.	The load is too high.	Reduce the load.
		Replace the motor and the inverter with models with capacity appropriate for the load.

Type	Cause	Remedy
The motor does not accelerate. /The acceleration time is too long.	The frequency command value is low.	Set an appropriate value.
	The load is too high.	Reduce the load and increase the acceleration time. Check the mechanical brake status.
	The acceleration time is too long.	Change the acceleration time.
	The combined values of the motor properties and the inverter parameter are incorrect.	Change the motor related parameters.
	The stall prevention level during acceleration is low.	Change the stall prevention level.
	The stall prevention level during operation is low.	Change the stall prevention level.
	Starting torque is insufficient.	Change to vector control operation mode. If the fault is still not corrected, replace the inverter with a model with increased capacity.
Motor speed varies during operation.	There is a high variance in load.	Replace the motor and inverter with models with increased capacity.
	The input voltage varies.	Reduce input voltage variation.
	Motor speed variations occur at a specific frequency.	Adjust the output frequency to avoid a resonance area.
The motor rotation is different from the setting.	The V/F pattern is set incorrectly.	Set a V/F pattern that is suitable for the motor specification.
The motor deceleration time is too long even with Dynamic Braking (DB) resistor connected.	The deceleration time is set too long.	Change the setting accordingly.
	The motor torque is insufficient.	If motor parameters are normal, it is likely to be a motor capacity fault. Replace the motor with a model with increased capacity.
	The load is higher than the internal torque limit determined by the rated current of the inverter.	Replace the inverter with a model with increased capacity.
Operation is difficult in underload applications.	The carrier frequency is too high.	Reduce the carrier frequency.
	Over-excitation has occurred due to an inaccurate V/F setting at low speed.	Reduce the torque boost value to avoid over-excitation.
While the inverter is in operation, a control unit malfunctions or noise occurs.	Noise occurs due to switching inside the inverter.	Change the carrier frequency to the minimum value.
		Install a micro surge filter in the inverter output.

Type	Cause	Remedy
When the inverter is operating, the earth leakage breaker is activated.	An earth leakage breaker will interrupt the supply if current flows to ground during inverter operation.	Connect the inverter to a ground terminal.
		Check that the ground resistance is less than 100Ω for 200V inverters and less than 10Ω for 400V inverters.
		Check the capacity of the earth leakage breaker and make the appropriate connection, based on the rated current of the inverter.
		Lower the carrier frequency.
		Make the cable length between the inverter and the motor as short as possible.
The motor vibrates severely and does not rotate normally.	Phase-to-phase voltage of 3-phase power source is not balanced.	Check the input voltage and balance the voltage.
		Check and test the motor's insulation.
The motor makes humming, or loud noises.	Resonance occurs between the motor's natural frequency and the carrier frequency.	Slightly increase or decrease the carrier frequency.
	Resonance occurs between the motor's natural frequency and the inverter's output frequency.	Slightly increase or decrease the carrier frequency. Use the frequency jump function to avoid the frequency band where resonance occurs.
The motor vibrates/hunts.	The frequency input command is an external, analog command.	In situations of noise inflow on the analog input side that results in command interference, change the input filter time constant (In.07).
	The wiring length between the inverter and the motor is too long.	Ensure that the total cable length between the inverter and the motor is less than 200m (50m for motors rated 3.7 kW or lower).
The motor does not come to a complete stop when the inverter output stops.	It is difficult to decelerate sufficiently, because DC braking is not operating normally.	Adjust the DC braking parameter.
		Increase the set value for the DC braking current.
		Increase the set value for the DC braking stopping time.
The output frequency does	The frequency reference is within the jump frequency range.	Set the frequency reference higher than the jump frequency range.

Type	Cause	Remedy
not increase to the frequency reference.	The frequency reference is exceeding the upper limit of the frequency command.	Set the upper limit of the frequency command higher than the frequency reference.
	Because the load is too heavy, the stall prevention function is working.	Replace the inverter with a model with increased capacity.
The cooling fan does not rotate.	The control parameter for the cooling fan is set incorrectly.	Check the control parameter setting for the cooling fan.

10 Maintenance

This chapter explains how to replace the cooling fan, the regular inspections to complete, and how to store and dispose of the product. An inverter is vulnerable to environmental conditions and faults also occur due to component wear and tear. To prevent breakdowns, please follow the maintenance recommendations in this section.

Caution

- Before you inspect the product, read all safety instructions contained in this manual.
- Before you clean the product, ensure that the power is off.
- Clean the inverter with a dry cloth. Cleaning with wet cloths, water, solvents, or detergents may result in electric shock or damage to the product.

10.1 Regular Inspection Lists

10.1.1 Daily Inspections

Inspection area	Inspection item	Inspection details	Inspection method	Judgment standard	Inspection equipment
All	Ambient environment	Is the ambient temperature and humidity within the design range, and is there any dust or foreign objects present?	Refer to 1.3 Installation Considerations on page 5 .	No icing (ambient temperature: -10 - +40) and no condensation (ambient humidity below 50%)	Thermometer, hygrometer, recorder
	Inverter	Is there any abnormal vibration or noise?	Visual inspection	No abnormality	
	Power voltage	Are the input and output voltages normal?	Measure voltages between R/ S/ T-phases in. the inverter terminal block.	Refer to 11.1 Input and Output Specification on page 341 .	Digital multimeter tester

Inspection area	Inspection item	Inspection details	Inspection method	Judgment standard	Inspection equipment
Input/Output circuit	Smoothing capacitor	Is there any leakage from the inside?	Visual inspection	No abnormality	-
		Is the capacitor swollen?			
Cooling system	Cooling fan	Is there any abnormal vibration or noise?	Turn off the system and check operation by rotating the fan manually.	Fan rotates smoothly	-
Display	Measuring device	Is the display value normal?	Check the display value on the panel.	Check and manage specified values.	Voltmeter, ammeter, etc.
Motor	All	Is there any abnormal vibration or noise?	Visual inspection	No abnormality	-
		Is there any abnormal smell?	Check for overheating or damage.		

10.1.2 Annual Inspections

Inspection area	Inspection item	Inspection details	Inspection method	Judgment standard	Inspection equipment
Input/Output circuit	All	Megger test (between input/output terminals and and earth terminal)	Disconnect inverter and short R/S/T/U/V/W terminals, and then measure from each terminal to the ground terminal using a Megger.	Must be above 5 MΩ	DC 500 V Megger
		Is there anything loose in the device?	Tighten up all screws.	No abnormality	
		Is there any evidence of	Visual inspection		

Inspection area	Inspection item	Inspection details	Inspection method	Judgment standard	Inspection equipment
		parts overheating?			
	Cable connections	Are there any corroded cables?	Visual inspection	No abnormality	-
		Is there any damage to cable insulation?			
	Terminal block	Is there any damage?	Visual inspection	No abnormality	-
	Smoothing condenser	Measure electrostatic capacity.	Measure with capacity meter.	Rated capacity over 85%	Capacity meter
	Relay	Is there any chattering noise during operation?	Visual inspection	No abnormality	-
		Is there any damage to the contacts?	Visual inspection		
	Braking resistor	Is there any damage from resistance?	Visual inspection	No abnormality	Digital multimeter / anaog tester
		Check for disconnection.	Disconnect one side and measure with a tester.	Must be within $\pm 10\%$ of the rated value of the resistor.	
	Control circuit Protection circuit	Operation check	Check for output voltage imbalance while the inverter is in operation.	Measure voltage between the inverter output terminal U/V/W.	Balance the voltage between phases: within 4V for 200V series and within 8V for 400V series.
Is there an error in the display circuit after the sequence			Test the inverter ouput protection in both short and	The circuit must work according to the sequence.	

Inspection area	Inspection item	Inspection details	Inspection method	Judgment standard	Inspection equipment
		protection test?	open circuit conditions.		
Cooling system	Cooling fan	Are any of the fan parts loose?	Check all connected parts and tighten all screws.	No abnormality	-
Display	Display device	Is the display value normal?	Check the command value on the display device.	Specified and managed values must match.	Voltmeter, Ammeter, etc.

10.1.3 Bi-annual Inspections

Inspection area	Inspection item	Inspection details	Inspection method	Judgment standard	Inspection equipment
Motor	Insulation resistance	Megger test (between the input, output and earth terminals).	Disconnect the cables for terminals U/V/W and test the wiring.	Must be above 5 MΩ	DC 500 V Megger

Caution

Do not run an insulation resistance test (Megger) on the control circuit as it may result in damage to the product.

10.2 Storage and Disposal

10.2.1 Storage

If you are not using the product for an extended period, store it in the following way:

- Store the product in the same environmental conditions as specified for operation (refer to [1.3 Installation Considerations](#) on page 5).
- When storing the product for a period longer than 3 months, store it between 10°C and 30°C,

to prevent depletion of the electrolytic capacitor.

- Do not expose the inverter to snow, rain, fog, or dust.
- Package the inverter in a way that prevents contact with moisture. Keep the moisture level below 70% in the package by including a desiccant, such as silica gel.

10.2.2 Disposal

When disposing of the product, categorize it as general industrial waste. Recyclable materials are included in the product, so recycle them whenever possible. The packing materials and all metal parts can be recycled. Although plastic can also be recycled, it can be incinerated under controlled conditions in some regions.

Caution

If the inverter has not been operated for a long time, capacitors lose their charging characteristics and are depleted. To prevent depletion, turn on the product once a year and allow the device to operate for 30-60 min. Run the device under no-load conditions.

11 Technical Specification

11.1 Input and Output Specification

Single Phase 200V (0.4-2.2 kW)

Model □□□□S100-1□□□			0004	0008	0015	0022	
Applied motor	Heavy load	HP	0.5	1.0	2.0	3.0	
		kW	0.4	0.75	1.5	2.2	
	Normal load	HP	1.0	2.0	3.0	5.0	
		kW	0.75	1.5	2.2	3.7	
Rated output	Rated capacity (kVA)	Heavy load	1.0	1.9	3.0	4.2	
		Normal load	1.2	2.3	3.8	4.6	
	Rated current (A)	Heavy load	2.5	5.0	8.0	11.0	
		Normal load	3.1	6.0	9.6	12.0	
	Output frequency		0-400 Hz (IM Sensorless: 0-120 Hz)				
	Output voltage (V)		3-phase 200-240 V				
Rated input	Working voltage (V)		Single phase 200-240 V AC (-15% to +10%)				
	Input frequency		50-60 Hz (±5%)				
	Rated current (A)	Heavy load	4.4	9.3	15.6	21.7	
		Normal load	5.8	11.7	19.7	24.0	
Weight (lb /kg) (Built-in EMC filter)			2/0.9 (2.5/1.14)	2.86/1.3 (3.9/1.76)	3.3/1.5 (3.9/1.76)	4.4/2.0 (4.9/2.22)	

- The standard motor capacity is based on a standard 4-pole motor.
- The standard used for 200 V inverters is based on a 220 V supply voltage, and for 400V inverters is based on a 440 V supply voltage.
- The rated output current is limited based on the carrier frequency set at Cn.04.

3 Phase 200V (0.4-4 kW)

Model □□□□S100-2□□□			0004	0008	0015	0022	0037	0040	
Applied motor	Heavy load	HP	0.5	1.0	2.0	3.0	5.0	5.4	
		kW	0.4	0.75	1.5	2.2	3.7	4.0	
	Normal load	HP	1.0	2.0	3.0	5.0	5.4	7.5	
		kW	0.75	1.5	2.2	3.7	4.0	5.5	
Rated output	Rated capacity (kVA)	Heavy load	1.0	1.9	3.0	4.2	6.1	6.5	
		Normal load	1.2	2.3	3.8	4.6	6.9	6.9	
	Rated current (A)	Heavy load	2.5	5.0	8.0	11.0	16.0	17.0	
		Normal load	3.1	6.0	9.6	12.0	18.0	18.0	
	Output frequency		0-400 Hz (IM Sensorless: 0-120 Hz)						
	Output voltage (V)		3-phase 200-240 V						
Rated input	Working voltage (V)		3-phase 200-240 VAC (-15% to +10%)						
	Input frequency		50-60 Hz (±5%)						
	Rated current (A)	Heavy load	2.2	4.9	8.4	11.8	17.5	18.5	
		Normal load	3.0	6.3	10.8	13.1	19.4	19.4	
Weight (lb /kg)			2/0.9	2/0.9	2.86/1.3	3.3/1.5	4.4/2.0	4.4/2.0	

- The standard motor capacity is based on a standard 4-pole motor.
- The standard used for 200 V inverters is based on a 220 V supply voltage, and for 400V inverters is based on a 440 V supply voltage.
- The rated output current is limited based on the carrier frequency set at Cn.04.

3 Phase 200V (5.5-15 kW)

Model □□□□S100-2□□□			0055	0075	0110	0150
Applied motor	Heavy load	HP	7.5	10	15	20
		kW	5.5	7.5	11	15
	Normal load	HP	10	15	20	25
		kW	7.5	11	15	18.5
Rated output	Rated capacity (kVA)	Heavy load	9.1	12.2	17.5	22.9
		Normal load	11.4	15.2	21.3	26.3
	Rated current (A)	Heavy load	24.0	32.0	46.0	60.0
		Normal load	30.0	40.0	56.0	69.0
	Output frequency		0-400 Hz (IM Sensorless : 0-120 Hz)			
	Output voltage (V)		3 phase 200-240V			
Rated input	Working voltage (V)		3 phase 200-240VAC (-15% to +10%)			
	Input frequency		50-60 Hz (±5%)			
	Rated current (A)	Heavy load	25.8	34.9	50.8	66.7
Normal load		32.7	44.2	62.3	77.2	
Weight (lb /kg)			7.3/3.3	7.3/3.3	10/4.6	16/7.1

- The standard motor capacity is based on a standard 4-pole motor
- The standard used for 200 V inverters is based on a 220 V supply voltage, and for 400V inverters is based on a 440 V supply voltage.
- The rated output current is limited based on the carrier frequency set at Cn.04.

3-Phase 400V (0.4-4 kW)

Model □□□□S100-4□□□			0004	0008	0015	0022	0037	0040	
Applied motor	Heavy load	HP	0.5	1.0	2.0	3.0	5.0	5.4	
		kW	0.4	0.75	1.5	2.2	3.7	4.0	
	Normal load	HP	1.0	2.0	3.0	5.0	5.4	7.5	
		kW	0.75	1.5	2.2	3.7	4.0	5.5	
Rated output	Rated capacity (kVA)	Heavy load	1.0	1.9	3.0	4.2	6.1	6.5	
		Normal load	1.5	2.4	3.9	5.3	7.6	7.6	
	Rated current (A)	Heavy load	1.3	2.5	4.0	5.5	8.0	9.0	
		Normal load	2.0	3.1	5.1	6.9	10.0	10.0	
	Output frequency		0-400 Hz (IM Sensorless: 0-120 Hz)						
	Output voltage (V)		3-phase 380-480V						
Rated input	Working voltage (V)		3-phase 380-480VAC (-15% to +10%)						
	Input frequency		50-60 Hz (±5%)						
	Rated current (A)	Heavy load	1.1	2.4	4.2	5.9	8.7	9.8	
		Normal load	2.0	3.3	5.5	7.5	10.8	10.8	
Weight (lb /kg) (Built-in EMC filter)			2/0.9 (2.6/1.18)	2/0.9 (2.6/1.18)	2.86/1.3 (3.9/1.77)	3.3/1.5 (4/1.80)	4.4/2.0 (4.9/2.23)	4.4/2.0 (4.9/2.23)	

- The standard motor capacity is based on a standard 4-pole motor.
- The standard used for 200 V inverters is based on a 220 V supply voltage, and for 400V inverters is based on a 440 V supply voltage.
- The rated output current is limited based on the carrier frequency set at Cn.04.

3-Phase 400V (5.5-22 kW)

Model □□□□S100-4□□□			0055	0075	0110	0150	0185	0220	
Applied motor	Heavy load	HP	7.5	10	15	20	25	30	
		kW	5.5	7.5	11	15	18.5	22	
	Normal load	HP	10	15	20	25	30	40	
		kW	7.5	11	15	18.5	22	30	
Rated output	Rated capacity (kVA)	Heavy load	9.1	12.2	18.3	22.9	29.7	34.3	
		Normal load	12.2	17.5	22.9	29.0	33.5	44.2	
	Rated current (A)	Heavy load	12.0	16.0	24.0	30.0	39.0	45.0	
		Normal load	16.0	23.0	30.0	38.0	44.0	58.0	
	Output frequency		0-400 Hz (IM Sensorless: 0-120 Hz)						
	Output voltage (V)		3-phase 380-480V						
Rated input	Working voltage (V)		3-phase 380-480VAC (-15% to +10%)						
	Input frequency		50-60 Hz (±5%)						
	Rated current (A)	Heavy load	12.9	17.5	26.5	33.4	43.6	50.7	
		Normal load	17.5	25.4	33.4	42.5	49.5	65.7	
Weight (lb /kg)			7.3/3.3	7.5/3.4	10.1/4.6	10.5/4.8	16.5/7.5	16.5/7.5	

- The standard motor capacity is based on a standard 4-pole motor.
- The standard used for 200 V inverters is based on a 220 V supply voltage, and for 400V inverters is based on a 440 V supply voltage.
- The rated output current is limited, based on the carrier frequency set at Cn.04.

11.2 Product Specification Details

Items		Description
Control	Control method	V/F control, slip compensation, sensorless vector
	Frequency settings power resolution	Digital command: 0.01 Hz Analog command: 0.06 Hz (60 Hz standard)
	Frequency accuracy	1% of maximum output frequency
	V/F pattern	Linear, square reduction, user V/F
	Overload capacity	Heavy load rated current: 150% 1 min, normal load rated current: 120% 1 min
	Torque boost	Manual torque boost, automatic torque boost
Operation	Operation type	Select key pad, terminal strip, or communication operation
	Frequency settings	Analog type: -10~10V, 0~10V, 4~20mA Digital type: key pad, pulse train input
	Operation function	<ul style="list-style-type: none"> • PID control • 3-wire operation • Frequency limit • Second function • Anti-forward and reverse direction rotation • Commercial transition • Speed search • Power braking • Leakage reduction <ul style="list-style-type: none"> • Up-down operation • DC braking • Frequency jump • Slip compensation • Automatic restart • Automatic tuning • Energy buffering • Flux braking • Fire Mode
	Input	Multi function terminal (7EA) P1-P7
<ul style="list-style-type: none"> • Forward direction operation • Reset • Emergency stop • Multi step speed frequency-high/med/low • DC braking during stop • Frequency increase • 3-wire • Local/remote operation mode transition • Select acc/dec/stop <ul style="list-style-type: none"> • Reverse direction operation • External trip • Jog operation • Multi step acc/dec-high/med/low • Second motor selection • Frequency reduction • Fix analog command frequency • Transition from PID to general operation 		
	Pulse train	0-32 kHz, Low Level: 0-0.8V, High Level: 3.5-12V

Items			Description	
	Output	Multi function open collector terminal	Fault output and inverter operation status output	Less than DC 24V, 50mA
		Multi function relay terminal		Less than (N.O., N.C.) AC250V 1A, Less than DC 30V, 1A
	Analog output	0-12Vdc (0-24mA): Select frequency, output current, output voltage, DC terminal voltage and others		
	Pulse train	Maximum 32 kHz, 10-12V		
Protection function	Trip	<ul style="list-style-type: none"> • Over current trip • External signal trip • ARM short circuit current trip • Over heat trip • Input imaging trip • Ground trip • Motor over heat trip • I/O board link trip • No motor trip • Parameter writing trip • Emergency stop trip • Command loss trip • External memory error • CPU watchdog trip • Motor normal load trip <ul style="list-style-type: none"> • Over voltage trip • Temperature sensor trip • Inverter over heat • Option trip • Output imaging trip • Inverter overload trip • Fan trip • Pre-PID operation failure • External break trip • Low voltage trip during operation • Low voltage trip • Safety A(B) trip • Analog input error • Motor overload trip 		
	Alarm	Command loss trip alarm, overload alarm, normal load alarm, inverter overload alarm, fan operation alarm, resistance braking rate alarm, number of corrections on rotor tuning error		
	Instantaneous blackout	Heavy load less than 15 ms (normal load less than 8 ms): continue operation (must be within the rated input voltage and rated output range) Heavy load more than 15 ms (normal load more than 8 ms): auto restart operation		
Structure/working environment	Cooling type	Forced fan cooling structure Forced cooling type: 0.4-15 kW 200V/0.4-22 kW 400V (excluding some models)		
	Protection structure	IP 20 , UL Open Type (UL Enclosed Type 1 is satisfied by conduit installation option.)		
	Ambient temperature	Heavy load: -10-50°C (14-122°F), normal load: -10-40°C (14-		

Items	Description
	104°F) No ice or frost should be present. Working under normal load at 50°C (122°F), it is recommended that less than 80% load is applied.
Ambient humidity	Relative humidity less than 90% RH (to avoid condensation forming)
Storage temperature.	-20°C-65°C (-4-149°F)
Surrounding environment	Prevent contact with corrosive gases, inflammable gases, oil stains, dust, and other pollutants (Pollution Degree 2 Environment).
Operation altitude/oscillation	No higher than 3280ft (1,000m). Less than 9.8m/sec ² (1G).
Pressure	70-106 kPa

11.3 External Dimensions (IP 20 Type)

0.4 kW (Single Phase), 0.4-0.8 kW (3-Phase)

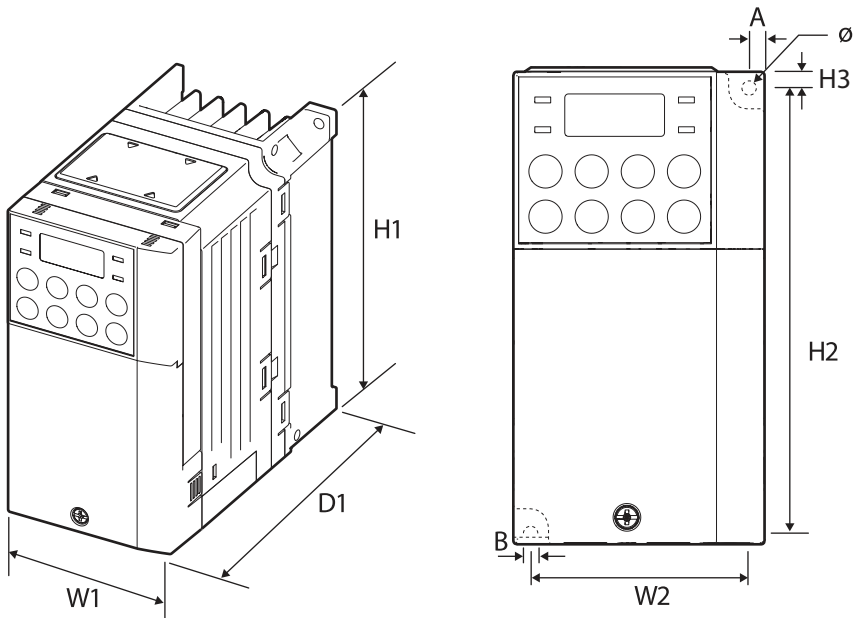

0.8kW~1.5kW(Single Phase 200V), 1.5kW~2.2kW(3-Phase 400V) EMC filter Type

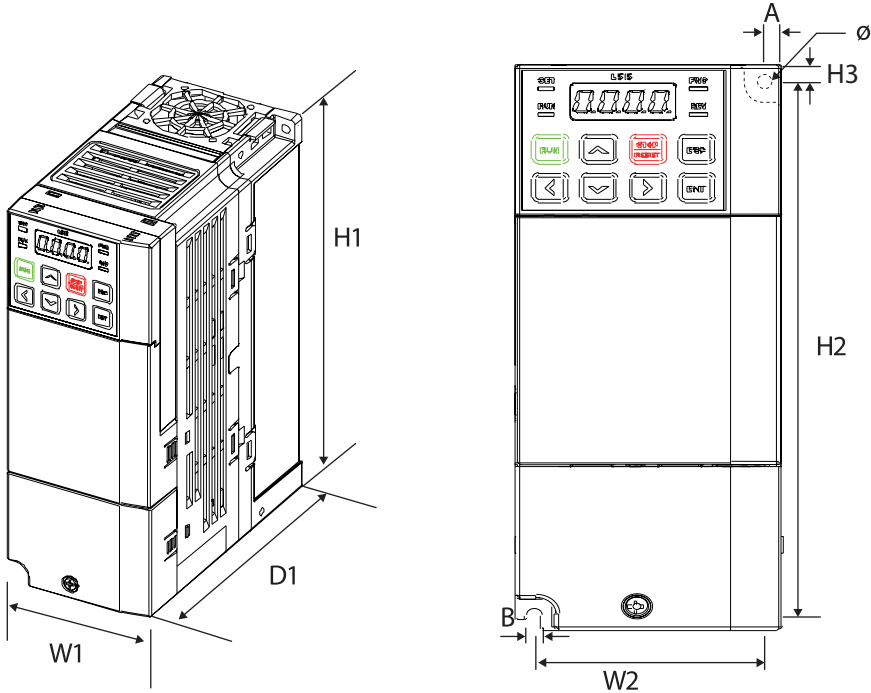

Items	W1	W2	H1	H2	H3	D1	A	B	Φ
0004S100-1, 0008S100-2, 0008S100-4	68 (2.68)	61.1 (2.41)	128 (5.04)	119 (4.69)	5 (0.20)	128 (5.04)	3.5 (0.14)	4 (0.16)	4 (0.16)
0004S100-2, 0004S100-4	68 (2.68)	61.1 (2.41)	128 (5.04)	119 (4.69)	5 (0.20)	123 (4.84)	3.5 (0.14)	4 (0.16)	4.2 (0.17)
004S100-1, 004S100-4, 008S100-4 EMC Type	68 (2.68)	63.5 (2.50)	180 (7.09)	170.5 (6.71)	5 (0.20)	130 (5.12)	4.5 (0.18)	4.5 (0.18)	4.2 (0.17)

Units: mm (inches)

0.8-1.5 kW (Single Phase), 1.5-2.2 kW(3-Phase)

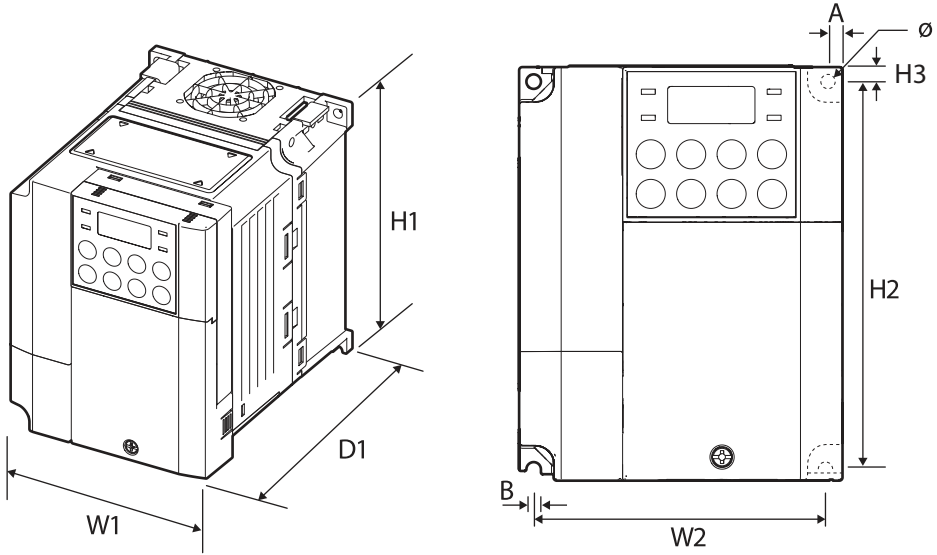

0.8kW~1.5kW(Single Phase 200V), 1.5kW~2.2kW(3-Phase 400V) EMC filter Type

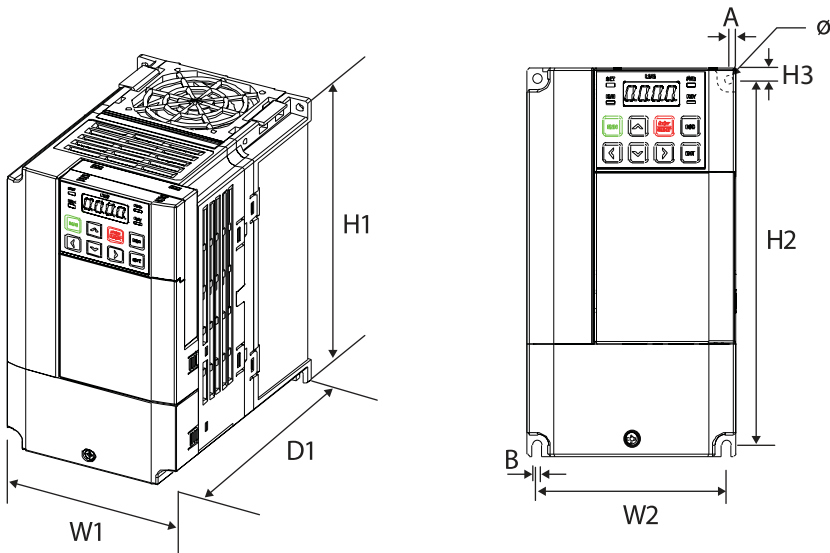

Items	W1	W2	H1	H2	H3	D1	A	B	Φ
0008S100-1, 0015S100-2, 0015S100-4	100 (3.94)	91 (3.58)	128 (5.04)	120 (4.72)	4.5 (0.18)	130 (5.12)	4.5 (0.18)	4.5 (0.18)	4.5 (0.18)

Items	W1	W2	H1	H2	H3	D1	A	B	Φ
0015S100-1, 0022S100-2, 0022S100-4	100 (3.94)	91 (3.58)	128 (5.04)	120 (4.72)	4.5 (0.18)	145 (5.71)	4.5 (0.18)	4.5 (0.18)	4.5 (0.18)
0008S100-1, 0015S100-1, 0015S100-4, 0022S100-4 EMCType	100 (3.94)	91 (3.58)	180 (7.09)	170 (6.69)	5 (0.20)	140 (5.51)	4.5 (0.18)	4.5 (0.18)	4.2 (0.17)

Units: mm (inches)

2.2 kW (Single Phase), 3.7-4.0 kW (3 Phase)

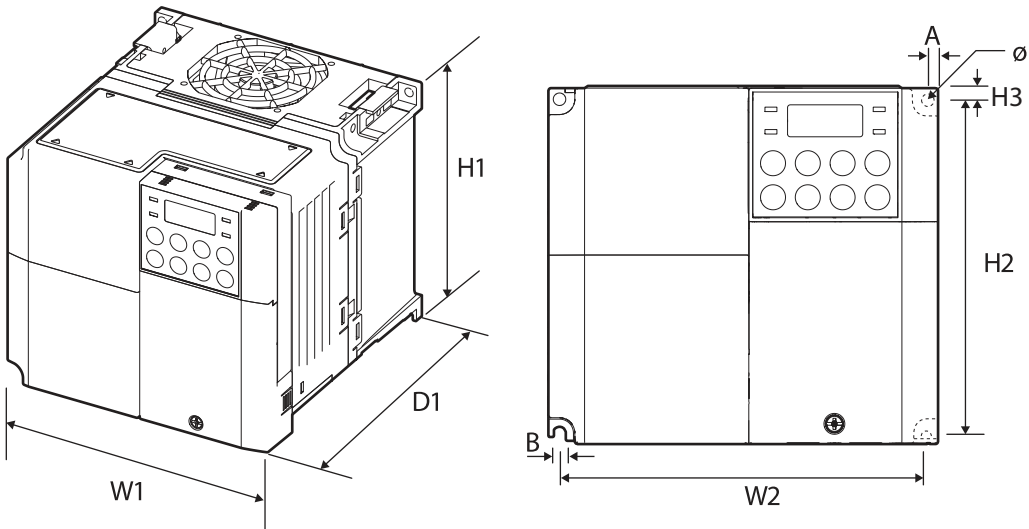

2.2kW(Single Phase 200V), 3.7~4.0kW(3-Phase 400V) EMC filter Type

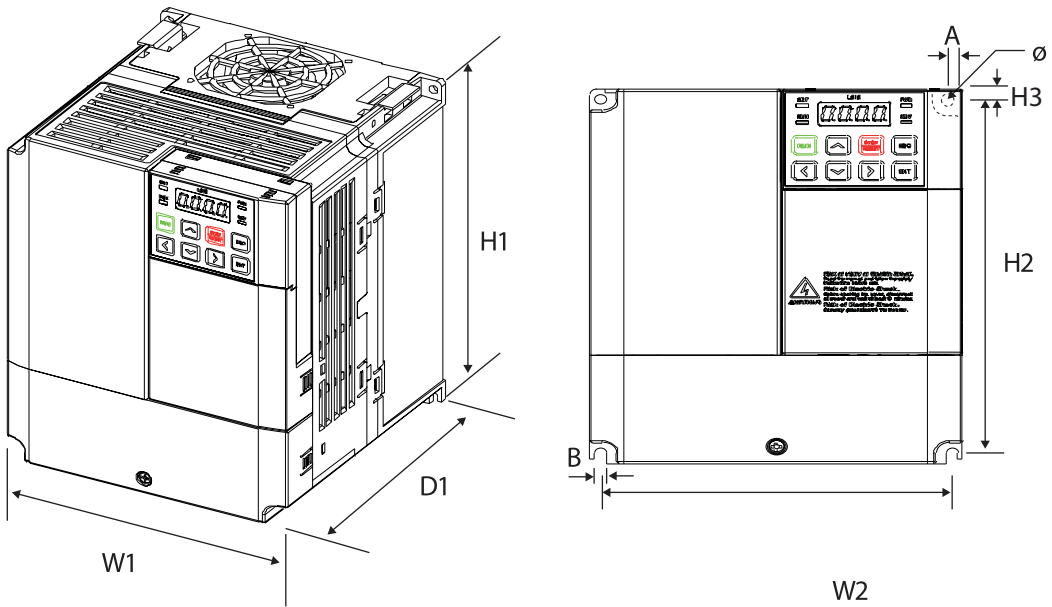

Items	W1	W2	H1	H2	H3	D1	A	B	Φ
0022S100-1 0037S100-2 0040S100-2 0037S100-4 0040S100-4	140 (5.51)	132.2 (5.20)	128 (5.04)	120.7 (4.75)	3.7 (0.15)	145 (5.71)	3.9 (0.15)	4.4 (0.17)	4.5 (0.18)
0022S100-1, 0037S100-4, 0040S100-4 EMCType	140 (5.51)	132 (5.20)	180 (7.09)	170 (6.69)	5 (0.20)	140 (5.51)	4 (0.16)	4 (0.16)	4.2 (0.17)

Units: mm (inches)

5.5-22 kW (3-Phase)

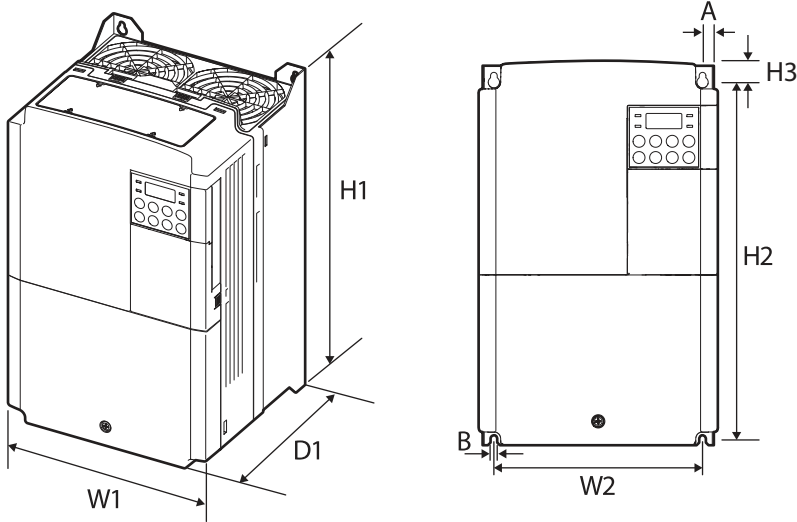

Items		W1	W2	H1	H2	H3	D1	A	B	Ø
3-phase 200V	0055S100-2	160	137	232	216.5	10.5	140	5	5	-
	0075S100-2	(6.30)	(5.39)	(9.13)	(8.52)	(0.41)	(5.51)	(0.20)	(0.20)	-
	0110S100-2	180	157	290	273.7	11.3	163	5	5	-
	0150S100-2	(7.09)	(6.18)	(11.4)	(10.8)	(0.44)	(6.42)	(0.20)	(0.20)	-
3-phase 400V	0150S100-2	220	193.8	350	331	13	187	6	6	-
	0055S100-4	(8.66)	(7.63)	(13.8)	(13.0)	(0.51)	(7.36)	(0.24)	(0.24)	-
	0075S100-4	160	137	232	216.5	10.5	140	5	5	-
	0110S100-4	(6.30)	(5.39)	(9.13)	(8.52)	(0.41)	(5.51)	(0.20)	(0.20)	-
	0150S100-4	180	157	290	273.7	11.3	163	5	5	-
	0185S100-4	(7.09)	(6.18)	(11.4)	(10.8)	(0.44)	(6.42)	(0.20)	(0.20)	-
0220S100-4	220	193.8	350	331	13	187	6	6	-	
		(8.66)	(7.63)	(13.8)	(13.0)	(0.51)	(7.36)	(0.24)	(0.24)	-

Units: mm (inches)

11.4 Peripheral Devices

Compatible Circuit Breaker, Leakage Breaker and Magnetic Contactor Models (manufactured by LSIS)

Product (kW)		Circuit Breaker				Leakage Breaker		Magnetic Contactor			
		Model	Current (A)	Model	Current (A)	Model	Current (A)	Model	Current (A)		
Single phase 200V	0.4	ABS33c	5	UTE100	15	EBS33c	5	MC-6a	9		
	0.75		10				10	MC-9a, MC-9B	11		
	1.5		15				15	MC-18a, MC-18B	18		
	2.2		20				20	MC-22b	22		
3-phase 200V	0.4	ABS33c	5	UTE100	15	EBS33c	5	MC-6a	9		
	0.75		10				10	MC-9a, MC-9b	11		
	1.5		15				15	MC-18a, MC-18b	18		
	2.2		20				20	MC-22b	22		
	3.7		30				30	30	30	MC-32a	32
	4										
	5.5	ABS53c	50	50	EBS53c	50	MC-50a	55			
	7.5	ABS63c	60	60	EBS63c	60	MC-65a	65			
	11	ABS103c	100	90	EBS103c	100	MC-85a	85			
	15		125	UTS150		125	125	MC-130a	130		
3-phase 400V	0.4	ABS33c	3	UTE100	15	EBS33c	5	MC-6a	7		
	0.75		5					MC-6a			
	1.5		10				10	10	10	MC-9a, MC-9b	9
	2.2									MC-12a, MC-12b	
	3.7		15				15	15	15	MC-18a, MC-18b	18
	4		20								
	5.5		30				30	30	30	MC-22b	22
	7.5									MC-32a	
	11	ABS53c	50	50	EBS53c	50	MC-50a	50			
	15	ABS63c	60	60	EBS63c	60	MC-65a	65			
	18.5	ABS103c	75	80	EBS103c	75	MC-75a	75			
22	100		90	100		100	MC-85a	85			

11.5 Fuse and Reactor Specifications

Product (kW)		AC Input Fuse		AC Reactor		DC Reactor	
		Current (A)	Voltage (V)	Inductance (mH)	Current(A)	Inductance (mH)	Current (A)
Single phase 200V	0.4	10	600	1.20	10	4	8.67
	0.75						
	1.5	15		0.88	14	3	13.05
	2.2	20		0.56	20	1.3	18.45
3-phase 200V	0.4	10		1.20	10	4	8.67
	0.75						
	1.5	15		0.88	14	3	13.05
	2.2	20		0.56	20	1.33	18.45
	3.7	32		0.39	30		26.35
	4	50					
	5.5	50		0.30	34	1.60	32
	7.5	63		0.22	45	1.25	43
	11	80	0.16	64	0.95	61	
	15	100	0.13	79	0.70	75	
3-phase 400V	0.4	10	4.81	4.8	16	4.27	
	0.75						
	1.5		3.23	7.5	12	6.41	
	2.2	15	2.34	10	8	8.9	
	3.7	20	1.22	15	5.4	13.2	
	4	32					
	5.5		1.12	19	3.20	17	
	7.5	35	0.78	27	2.50	25	
	11	50	0.59	35	1.90	32	
	15	63	0.46	44	1.40	41	
	18.5	70	0.40	52	1.00	49	
	22	100	0.30	68	0.70	64	

⚠ Caution

Only use Class H or RK5, UL listed input fuses and UL listed circuit breakers. See the table above for the voltage and current ratings for fuses and circuit breakers.

⚠ Attention

Utiliser UNIQUEMENT des fusibles d'entrée homologués de Classe H ou RK5 UL et des disjoncteurs UL. Se reporter au tableau ci-dessus pour la tension et le courant nominal des fusibles et des disjoncteurs.

11.6 Terminal Screw Specification

Input/Output Terminal Screw Specification

Product (kW)		Terminal Screw Size	Screw Torque (Kgf·cm/Nm)
Single phase 200V	0.4	M3.5	2.1-6.1/0.2-0.6
	0.75		
	1.5		
	2.2	M4	
3-phase 200V	0.4	M3.5	4.0-10.2/0.4-1.0
	0.75		
	1.5		
	2.2		
	3.7	M4	
	4		
	5.5		
	7.5	M5	
	11		
	15		
3-phase 400V	0.4	M3.5	4.0-10.2/0.4-1.0
	0.75		
	1.5		
	2.2		
	3.7	M4	
	4		
	5.5		
	7.5	M5	
	11		
	15		
	18.5		
22			

Control Circuit Terminal Screw Specification

Terminal	Terminal Screw Size	Screw Torque (Kgf·cm/Nm)
P1-P7/ CM/VR/V1/I2/AO/Q1/EG/24/TI /TO/ SA,SB,SC/S+,S-,SG	M2	2.2-2.5/0.22-0.25
A1/B1/C1	M2.6	4.0/0.4

* Standard I/O doesn't support P6/P7/TI/TO terminal. Refer to Step 4 Control Terminal Wiring on page 27.

⚠ Caution

Apply the rated torque when tightening terminal screws. Loose screws may cause short circuits and malfunctions. Overtightening terminal screws may damage the terminals and cause short circuits and malfunctions. Use copper conductors only, rated at 600V, 75°C for power terminal wiring, and rated at 300V, 75°C for control terminal wiring.

ⓘ Attention

Appliquer des couples de marche aux vis des bornes. Des vis desserrées peuvent provoquer des courts-circuits et des dysfonctionnements. Ne pas trop serrer la vis, car cela risque d'endommager les bornes et de provoquer des courts-circuits et des dysfonctionnements. Utiliser uniquement des fils de cuivre avec une valeur nominale de 600 V, 75 °C pour le câblage de la borne d'alimentation, et une valeur nominale de 300 V, 75 °C pour le câblage de la borne de commande.

11.7 Braking Resistor Specification

Product (kW)		Resistance (Ω)	Rated Capacity (W)
Single phase 200V	0.4	300	100
	0.75	150	150
	1.5	60	300
	2.2	50	400
3-phase 200V	0.4	300	100
	0.75	150	150
	1.5	60	300
	2.2	50	400
	3.7	33	600
	4	33	600
	5.5	20	800
	7.5	15	1,200
	11	10	2,400
15	8	2,400	
3-phase 400V	0.4	1,200	100
	0.75	600	150
	1.5	300	300
	2.2	200	400
	3.7	130	600
	4	130	600
	5.5	85	1,000
	7.5	60	1,200
	11	40	2,000
	15	30	2,400
	18.5	20	3,600
	22	20	3,600

- The standard for braking torque is 150% and the working rate (%ED) is 5%. If the working rate is 10%, the rated capacity for braking resistance must be calculated at twice the standard.

11.8 Continuous Rated Current Derating

Derating by Carrier Frequency

The continuous rated current of the inverter is limited based on the carrier frequency. Refer to the following graph.

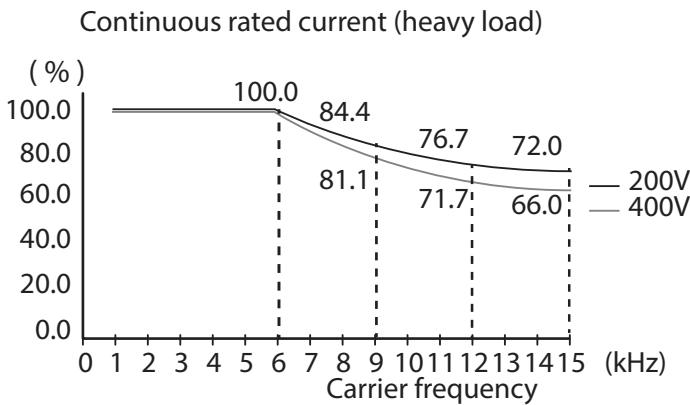

200V		400V	
Carrier Frequency (kHz)	Constant-rated Current (%)	Carrier Frequency (kHz)	Constant-rated Current (%)
1-6	100	1-6	100
9	84.4	9	81.1
12	76.7	12	71.7
15	72.0	15	66.0

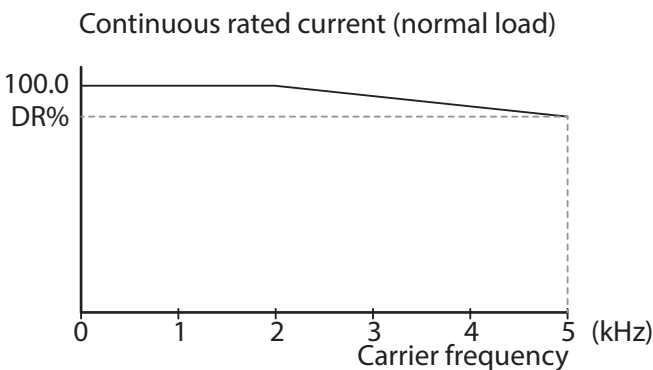

200V		400V	
Product (kW)	DR (%)	Product (kW)	DR (%)
5.5	85	5.5	81.3
7.5	85	7.5	77.2
11	86.6	11	85
15	90.2	15	84.2
		18.5	91.5
		22	83.2

Derating by Input Voltage

The continuous rated current of the inverter is limited based on the input voltage. Refer to the following graph.

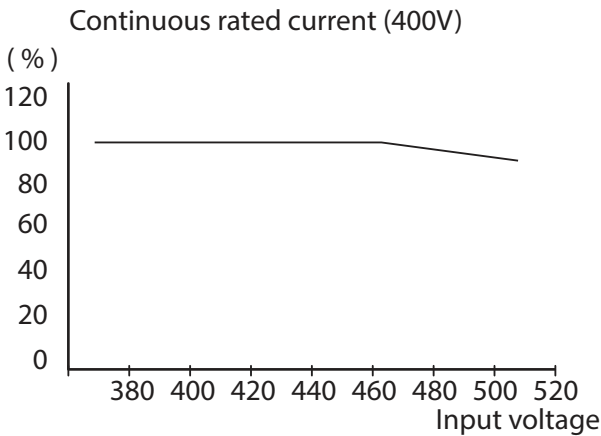
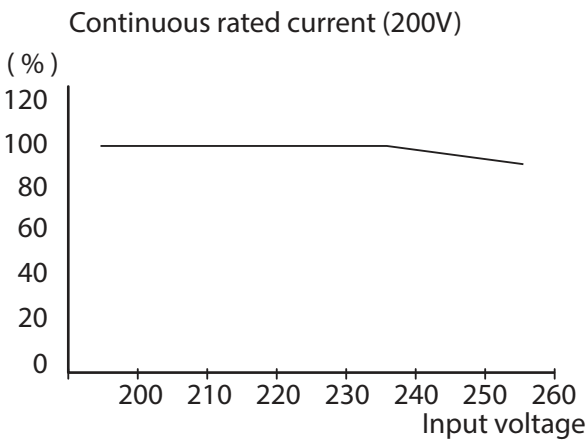

Derating by Ambient Temperature and Installation Type

The constant-rated current of the inverter is limited based on the ambient temperature and installation type. Refer to the following graph.

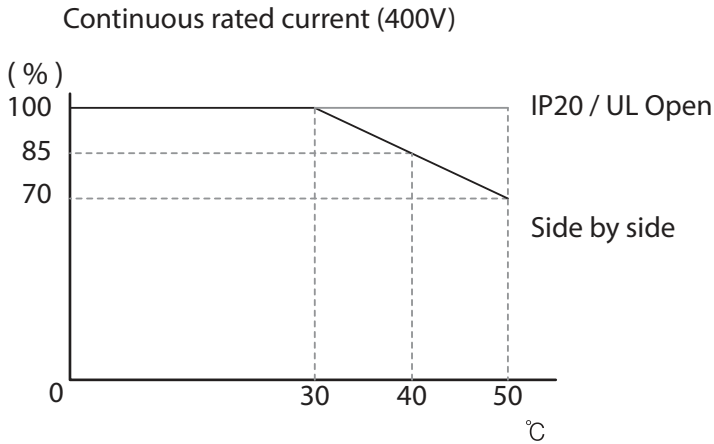

11.9 Heat Emmission

The following graph shows the inverters’ heat emission characteristics (by product capacity).

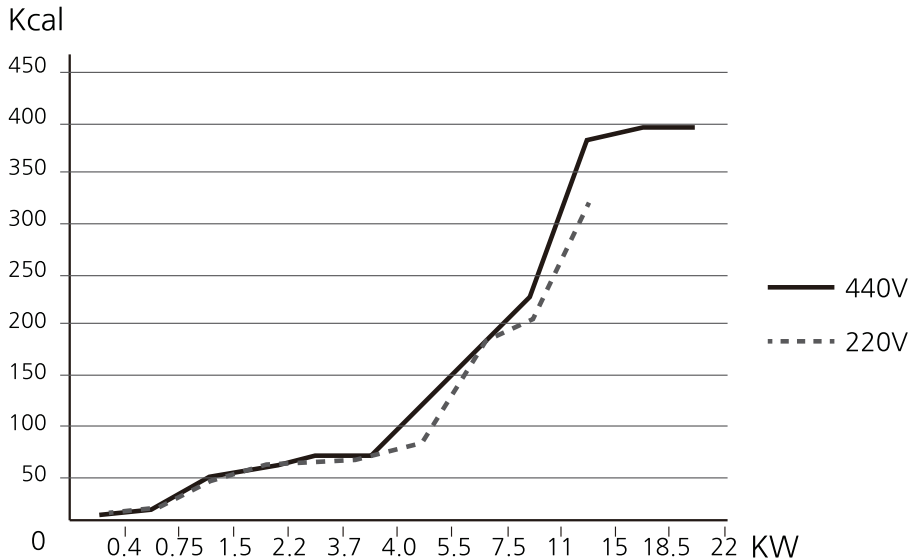

Heat emission data is based on operations with default carrier frequency settings, under normal operating conditions. For detailed information on carrier frequency, refer to [5.16 Operational Noise Settings \(carrier frequency settings\)](#) on page 164.

Product Warranty

Warranty Information

Fill in this warranty information form and keep this page for future reference or when warranty service may be required.

Product Name	LSIS Standard Inverter	Date of Installation	
Model Name	LSLV-S100	Warranty Period	
Customer Info	Name (or company)		
	Address		
	Contact Info.		
Retailer Info	Name		
	Address		
	Contact info.		

Warranty Period

The product warranty covers product malfunctions, under normal operating conditions, for 12 months from the date of installation. If the date of installation is unknown, the product warranty is valid for 18 months from the date of manufacturing. Please note that the product warranty terms may vary depending on purchase or installation contracts.

Warranty Service Information

During the product warranty period, warranty service (free of charge) is provided for product malfunctions caused under normal operating conditions. For warranty service, contact an official LSIS agent or service center.

Non-Warranty Service

A service fee will be incurred for malfunctions in the following cases:

- intentional abuse or negligence
- power supply problems or from other appliances being connected to the product
- acts of nature (fire, flood, earthquake, gas accidents etc.)
- modifications or repair by unauthorized persons
- missing authentic LSIS rating plates
- expired warranty period

Visit Our Website

Visit us at <http://www.lsis.com> for detailed service information.

EC DECLARATION OF CONFORMITY

We, the undersigned,

Representative: **LSIS Co., Ltd.**
Address: **LS Tower, Hoge-dong, Dongan-gu,
Anyang-si, Gyeonggi-do 1026-6,
Korea**

Manufacturer: **LSIS Co., Ltd.**
Address: **181, Samsung-ri, Mokchon-Eup,
Chonan, Chungnam, 330-845,
Korea**

Certify and declare under our sole responsibility that the following apparatus:

Type of Equipment: **Inverter (Power Conversion Equipment)**
Model Name: **LSLV-S100 series**
Trade Mark: **LSIS Co., Ltd.**

conforms with the essential requirements of the directives:

2006/95/EC Directive of the European Parliament and of the Council on the harmonisation of the laws of Member States relating to Electrical Equipment designed for use within certain voltage limits

2004/108/EC Directive of the European Parliament and of the Council on the approximation of the laws of the Member States relating to electromagnetic compatibility

based on the following specifications applied:

**EN 61800-3:2004
EN 61800-5-1:2007**

and therefore complies with the essential requirements and provisions of the 2006/95/CE and 2004/108/CE Directives.

Place: **Chonan, Chungnam,
Korea**

 2012. 2. 1

Mr. In Sik Choi / General Manager
(Full name / Position)

(Signature/Date)

UL mark



The UL mark applies to products in the United States and Canada. This mark indicates that UL has tested and evaluated the products and determined that the products satisfy the UL standards for product safety. If a product received UL certification, this means that all components inside the product had been certified for UL standards as well.

CE mark



The CE mark indicates that the products carrying this mark comply with European safety and environmental regulations. European standards include the Machinery Directive for machine manufacturers, the Low Voltage Directive for electronics manufacturers and the EMC guidelines for safe noise control.

Low Voltage Directive

We have confirmed that our products comply with the Low Voltage Directive (EN 61800-5-1).

EMC Directive

The Directive defines the requirements for immunity and emissions of electrical equipment used within the European Union. The EMC product standard (EN 61800-3) covers requirements stated for drives.

EMI / RFI POWER LINE FILTERS

LSis inverters, S100 series



RFI FILTERS

THE RANGE OF POWER LINE FILTERS FB (Standard) and FF (Filtered) SERIES, HAVE BEEN SPECIFICALLY DESIGNED WITH HIGH FREQUENCY LEAK REDUCTION. THE USE OF LB FILTERS, WITH THE INSTALLATION ADVICE OVERLAP HELP TO INSURE TROUBLE FREE USE ALONG SIDE SENSITIVE DEVICES AND COMPLIANCE TO CONDUCTED EMISSION AND IMMUNITY STANDARDS TO EN 50081.

CAUTION

IN CASE OF A LEAKAGE CURRENT PROTECTIVE DEVICES IS USED ON POWER SUPPLY, IT MAY BE FAULT AT POWER-ON OR OFF. IN AVOID THIS CASE, THE SENSE CURRENT OF PROTECTIVE DEVICE SHOULD BE LARGER

RECOMMENDED INSTALLATION INSTRUCTIONS

To conform to the EMC directive, it is necessary that these instructions be followed as closely as possible. Follow the usual safety procedures when working with electrical equipment. All electrical connections to the filter, inverter and motor must be made by a qualified electrical technician.

- 1-) Check the filter rating label to ensure that the current, voltage rating and part number are correct.
- 2-) For best results the filter should be fitted as closely as possible to the incoming mains supply of the wiring enclosure, usually directly after the enclosure's circuit breaker or supply switch.
- 3-) The back panel of the wiring cabinet of board should be prepared for the mounting dimensions of the filter. Care should be taken to remove any paint etc... from the mounting holes and face area of the panel to ensure the best possible earthing of the filter.
- 4-) Mount the filter securely.
- 5-) Connect the mains supply to the filter terminals marked **LINE**, connect any earth cables to the earth stud provided. Connect the filter terminals marked **LOAD** to the mains input of the inverter using short lengths of appropriate gauge cable.
- 6-) Connect the motor and fit the fan/fan cage (output choke) as close to the inverter as possible. Armoured or screened cable should be used with the 3 phase conductors only threaded twice through the center of the ferrite core. The earth conductor should be securely earthed at both inverter and motor ends. The screen should be connected to the enclosure body via an earthed cable gland.
- 7-) Connect any control cables as instructed in the inverter instructions manual.

IT IS IMPORTANT THAT ALL LEAD LENGTHS ARE KEPT AS SHORT AS POSSIBLE AND THAT INCOMING MAINS AND OUTGOING MOTOR CABLES ARE KEPT WELL SEPARATED.

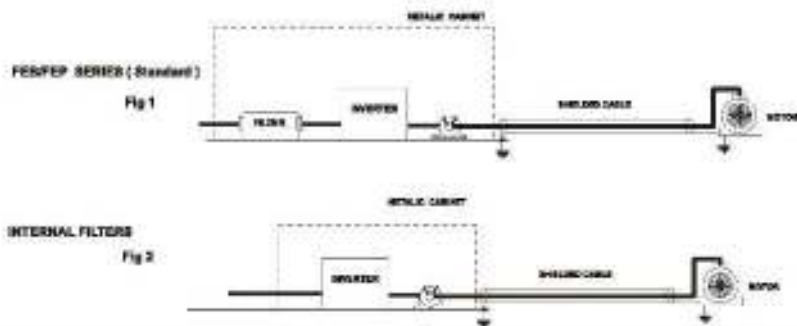

PRO004

LSLV series		Footprint Filters												
INVERTER	POWER	CODE	CURRENT	VOLTAGE	LOADING CURRENT	DIMENSIONS L W H			MOUNTING Y X		WEIGHT	MOUF	PC	OUTPUT CABLES
SINGLE PHASE			NOM. MAX.											
LSLV0045 E0-1	0.4kW	FFB100-M010-2	10A	250 VAC	0.5mA	175 x 71.5 x 45	82 x 82	100g	MA	B	FS-1			
LSLV0085 E0-1	0.75kW	FFB100-M011-2	10A	250 VAC	0.5mA	175 x 103.5 x 45	82 x 82	0.8kg	MA	B	FS-1			
LSLV0155 E0-1	1.5kW	FFB100-M020-2	20A	250 VAC	0.5mA	175 x 103.5 x 45	82 x 82	0.8kg	MA	B	FS-2			
LSLV0225 E0-1	2.2kW	FFB100-M021-2	20A	250 VAC	0.5mA	175 x 143.5 x 45	102 x 102	0.8kg	MA	B	FS-2			
THREE PHASE			NOM. MAX.											
LSLV0045 E0-2	0.4kW	FFS100-T006-2	5A	250 VAC	0.27A 10mA	175 x 71.5 x 45	82 x 82	100g	MA	B	FS-2			
LSLV0085 E0-2	0.75kW	FFS100-T010-2	10A	250 VAC	0.17A 10mA	175 x 103.5 x 45	82 x 82	100g	MA	B	FS-2			
LSLV0155 E0-2	1.5kW	FFS100-T012-2	10A	250 VAC	0.17A 10mA	175 x 103.5 x 45	82 x 82	100g	MA	B	FS-2			
LSLV0225 E0-2	2.2kW	FFS100-T012-2	10A	250 VAC	0.17A 10mA	175 x 103.5 x 45	82 x 82	100g	MA	B	FS-2			
LSLV0075 E0-2	0.7kW	FFS100-T028-2	20A	380 VAC	0.17A 10mA	175 x 143.5 x 45	102 x 102	1.8 kg	MA	B	FS-2			
LSLV0085 E0-2	0.8kW	FFS100-T028-2	20A	380 VAC	0.17A 10mA	175 x 143.5 x 45	102 x 102	1.8 kg	MA	B	FS-2			
THREE PHASE			NOM. MAX.											
LSLV0045 E0-4	0.4kW	FFS100-T006-2	5A	380-400VAC	0.27A 10mA	175 x 71.5 x 45	102 x 82	100g	MA	B	FS-2			
LSLV0085 E0-4	0.75kW	FFS100-T010-2	10A	380-400VAC	0.17A 10mA	175 x 103.5 x 45	102 x 82	100g	MA	B	FS-2			
LSLV0155 E0-4	1.5kW	FFS100-T012-2	10A	380-400VAC	0.17A 10mA	175 x 103.5 x 45	102 x 82	100g	MA	B	FS-2			
LSLV0225 E0-4	2.2kW	FFS100-T012-2	10A	380-400VAC	0.17A 10mA	175 x 103.5 x 45	102 x 82	100g	MA	B	FS-2			
LSLV0075 E0-4	0.7kW	FFS100-T028-2	20A	380-400VAC	0.17A 10mA	175 x 143.5 x 45	102 x 102	1.8 kg	MA	B	FS-2			
LSLV0085 E0-4	0.8kW	FFS100-T028-2	20A	380-400VAC	0.17A 10mA	175 x 143.5 x 45	102 x 102	1.8 kg	MA	B	FS-2			

EN 50111 CLASS B IECEN 61000-3-C2

LSLV series		Standard Filters													
INVERTER	POWER	CODE	CURRENT	VOLTAGE	LOADING CURRENT	DIMENSIONS L W H			MOUNTING Y X		WEIGHT	MOUF	PC	OUTPUT CABLES	
THREE PHASE			NOM. MAX.												
LSLV0225 100-2	2.2kW	FLD 3042	42A	220-480VAC	0.5mA 20mA	305 x 82 x 150	35 x 320	2.8kg	---	A	FS-1				
LSLV0155 100-2	1.5kW	FLD 3055	55A	220-480VAC	0.5mA 20mA	305 x 82 x 150	35 x 320	3.8kg	---	A	FS-2				
LSLV0185 100-2	1.8kW	FLD 3075	75A	220-480VAC	0.5mA 20mA	365 x 82 x 150	35 x 320	4kg	---	A	FS-2				
LSLV0305 100-2	3kW	FLD 3199	100A	220-480VAC	0.5mA 20mA	380 x 82 x 220	55 x 314	5.9kg	---	A	FS-1				
LSLV085 100-2	0.85kW	FLD 3198	100A	220-480VAC	0.5mA 20mA	30 x 82 x 220	55 x 314	7.9kg	---	A	FS-1				
LSLV0305 100-2	3kW	FLD 3198	100A	220-480VAC	0.5mA 20mA	30 x 82 x 220	55 x 314	7.9kg	---	A	FS-1				

LSLV0085-0225 5100-2 EN 50111 CLASS A IECEN 61000-3-C3

LSLV series		Internal Filters		
INVERTER	POWER	FC	OUTPUT CABLES	
THREE PHASE				
LSLV0225 100-4	2.2kW	2	FS-2	
LSLV0155 100-4	1.5kW	2	FS-2	
LSLV0185 100-4	1.8kW	2	FS-2	
LSLV0305 100-4	3kW	2	FS-3	
LSLV085 100-4	0.85kW	2	FS-3	
LSLV0305 100-4	3kW	2	FS-3	

EN 50111 CLASS B IECEN 61000-3-C3

F8B SERIES (Standard)

FIG. A

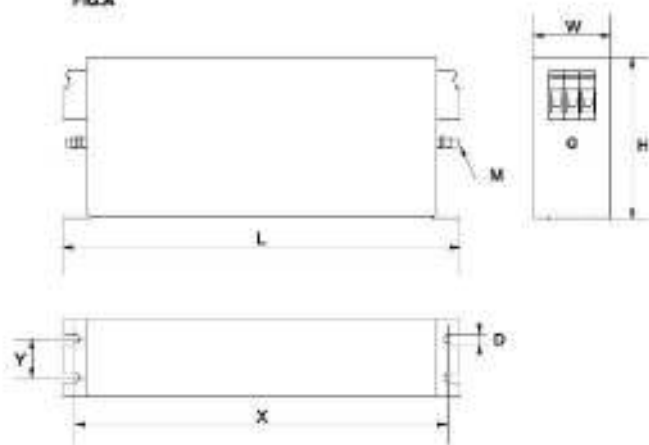

FF SERIES (Footprint)

FIG. B

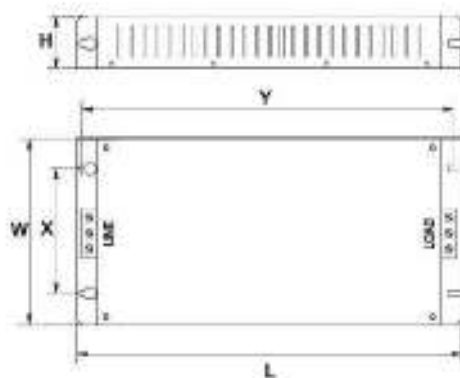

LSIS VMC
vector motor control

Vector Motor Control Ibérica S.L.
C/ Mar del Caribe, 10
Pol. Ind. La Torre del Rector
08130 Santa Perpètua de Mogoda
(BARCELONA) ESPAÑA
Tel. (+34) 935 748 208
Fax (+34) 935 748 288
info@vmc.es
www.vmc.es



F8B SERIES (output choke)

CODE	Q	W	H	E	B
F8-1	21	81	33	20	1
F8-2	25.5	90	32	20	0
F8-3	42	100	100	100 x 30	0

FIG004

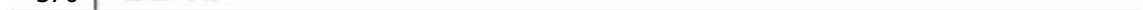

Index

2

2 square reduction.....	64
24 terminal.....	32, 34
2nd Motor group...Refer to <i>M2(2nd Motor) group</i>	
2nd Motor Operation.....	166
2 nd Operation mode.....	106
2 nd command source.....	107
Shared command (Main Source).....	107

3

3-phase 200V (0.4~4k W).....	342
3-phase 200V (5.5~15 kW).....	343
3-phase 400V (0.4~4 kW).....	344
3-phase 400V (5.5~22 kW).....	345
3-Wire Operation.....	130

4

4-pole standard motor.....	341, 344, 345
----------------------------	---------------

7

7-segment display.....	44
letters.....	44
numbers.....	44

A

A terminal (Normally Open).....	108
A1/C1/B1 terminal.....	32
AC power input terminalRefer to <i>R/S/T terminal</i>	
Acc/Dec pattern.....	64, 91
linear pattern.....	91
S-curve pattern.....	91
Acc/Dec reference.....	88
Delta Freq.....	87

Max Freq.....	87
Acc/Dec reference frequency.....	86
Ramp T Mode.....	86
Acc/Dec stop.....	94
Acc/Dec time.....	86
Acc/Dec time switch frequency.....	90
configuration via multi-function terminal.....	88
maximum frequency.....	86
operation frequency.....	88
accumulated electric energy initialize.....	176
Ad (Expanded function group).....	261
Ad(Advanced) group.....	46
Add User group	
UserGrp SelKey.....	174
Advanced group..... Refer to <i>Ad(Advanced) group</i>	
analog frequency hold.....	77
Analog Hold.....	77
Analog Hold..... Refer to <i>analog frequency hold</i>	
analog input.....	30, 46
I2 current input.....	72
I2 voltage input.....	74
TI Pulse input.....	74
V1 voltage input.....	67
analog input selection switch(SW2).....	28, 74
analog output.....	31, 46
AO terminal.....	31
pulse output.....	184
voltage and current output.....	181
Analog Output.....	181
analog output selection switch(SW3).....	28, 181
AO terminal.....	31, 84, 181
analog output selection switch(SW3).....	28
AP(Application Function group).....	285
AP(Application group).....	46
Application group..Refer to <i>AP(Application) group</i>	
ARM short current fault trip..... Refer to <i>Over Current2</i>	
ASCII code.....	230
asymmetric ground power.....	35

asymmetric ground structure	
EMC filter	35
asynchronous communications system.....	219
auto restart settings.....	163
auto torque boost.....	98
auto tuning	98, 144
auto tuning.....	144
All(rotating).....	145
All(static).....	145
default parameter setting.....	145
Tr(static).....	145
Auto Tuning.....	258
auxiliary frequency	122
auxiliary frequency reference configuration	123
auxiliary reference	122
auxiliary reference gain	123
configuration	122
final command frequency calculation	124
main reference	122

B

B terminal (Normally Closed)	108
bA(Basic function group)	256
bA(Basic group).....	46
basic configuration diagram	14
Basic group.....	Refer to <i>bA(Basic) group</i>
basic operation	43
bit 108	
bit (Off)	108
bit (On).....	108
bit setting.....	108
multi-function input setting	108
multi-function output setting.....	191
speed search setting.....	160
stall prevention	201
Bootlace Ferrule	33
brake control.....	178
BR Control	178
brake engage sequence	178
brake release sequence.....	178
brake resistor.....	26
brake unit.....	180

braking resistance	
braking torque	358
braking resistors.....	14
broadcast.....	227
built-in communication.....	Refer to <i>RS-485</i> BX217, 325

C

cable	10, 20, 22, 23, 24, 27
selection.....	10, 20, 22, 23, 24, 27
shielded twisted pair	39
signal(control) cable specifications.....	11
Cable	
Ground Specifications.....	10
Power I/O Cable Specifications	10
cable tie	33
carrier frequency.....	26, 165
derating.....	359
factory default	165
charge indicator	19, 323, 329
charge lamp	19
cleaning	335
CM terminal	30, 34
CM(communication function group).....	280
CM(Communication group).....	46
Cn (Control Function group).....	266
Cn(Control) group	46
code number input	48
command.....	79
configuration	79
Command	
Cmd Source	79
command source	
keypad	79
Command source	
fwd/rev command terminal	80
RS-485.....	81
run command/rotational direction configuration	81
commercial power source transition	167
common terminal.....	Refer to <i>EG terminal</i>

communication.....	219
command loss protective operation	223
communication address.....	232
communication line connection.....	220
communication parameters.....	220
communication speed	221
communication standards	219
memory map.....	225
PLC	219
protocol.....	226
saving parameters defined by communication	224
setting virtual multi-function input	223
Communication group.....	<i>CM(Refer to Communication) group</i>
compatible common area parameter.....	235
config (CNF) mode.....	176
Considerations for the installation	
Air Pressure.....	5
Altitude/Vibration.....	5
Ambient Humidity.....	5
Environmental Factors.....	5
Considerations for the installation	
Ambient Temperature.....	5
contact	
A contact	205
B contact.....	205
Control group.....	<i>Refer to Cn(Control) group</i>
control terminal board wiring.....	27
cooling fan	
fan Operation accumulated time	195
fan Operation accumulated time initialization.....	195
Cooling Fan	168
Fan Control.....	168
cooling fan malfunction.....	211
CPU Watch Dog fault trip	217

D

DB resistor	
braking resistor circuit.....	208
DB Warn %ED.....	208
DB Warn %ED.....	<i>Refer to DB Warn %ED</i>
DC braking after start.....	100

DC braking after stop.....	101
DC braking frequency.....	101
DC link voltage	121, 154
delta wiring.....	36
derating	165
Digital Output.....	187
digital source.....	83
disposal.....	335, 339
dr(Drive group).....	46, 251
draw operation.....	121
Drive group.....	<i>Refer to dr(Drive) group</i>
Dwell Operation.....	133
Acc/Dec dwell frequency.....	133
acceleration Dwell.....	133
deceleration Dwell.....	133

E

earth leakage breaker.....	332
EEP Rom Empty.....	170
EG terminal	32
electronic thermal overheating protection (ETH)	
.....	197
EMC filter.....	35
asymmetric power.....	35
disable.....	35
enable	36
emergency stop fault trip.....	<i>Refer to BX</i>
energy buttferring operation.....	154
energy saving operation	158
automatic energy saving operation.....	158
manual energy saving operation.....	158
error code.....	230
FE(frame error).....	230
IA(illegal data address).....	230
ID(illegal data value).....	230
IF(illegal function).....	230
WM(write mode error).....	230
ESC key	45
[ESC] key configuration	128
[ESC] key setup.....	82

cancel input	45
Jog key	50
local/remote switching.....	82
multi-function key.....	82
remote / local operation switching.....	83
ETH.....Refer to <i>electronic thermal overheating protection (ETH)</i>	
E-Thermal.....	217
Exciting Current	149
external 24V power terminal.. Refer to <i>24 terminal</i>	
external dimensions	
0.8~1.5kW(Single Phase), 1.5~2.2kW(3 Phase).....	350
5.5~22kW(3 phase).....	353
External dimensions.....	348
External dimensions	
0.4kW(Single Phase), 0.4~0.8kW(3 Phase)	348
External Trip	217, 324
external trip signal.....	204

F

factory default	56, 58, 59
fan trip.....	211
Fan Trip.....	217, 325
fan warning.....	211
Fan Warning.....	218, 326
fatal	323
fault.....	216
fatal	323
fault/warning list.....	216
latch.....	323
level.....	323
major fault	217
fault signal output terminal	Refer to <i>A1/C1/B1 terminal</i>
FE(FRAME ERROR).....	230
ferrite.....	33
fieldbus.....	66, 79
communication option	106
Fieldbus.....	Refer to <i>fieldbus</i>
filter time constant.....	67

filter time constant number.....	107
flux braking.....	200
free run stop.....	102
frequency jump	105
frequency limit	104
frequency jump.....	105
frequency upper and lower limit value	104
maximum/start frequency.....	104
frequency reference.....	66, 99
frequency setting	66
I2 current input	72
I2 voltage input.....	74
keypad	66
RS-485.....	76
TI Pulse input.....	74
V1 voltage input.....	67
variable resistor.....	57
frequency setting (Pulse train) terminal..Refer to <i>I1 terminal</i>	
frequency setting(voltage) terminal.....Refer to <i>V1 terminal</i>	
fuse.....	355

G

ground.....	23
class 3 ground.....	23
class 3 ground.....	23
ground terminal.....	23
Ground	
Ground Cable Specifications	10
ground fault trip	Refer to <i>Ground Trip</i>
Ground Trip.....	217, 324
ground fault trip	324

H

half duplex system.....	219
Heavy Duty	5
heavy load	165, 341
hunting.....	153

I

I2	31, 72
analog input selection switch(SW2)	31
frequency setting(current/voltage) terminal	31
IA(illegal data address)	230
ID(illegal data value)	230
IF(illegal function)	230
In Phase Open	217, 324
In(Input Terminal Block Function group)	271
In(Input Terminal) group	46
input and output specification	
applied motor	341
rated input	341
rated output	341
input open-phase fault trip	Refer to <i>In Phase Open</i>
input phase open	
input open-phase protection	204
input power frequency	169
input power voltage	169
input terminal	30
CM terminal	30
I2 terminal	31
P1–P7 terminal	30
SA terminal	31
SB terminal	31
SC terminal	31
TI terminal	31
V1 terminal	31
VR terminal	30
Input Terminal group	Refer to <i>In(input terminal) group</i>
inspection	
annual inspection	336
bi-annual inspection)	338
installation	13
basic configuration diagram	14
Installation flowchart	13
wiring	19
Installation	
Mounting the Inverter	15

installation considerations	5, 335, 338
IP 20	347

J

Jog Operation	126
[ESC] key configuration	50
FWD Jog	126
Jog frequency	126
keypad	128
jump frequency	105

K

keypad	43
display	43
operation keys	43
S/W version	176
Keypad	
Keypad Language	193
keypad display	44
keypad key	45
[▲]/[▼]/[◀]/[▶] key	45
[ESC] key	45
[RUN] key	45
[STOP/RESET] key	45

L

latch	323
LCD keypad	23
LCD brightness/contrast adjustment	176
wiring length	33
leakage breaker	354
level	323
Lifetime diagnosis of components	
lifetime diagnosis for fans	213
lift-type load	91, 97, 98, 133
linear pattern	91
linear V/F pattern operation	94
linear V/F pattern Operation	
base frequency	95

start frequency.....	95
local operation	
[ESC] key	82
Local/Remote Mode Switching	82
remote operation	83
local Operation.....	83
locating the installation site.....	6
location.....	6
loop.....	111
loop time.....	114
Lost Command.....	217, 325, 326
command loss fault trip warning.....	217
command loss trip	217
low voltage	213
low voltage fault trip.....	213
low voltage trip 2.....	216
Low Voltage.....	217, 324
low voltage fault trip.....	217
LowLeakage PWM	165
LS INV 485 protocol	226

M

M2(2nd Motor Function group).....	293
M2(2nd Motor) group	46
magnetic contactor	27
Magnetic contactor	354
maintenance	335
manual torque boost.....	97
Master	219
master inverter.....	110
master unit.....	109
megger test.....	336
micro surge filter	26
momentary power interruption.....	154, 160, 162
monitor	60
monitor registration protocol details.....	229
Operation State Monitor.....	193
Operation time monitor.....	195
motor output voltage adjustment.....	98
motor protection.....	197

motor rotational direction.....	40
motor thermal protection(ETH)	
ETH trip.....	197
E-Thermal.....	197
mounting bolt	15
mounting bracket	17
multi function input terminal	
In.65~71	273
Px terminal function setting	273
multi function input terminal	
Px Define	273
multi keypad	
Multi KPD.....	110
multi keypad(Multi-keypad)	
slave parameter	110
multi-drop Link System.....	219
Multi-function (open collector) output terminal	
Multi-function output item1(Q1 Define).....	277
Multi-function relay 1 item(Relay 1)	277
multi-function input terminal	30
factory default	30
multi-function input terminal Off filter.....	107
multi-function input terminal On filter.....	107
P1~P7.....	Refer
multi-function input terminal control	107
multi-function key.....	44, 50
[ESC] key	50
Multi Key Sel	320
multi-function key options.....	320
multi-function output	
multi-function output terminal delay time settings	192
multi-function output terminal	
multi-function output on/off control	179
multi-function output terminal and relay settings	187
multi-function output terminal delay time settings	192
trip output by multi-function output terminal and relay.....	191
multi-function(open collector) output terminal	Refer to <i>Q1 terminal</i>
multi-keypad.....	110

master parameter	110
multi-keypad)	
setting	110
multi-step frequency	77
setting	77
Speed-L/Speed-M/Speed-H	78

N

N- terminal(- DC link terminal)	26
no motor trip	216
No Motor Trip	217, 324
noise	35, 69
Normal Duty	5
normal load	165, 341
Normal PWM	165
NPN mode(Sink)	35

O

oOut Phase Open	324
open-phase protection	203
Operation frequency	<i>Refer to frequency setting</i>
operation group	249
Operation group	46
operation noise	164
carrier frequency	165
frequency jump	105
Operation time	195
operation accumulated time	195
Operation accumulated time	195
Operation accumulated time initialization	195
option trip	215, Refer to <i>Option Trip-x</i>
Option Trip-x	217
option trip	217
OU(Output Terminal Block Function group)	276
OU(Output Terminal) group	46
Out Phase Open	217
output block by multi-function terminal	214
output open-phase fault trip	Refer to <i>Out Phase</i>

Open

output terminal	Refer to <i>R/S/T terminal</i>
Output Terminal group	Refer to <i>OU(output terminal) group</i>
output/communication terminal	31
24 terminal	32
A1/C1/B1 terminal	32
AO terminal	31
EG terminal	32
Q1 terminal	32
S+/S-/SG terminal	32
TO terminal	32
over current trip	Refer to <i>Over Current1</i>
Over Current1	217, 323
Over Current2	217, 324
Over Heat	217, 324
over heat fault trip	Refer to <i>Over Heat</i>
Over Load	217, 323
overload fault trip	217
overload warning	217, 326
Over Voltage	217, 324
over voltage trip	Refer to <i>Over Voltage</i>
overload	Refer to <i>Over Load</i>
overload overload trip	198
overload warning	198
overload rate	165
overload trip	Refer to <i>Over Load</i>

P

P/Igain	162
P1+ terminals(+ DC link terminals)	26
P2P	108
communication function	108
master parameter	109
setting	108, 109
slave parameter	109
parameter	49
display changed parameter	173
hide parameters	171
initialization	170
parameter lock	172

parameter setting.....	49
password.....	171, 172
read/write/save.....	170
parameter view lock.....	171
part names.....	3
parts illustrated.....	3
password.....	171, 246
Password.....	172
Peripheral devices.....	354
phase-to-phase voltage.....	330
PID control.....	136
basic PID operation.....	136
configuration.....	136
Differential time(PID D-Time).....	139
integral time(PID I-Time).....	139
oscillation.....	139
Pgain.....	138
PID control block diagram.....	141
PID feedback.....	325
PID Operation Sleep mode.....	142
PID output.....	138
PID reference.....	138
PID Switching.....	143
Pre-PID Operation.....	142
PNP mode(Source).....	34
PNP/NPN mode selection switch(SW1).....	28
NPN mode(Sink).....	35
PNP mode(Source).....	34
post-installation checklist.....	38
power consumption.....	193, 195
power slot.....	177
power terminal.....	26
N- terminal.....	26
P2+/B terminal.....	26
U/V/W terminal.....	26
power terminal board wiring.....	24
power terminals	
R/S/T terminals.....	26
Power-on Run..... Refer to <i>start at power-on</i>	
Pr(Protection Function group).....	288
Pr(Protection) group.....	46
pre-exciting time.....	150

Preinsulated Crimp Terminal.....	32
press regeneration prevention.....	180
Press regeneration prevention	
P gain/I gain.....	181
Protection group..... Refer to <i>Pr(Protection) group</i>	
protocol.....	226
LS INV 485 protocol.....	226
Pulse output terminal..... Refer to <i>TO terminal</i>	
PWM.....	164
frequency modulation.....	164

Q

Q1 terminal.....	32
quantizing..... Refer to <i>Quantizing</i>	
Quantizing.....	69
noise.....	69

R

R/S/T terminal.....	27
R/S/T terminals.....	26, 329
rated.....	342
braking resistance rated capacity.....	358
rated input.....	342
Rated	
rated output.....	342
rated torque current.....	182
rating	
rated motor current.....	135
rated motor voltage.....	144
rated slip frequency.....	135
rated slip speed.....	135
reactor.....	14, 355
regenerated energy.....	103, 154
remote operation.....	83
[ESC] key.....	82
local operation.....	83
Local/Remote Mode Switching.....	82
Reset Restart..... refer to <i>restarting after a trip</i>	
resonance frequency.....	105

carrier frequency.....	164
frequency jump.....	105
restarting after a trip.....	85
RS-232.....	219
communication.....	219
RS-485.....	219
communication.....	219
converter.....	219
integrated communication.....	76
signal terminal.....	32, 76
RS-485 signal input terminal.....	Refer to <i>S+/S-/SG terminal</i>
run prevention	
Fwd.....	84
Rev.....	84

S

S/W version.....	176
keypad.....	176
product.....	176
S+/S-/SG terminal.....	32
S100 expansion common area parameter	
control area parameter(Read/Write).....	243
memory control area parameter(Read/Write).....	245
monitor area parameter (read only).....	238
SA terminal.....	31
Safe Operation mode.....	131
safety information.....	ii
safety input power terminal.....	Refer to <i>SC terminal</i>
safety inputA terminal.....	Refer to <i>SA terminal</i>
Safety inputB terminal.....	Refer to <i>SB terminal</i>
SB terminal.....	31
SC terminal.....	31
screw specification	
control circuit terminal screw	357
input/output terminal screw.....	356
screw size.....	356
screw torque.....	356
S-curve pattern.....	91
actual Acc/Dec time.....	93
sensorless vector control.....	147

configuration.....	149
Hold Time.....	150
Igain.....	150
IM Sensorless.....	149
Pgain.....	150
pre-exciting time.....	150
sensorless vector control operation guide.....	152
sequence common terminal.....	Refer to <i>CM terminal</i>
serge killer.....	38
setting virtual multi-function input.....	223
single phase 200V (0.4~2.2 kW).....	341
Slave.....	219
slave inverter.....	110
slave unit.....	109
Slip.....	134
slip compensation operation.....	134
speed command loss.....	206
speed search operation.....	159
Flying Start-1.....	160
Flying Start-2.....	160
options.....	160
P/Igain.....	162
speed unit selection (Hz or Rpm).....	77
Square reduction	
Square reduction load.....	95
V/F pattern Operation.....	95
stall	
bit on/off.....	201
stall prevention.....	200
Stall.....	200
start at power-on.....	84
start mode.....	99
acceleration start.....	99
start after DC braking.....	100
Station.....	110
Station ID.....	232
stop mode.....	100
DC braking after stop.....	101
deceleration stop.....	100
free run stop.....	102
power braking.....	103

storage	338
Storing Temperature	5
surge killer	27
SW1	Refer to <i>PNP/NPN mode selection switch(SW1)</i>
SW2	Refer to <i>analog input selection switch(SW2)</i>
SW3	Refer to <i>analog output selection switch(SW3)</i>
switch	28
analog input selection switch(SW2)	28
analog output selection switch(SW3)	28
PNP/NPN mode selection switch(SW1)	28

T

target frequency	
Cmd Frequency	251
technical specification	341
terminal	108
A terminal	108, 192
B terminal	108, 192
terminal for frequency reference setting	Refer to <i>VR terminal</i>
test run	39
TI terminal	31, 74
time scale	
0.01sec	87
0.1sec	87
1sec	87
time scale setting	86
Timer	177
TO terminal	32, 184
torque	26
torque control	155
torque reference setting option	156
torque boost	97
auto torque boost	98
manual torque boost	97
overexcitation	98
trip	323
fault/waring list	216
trip condition monitor	61

trip status reset	214
Trip	
troubleshooting	327
trip(Trip)	
Erase trip history	176
troubleshooting	323
other faults	329
troubleshooting fault trips	327

U

U&M mode	174
U/V/W terminal	26, 27
U/V/W terminals	329
UF298	
UF(User Sequence Function) group	46
under load	
under load trip	209
under load warning	209
Under Load	217
underload fault trip	217
underload trip	323
underload warning	217, 326
underload fault trip	Refer to <i>Under Load</i>
update	176, 229
Up-Down Operation	129
US295	
US(User Sequence) group	46
user group	173
delete parameters	174
user group	
parameter registration	174
user sequence	111
function block parameter	114
setting	111
UF group	111
US group	111
user function operation condition	114
void parameter	111, 114
User Sequence Function group	Refer to <i>UF(User Sequence Function) group</i>

User Sequence group...Refer to <i>US(user sequence)</i> <i>group</i>	
user V/F pattern Operation.....	96
using the keypad.....	47
groups/codes.....	47
Jog Operation key	50
moving directly to a code	48
using the using the keypad	
parameter setting.....	49

V

V/F control.....	94
linear V/F pattern operation.....	94
Square reduction V/F pattern Operation.....	95
user V/F pattern Operation.....	96
V1 terminal.....	31, 67
V2	
analog input selection switch(SW2).....	31
V2 input.....	74
I2 voltage input.....	74
variable resistor.....	57
variable torque load.....	95, 155
voltage drop	26

voltage/current output terminal.....	Refer to <i>AO terminal</i>
VR terminal	30, 67

W

warning	323
Warning	
fault/warning list.....	216
weight	341
wiring.....	19
3 core cable	26
circuit breaker	354
control terminal board wiring.....	27
copper cable.....	19
cover disassembly.....	19
ferrite	33
ground.....	23
power terminal board wiring.....	24
re-assembling the covers	37
signal wiring	32
torque.....	19
wiring length.....	26, 33
WM(write mode error).....	230