

Foreword

Thank you very much for purchasing PR5200 soft starter.

This User's Manual provides the users with the instructions on the installation, parameter setting, error diagnosis, remote control software instruction, routine maintenance and necessary precautions. Please read the Manual carefully before the installation of the product in order to ensure that it can be correctly installed and operated.

Please contact Powtran's dealers or directly contact with the company if you have difficult questions during the use of the soft starter , our professional staff is willing to serve for you.

Please leave this manual to the end user and keep it in good condition for the future maintenance and other application occasions . Please fill in the warranty card then fax to the distributor or fax to Powtran if there is quality problem during the warranty period.

During this product updating period, some details may be changed without prior notice. If you want to get the latest information, please visit our website.

For other products' information, Please visit our homepage : <http://www.powtran.com>.

Contents

Precaution.....	4
Section I The introduction of PR5200 soft starter.....	1
1-1. The feature of the PR5200 soft starter	1
1-2. The main function of the PR5200 soft starter.....	1
1-3. The main features of the PR5200 soft starter.....	1
Section II Product model description and open package inspection.....	3
2-1. The steps of open package inspection.....	3
Section III The Conditions of use and installation requirements.....	4
3-1. The Conditions of use of the soft starter	4
3-2. The installation requirements of the soft starter.....	4
3-3. The appearance and installation dimension of the soft starter	5
Section IV Main circuit and terminal wiring	7
4-1. The basic wiring diagram of the soft starter	7
4-2. Instruction of soft starter terminal wiring.....	8
Section V Control panel and operation	10
5-1 Keyboard operational approach.....	10
5-2 Function parameters setting and description	12
5-3 Programmable relay output functions	13
5-4 Automatic restart function.....	14
5-5 Other settings Description.....	15
5-6 .Help and instructions.....	16
Section VI Protection and description.....	17
6-1 Protection functions and their parameters	17
6-2 Protection level setting description.....	18
Section VII Test runing and application	20
7-1. Power test running.....	20
7-2. PR5200 Series soft starter starting mode and application.....	21
7-3. PR5200 series soft starter's stop mode and application	23
7-4. Special application	24
7-5. Application examples	24
Section VIII RS485 communication	26
Section IX Fault causes and treatment.....	27
Section X Soft-start model specifications and options.....	29
Section XI Quality Assurance	30

POWTRAN Technology Product Warranty Card- 31 -
Product information feedback- 34 -

Precaution

- thanks for selecting intelligent motor soft starter products from Powtran technology Co., LTD., we will with excellent performance in return for your attention!
- Please pay attention to the following matters during the soft starter installation, operation and maintenance process



please be sure to read the operating instructions before installation



Must by professional technicians to install the soft starter



The specifications of the motor must match with the soft starter



Prohibit to connect the capacitors in soft starter output terminal (U, V, W)



the bare terminals must be wrapped by insulating tape after installation



Soft starter or related equipment should be reliable grounding



Input power must be cut off when equipment maintenance



Do not disassemble , modify, maintenance of this product personally.

Only trained people are allowed to operate this device, please read this manual about the safety, installation, operation, and maintenance section before use of the items. The safe application of this equipment depends on the correct transportation, installation, operation and maintenance.

Section I The introduction of PR5200 soft starter

1-1. The feature of the PR5200 soft starter

PR5200 series intelligent motor soft starter incorporates the latest motor control theory and proprietary motor protection technology and advanced software technology of new equipment, it is an ideal replacement of startup products which early used start method of “Star to Triangle conversion”, “autoformer step-down voltage” and “magnetic control step-down voltage” ; At present market ,Its performance is more superior than other ordinary soft starter without using intelligent control technology.

1-2. The main function of the PR5200 soft starter

- First: to reduce the motor starting current and reduce power distribution capacity, avoid investment of expansion of power capacity.
- The second: to reduce the starting stress of the motor and the load of the equipment ; Extend lifespan of the motor and related equipments.
- Third: Its soft stop function can effectively solve the problem of parking vibration of the inertial system,which is unable to realize by traditional starting equipment.
- Fourth: to have six unique start-up modes adapts to the complex conditions of motor and load, to perfect start effect.
- Fifth: has the perfect and reliable protection function; Effectively protect the motor and the related production equipment use safety.
- Sixth: motor soft starter intelligence, and network technology application makes motor control technology to adapt to the rapid development of the electric power automation technology in higher requirements.

1-3. The main features of the PR5200 soft starter

● perfect human nature design:

- beautiful shape and reasonable structure
- perfect function and easy operation
- sturdy and reliable and compact structure
- industrial product excellence in the design of art.

● Reliable quality assurance:

- using the computer simulation design.
- SMT placement production process.
- excellent electromagnetism compatibility.
- The whole machine of aging, vibration test in high temperature before they leave the factory

● perfect and reliable protection function:

- Voltage lose, lower voltage and over-voltage protection.
- soft starter motor overheating, lower load, too long starting time protection.
- input phase lose, output phase lose, three-phase unbalance protection.
- Startup current, overload, short circuit protection.

● **proprietary intellectual property products:**

- appearance design patent.
- independent software copyright.
- proprietary motor starting and protection technology.
- unique testing debugging equipment and process.

● **swift thoughtful after-sales service:**

- reliable performance and lay the foundation of quality service quality.
- provide excellent perfect supporting design scheme.
- timely and thoughtful use consultation.
- Continuously improve product performance according to user opinion

Section II Product model description and open - package inspection

Each PR5200 series soft starter is under strict inspection and testing before they leave the factory. Users received the products and unpacked, please follow the inspection steps , if found, please contact the supplier promptly

2-1. The steps of open - package inspection

- ◆ Confirm the soft starter without any damage in transport process (machine body damage or gap).
- ◆ Check with the machine, the instruction manual, the warranty card
- ◆ Check the product of the specifications of the enclosure panels, ensure that the received goods match with you ordered products

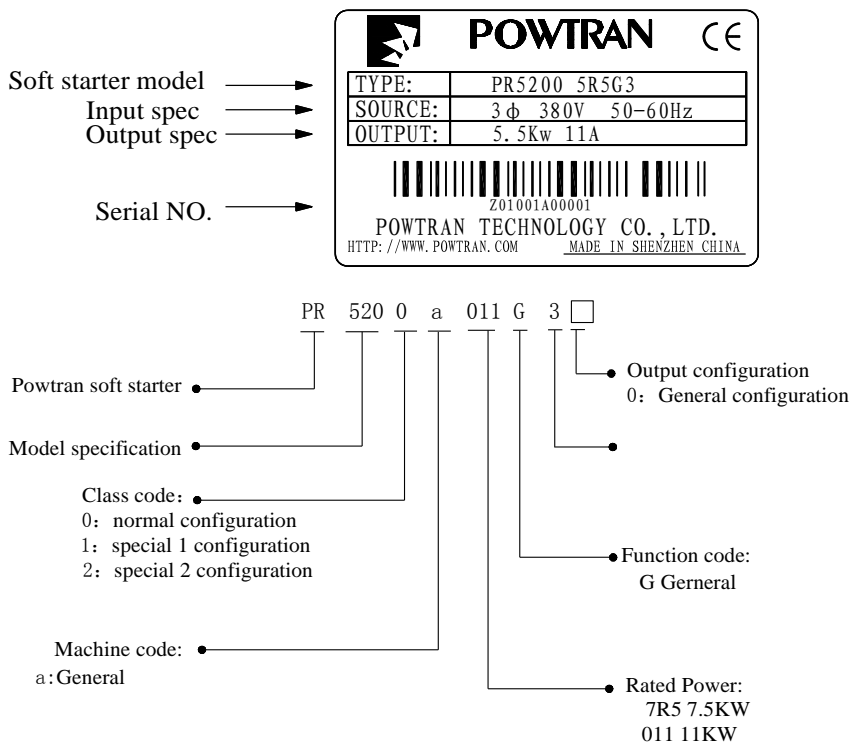

Section III The Conditions of use and installation requirements

PR5200 series soft starter should comply with the following conditions of use and installation requirements; Otherwise, the performance will not guarantee, it can shorten life of soft starter even damage.

3-1. The Conditions of use of the soft starter

- 3-1-1. Power supplies: the utility, self-power station, diesel generating sets three-phase AC 380 V or 660 V plus or minus 15%, frequency 50 Hz or 60 Hz, the power supply capacity must meet soft starter motor starting to the requirement
 - 3-1-2. Applicable motor: mouse cage type three-phase asynchronous motor, electrical power rating should with soft starter rated power match.
 - 3-1-3. Start frequency: no demands, depending on the specific number load up.
 - 3-1-4. Cooling way: air cooling.
 - 3-1-5. The protective level: IP20.
 - 3-1-6. Environmental conditions: elevation 3000 meters, the environment temperature-25 °C ~ + 40 °C between, relative humidity below 90% RH, no dewing, no inflammable, no explosive, no corrosive gas easily, have no electrical conductivity dust, indoor and ventilated good, vibration is less than 0.5 G place.
- ★ We can offer under special conditions of use products, such as the explosion proof type, low temperature, high pressure type type soft starter, its use conditions will need further instructions.

3-2. The installation requirements of the soft starter

- Installation direction and distance: in order to ensure that the soft starter in use with good ventilation and cooling conditions, soft starter should be installed vertically, and in the equipment with sufficient heat dissipation space all round, as shown in chart 3.2 3.1, in the photo, to allow the minimum distance.
- Soft starter install inside ark, in addition to the above requirements outside, still must choose, under ventilated cabinet put oneself in another's position, as shown in chart 3.3.

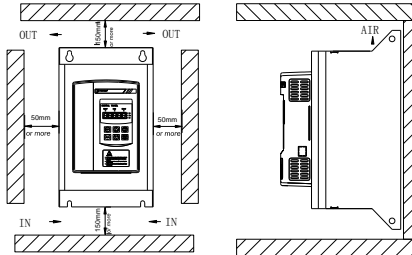

3-3. The appearance and installation dimension of the soft starter

3-3-1. The appearance and installation dimension of the 5.5KW-55KW soft starter. chart3.1

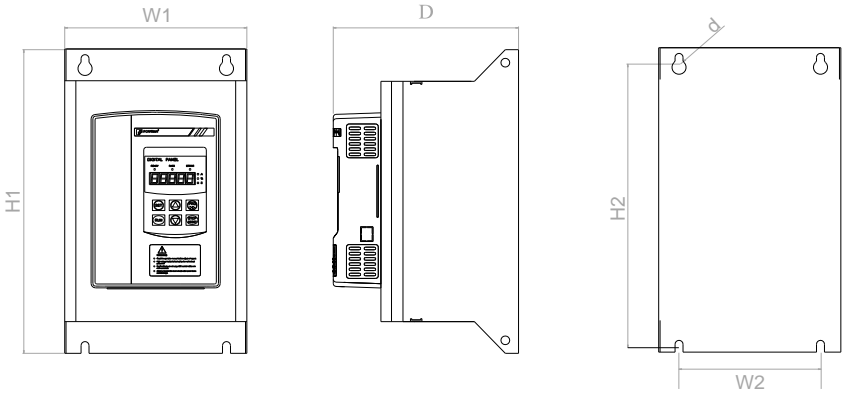

Model	Rated Power (KW)	Rated current (A)	Dimension			Installation			Net(kg)
			H1	W1	D	H2	W2	d	
PR5200 5R5G3	5.5	11	288	146	159	270	115	Ø8	<3.5
PR5200 7R5G3	7.5	15	288	146	159	270	115	Ø8	<3.5
PR5200 011G3	011	22	288	146	159	270	115	Ø8	<3.5
PR5200 015G3	015	30	288	146	159	270	115	Ø8	<3.5
PR5200 018G3	18.5	37	288	146	159	270	115	Ø8	<3.5
PR5200 022G3	022	44	288	146	159	270	115	Ø8	<3.5
PR5200 030G3	030	60	288	146	159	270	115	Ø8	<3.5
PR5200 037G3	037	74	288	146	159	270	115	Ø8	<3.5
PR5200 045G3	045	90	288	146	159	270	115	Ø8	<3.5
PR5200 055G3	055	110	288	146	159	270	115	Ø8	<3.5

3-3-2. The rated power and rated current is max rated value of soft starter. Usually, matching the corresponding parameter of motor shall not be more than this value.

3-3-3. PR5200 series 75 kW-400 kW soft starter appearance and installation dimensions are shown in chart 3.2, the standard factory configuration is three input and six out.

Section III The Conditions of use and installation requirements

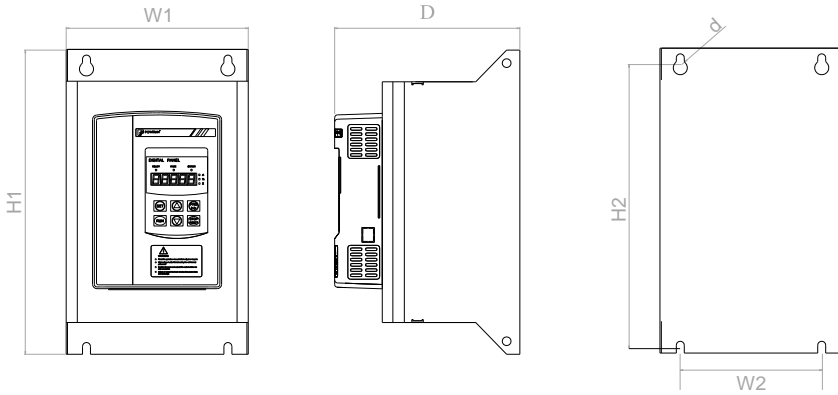

Rated Power (KW)	Rated Current (A)	Dimension			Installation			Net (kg)
		H1	W1	D	H2	W2	d	
075	150	350	206	210	330	160	09	<20
090	180	350	206	210	330	160	09	<20
115	230	350	206	210	330	160	09	<20
132	264	420	256	250	400	210	09	<23
160	320	420	256	250	400	210	09	<23
185	370	420	256	250	400	210	09	<23
200	400	420	256	250	400	210	09	<23
250	500	490	360	290	465	290	09	<31
280	560	490	360	290	465	290	09	<31
320	640	490	360	290	465	290	09	<31
400	800	490	360	290	465	290	09	<31

Section IV Main circuit and terminal wiring

★ PR5200 series soft starter has three kinds of wiring:

The main circuit wiring: three phase power input and output to the motor wiring and coil in line circuit breaker, bypass contactor wiring.

External terminal wiring: by 12 small terminals derivation, including input, output control lines and analog output signal lines.

Communication wiring: a standard RJ-45 network line socket and a DB9 socket which are used to connect computers or computer network

4-1. The basic wiring diagram of the soft starter

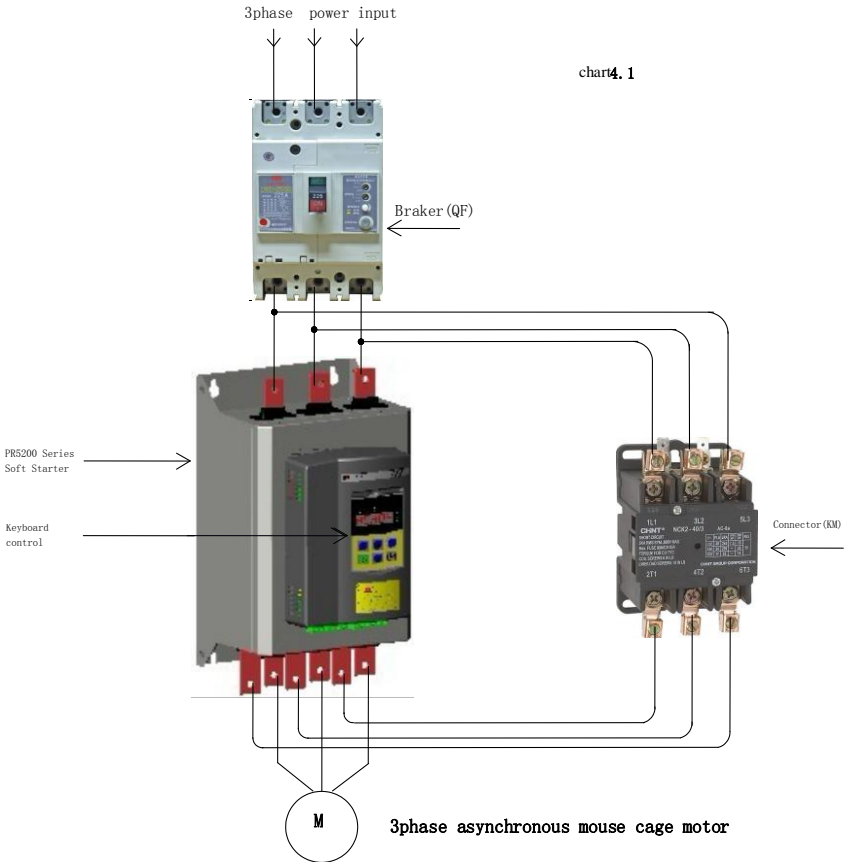

Note: six copper bar, below 3 for motor, upper 3 for contactor

4-2. Instruction of soft starter terminal wiring.

◆ Output terminal like chart 4.2 illustration :

图4. 2

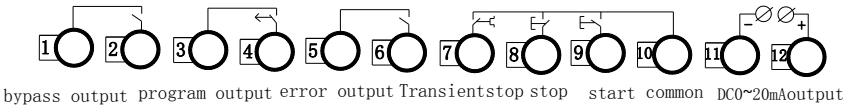

4-2-1. Terminal 1、 2 is bypass output which is used to control bypass contactor.

Normally open terminal will close. The terminal capacity is AC250V/5A.

4-2-2. Terminal 3、 4 is programmable relay output, output model and function set by “PJ” parameter. This terminal is normally open passive pot. Capacity is AC250V/5A.

4-2-3. Terminal 5、 6 is error output: which will close when soft starter error or power loss, Capacity is AC250V/5A.

4-2-4. Terminal 7 is transient stop input. This terminal must connect with Terminal 10 when soft starter normally work. If Terminal 7 disconnect with terminal 10, softstart will transient stop and show error. This terminal can be controlled by normal close output terminal of outside protection device, Set PC to 0 (primary protection), this terminal function is prohibited.

4-2-5. Terminal 8、 9、 10 is for wiring of outside control start, stop button. There are two type wiring way (3lines and 2 lines) To choose proper way according to demand. As chart 4.3.

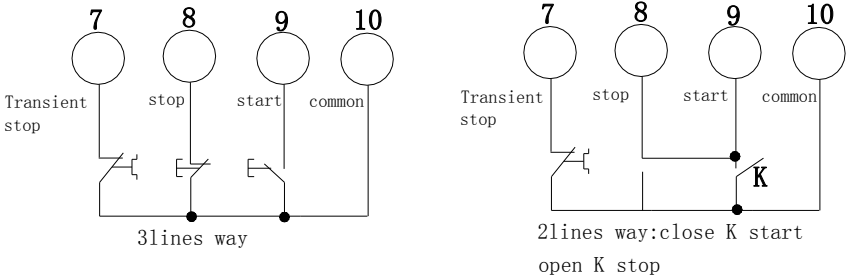

4-2-6. Terminal 11、 12 is 0~20mA DC analog output. Which is used to inspect the motor current. The max 20mA indicates motor current is 4 times of soft starter rated current. Which can be viewed by extra 0-20mA current meter. The max resistor of output load is 300Ω.

4-2-7. The outside terminal should be correct connection, otherwise which will damage this softstarter.

4-2-8. PR5200 series soft starter main circuit diagram.

Section IV

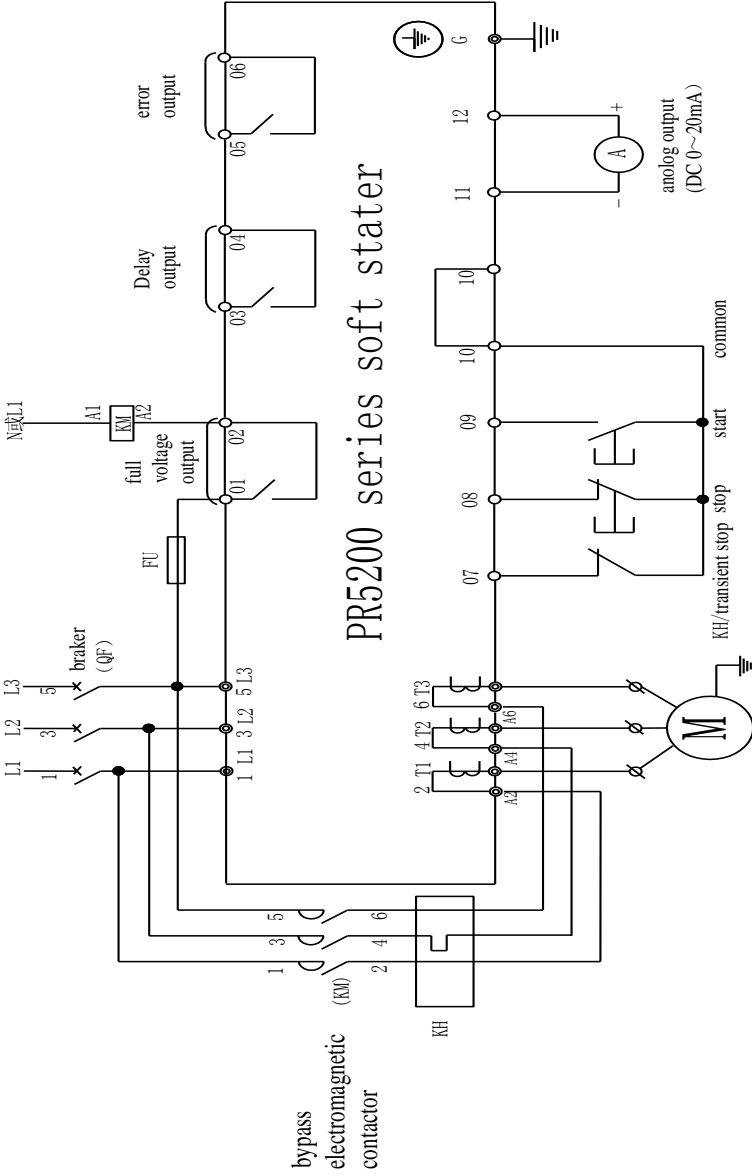

Section V Control panel and operation

★PR5200series soft starter has five kinds working state:ready,running,error,start and stop. Ready、 running、 error has corresponding state light.Startup indicates ××××, softstop indicates —×××,and ×××××indicates motor current.

5-1 Keyboard operational approach

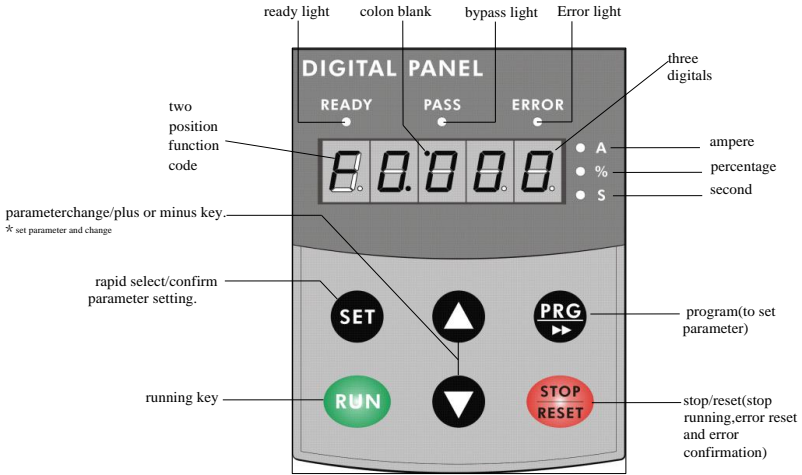

- 5-1-1. startup state: when the indication ready light display 5200 or READY,then softstater can start. The displaying 5200 means POWTRAN 5200 series softstarter. And ready means ready to start.
- 5-1-2. Delay state: ready or error state indication light flash means interval, display dE××× and count down means startup delay.
- 5-1-3. Start and stop key:in the process of soft startup,the screen display ×××× to indicates motor current, and only Stop key is valid, and can not enter menu to set parameter, and ready,running,error lights black out.In the process of soft stop, the screen display ×××× to indicates motor current,and only RUN key is valid, and can not enter menu to set parameter, and ready, running, error lights black out, Meanwhile the stop key has reset function.
- 5-1-4. PRG Key , in the non-help mode, press the PRG Key to enter the setup menu,display PX: XXX,then press PRG key again, colon flashes, that means can modify the parameters after colon.Press the Set key when the colon flashes, if the data has been modified, it will display good and twice ring, indicating that new data has been saved, and then exit. If you do not want to save the new data, press the PRG key, colon will stop flashing and restoring the original data, then press Set key or Stop key to exit.
- 5-1-5. Set Key, in the non-setting state, press the Set key to enter the Help menu,

display HX: XXX, press the Set key or Stop key to exit. In setting state, press the Set key to save the new setting of data and to exit the setting state.

- 5-1-6. Acceleration,deceleration key, in the setting menu, when the colon does not flash ,press the acceleration or deceleration key to change the function number; when colon flashes, press the acceleration or deceleration key to change the data, press on the acceleration or deceleration key for more than 1 second, the data will be increased or decreased continuously and quickly .In the help menu, press the acceleration or deceleration key to change the function number and the corresponding message.When the indicator light of bypass operation is on, and did not enter the setting and help menu, display AXXXX, that means the motor running current, then press the acceleration or deceleration key to select display PXXXX or HXXXX.PXXXX indicates motor apparent power;HXXXX indicates motor overloaded heat balance coefficient. When indication value of HXXXX is more than 100%,soft starter will be overload protection and display Err08.
- 5-1-7. When the data is more than 999, the last decimal point is bright, indicates the mantissa + 0.
- 5-1-8. If the key operating is effective,there will be a voice tip, or this key does not work in this state.
- 5-1-9. When the external control terminal connected to a 3-wire mode, the external control start button and stop button have the equivalent function with start and stop keys on the control panel.
- 5-1-10. The control panel with super anti-jamming design,and the outside connection distance is allow to be more than 3 m.
- 5-1-11.Keyboard digital display illustration

Display letter	relative letter	Display letter	relative letter	Display letter	relative letter
0	0	1	1	2	2
3	3	4	4	5	5
6	6	7	7	8	8
9	9 或 g	A	A 或 R	b	B
C	C	d	d 或 D	E	E
F	F	H	H	J	J
L	L	N	N	U	U 或 V
o	o	P	P	r	r
y	Y	RUN	RUN	UEr	Ver
rEAdy	READY	Good	good	_Err	Err

5-2 Function parameters setting and description

- Function parameters code in the following table

Code Setting Description				
Code	Name	Range of set value	Factory setting	Explanation
P0	Starting voltage	30-70%	30%	Voltage slope model is effective, the starting voltage of current mode is 40%.
P1	Soft starting time	2-60S	16S	Limiting current mode does not work.
P2	Soft stop time	0-60S	0S	Setting 0 means free stopping, please set 0 for one with two connections .
P3	Start delay	0-999S	0S	With a countdown delay, set to 0 without delay, starting immediately.
P4	Programming delay	0-999S	0S	For programmable relay output.
P5	Interval delay	0-999S	0S	Delay When overheated is released, indicator blinks to warn of the delay period.
P6	Starting to confine current	50-500%	280%	Limiting mode is effective, the maximum current limit value of Voltage slope model is 400%.
P7	Maximum operating current	50-200%	100%	Parameters input of P6, P7 is decided by P8 .
P8	Enter the display method	0-3	1	See note 5.5 Other Settings Description
P9	Under voltage protection	40-90%	80%	Protection when below the setted value .
PA	Overvoltage protection	100-140%	120%	Protection when higher than the set value

PB	Start mode	0-5	1	0 limit current, 1 voltage, 2 sudden sudden stop + limit current, 3 sudden stop + voltage, 4 current ramp, 5 pairs of closed-loop.
PC	Output protection allowed	0-4	4	0 Primary, 1 light load, 2 standard, 3 overloaded, 4 senior
PD	Operation control mode	0-7	0	Set 7 indicates banning starting or stopping operation , see note 5.5 other settings.
PE	Re-starting enable	0-13	0	See note 5.4 auto restart function.
PF	Parameters modified allowed	0-3	1	See note 5.5 Other settings.
PH	Communication address	0-64	0	For many sets of soft starter and PC computer communication
PJ	Programming output	0-19	7	See note 5.3 programmable relay output.
PL	Soft stop the current limit	20-100%	80%	See note 7.3.1 soft stop mode.
PP	Motor rated current		Rating	Used to input motor nominal is rated current
PU	Motor under load protection		Ban	See note 5.5 Other settings.
<p>Note, 1, The maximum current of P7 is based on PP calculated sustainable operation of the maximum current according to the light and heavy of the load, More than this value will do inverse time thermal protection.</p> <p>2, It will automatically exit the setting mode, if no key operation is more than 2 minutes during setting state.</p> <p>3, Can not set parameters in the soft start and soft stop process , but other states are no problem.</p> <p>4, Pressing the Set key (PRG) when is powered on, can set the parameters (PJ excluded) to restore the factory values.</p>				

5-3 Programmable relay output functions

There are two programmable relay output function, programmable timing output

Section V Control panel and operation

way and programmable state output way.

5-3-1. PJ set from 0 to 4 items (10 ~ 14), programmable output work is timing output way, the setting of output starting time as tabled below.

PJ setting value	0(10)	1(11)	2(12)	3(13)	4(14)
Programming output time	Initiate action command	Starting at the beginning	Bypass operation	Stop action command	Stopping is complete

5-3-1-1. This way of working contains a 999 seconds timer which is set by the setting item P4. If P4 is not 0, the start timing is according to the initial setting time set by PJ, when the time is up changing the output state, if P4 is 0, changing the output state immediately. The output of the reset time is to sustain 1 second after finishing the time delay set by P4 and in the state of readiness.

5-3-1-2. The control cycle of Programmable output timing is according to one starting process, if re-start the motor, the last programming output process is automatically stopped and re-started the programming process.

5-3-2. PJ is from 5 to 9 (15 ~ 19), the programmable output work is state output mode, the setting of the working state output as tabled below:

PJ set value	5(15)	6(16)	7(17)	8(18)	9(19)
state of output indication	Motor fault conditions	Running	Readiness	Start state	Bypass state

5-3-2-1 Programmable state output to indicate the working state of the soft starter, the time set by P4 is invalid in this mode. The factory setting of PJ is 7, which indicates the preparation state of soft starter, can start the motor in this state; programmable output is in the failure state, which indicates the fault of the motor (Err05, Err06, Err07, Err08, Err12, Err15), which is different from the function of ⑤, ⑥ fault output terminals; running state refers to non-preparation or fault condition, which includes 3 processes of start, bypass, soft-stop.

5-3-2-2 When PJ > 9, the reset state of the programmable output (③, ④ No. external pin) changed from normally open to closed, that is inverted output. Flexible using the function of programmable relay output, which can effectively simplify the external control logic circuit.

5-4 Automatic restart function

5-4-1. When setting PE from 1 to 9, it will allow the automatic restart function. This function is only valid for outside control line 2 way, and is not controlled by the outside allowed setting of PD. According to two-line wiring way and in the put off start state:

5-4-2. After power is on, delay of 60 seconds, then automatically start.

Section V

- 5-4-3. After stop, automatically restart after delaying 60 seconds, but if the time setting of P5 more than 60 seconds, the delay time is according to P5. During delay time the state indicator flashes.
- 5-4-4. The total automatically start times can be N, Including power-on start and restart after a failure. N is the setting value of PE. Auto-start mode must be again on electricity then take effective, and it is effective again after the power is on for every time.
- 5-4-5. When PE is set to 10, banned the function of losing electric protection. When the power is on, if the outside control terminal is in a closed state, then automatic starter motor, which means allows the electric start-up.
- 5-4-6. When PE is set to 11, it can re-start after failure: When the external control of instantaneous stop terminal (7) is not prohibited ($PC > 0$), or occurred the fault of instantaneous stop, overheating, overvoltage, under voltage and then recovery, can start the motor again without reset.
- 5-4-7. When PE is set to 12, banned the function of losing electric protection and restart after fault.
- 5-4-8. When PE is set to 13, running the function of memory recovery. During the running of bypass state, the power is off and then is on, the soft starter will auto-start recovery bypass operation.
- 5-4-9. Warning: The soft starter with the function of voltage-absent protection, when the power is off and then on, no matter the external control terminals in what position, it won't self-starting, so as to avoid injuries. But when the automatic restart function allows, banned the function of losing electric protection, allowing the memory running resume function, the function of losing electric protection will fail!

5-5 Other settings Description

5-5-1 P8 set used to select input and display the way, as followed table:

P8 set value	0	1	2	3
P6, P7 input	Current value	Percentage	Current value	Percentage
Operation display	Current value	Current value	Percentage	Percentage

When the input mode of P6, P7 as a percentage, it is indicates the percentage of motor current value setted by PP.

5-5-2 PD used to select the motor start control mode, as followed table:

Value	0	1	2	3	4	5	6	7
Keyboard	1	1	0	0	1	1	0	0
External control	0	1	1	1	1	0	0	0
Communicate	0	0	0	1	1	1	1	0

- (1) In table 1 indicates allowed, 0 indicates prohibited. For example, if the accident is not allowed to stop after starting, or not allow accidental starting during the maintain-ance, you can set it to 7, then ban all the operation of

starting and stopping

- (2) When the external control allows, the external control terminal ⑧, ⑩ must be connected by a normally closed switch or shorted , or can not start the motor.

5-5-3 PF is the selection of allowing to modify parameter, there are three options:

- (1) PF is setted to 0, it is prohibited to modify any parameter in addition to PF.
- (2) PF is setted to 1, it is prohibited to modify P4, P7, P8, PE, PH, PJ, PL, PU parameters.
- (3) PF is setted to 2, it is allowed to modify all the parameters.

5-5-4 PU is used to set the motor under load protection.

5-5-4-1 $PU < 10$, the motor under load protection is prohibited.

5-5-4-2 The range of low load current protection is 10% to 90% of the motor rated current, it is decided by the ten digits of PU.

5-5-4-3 The delay time of low load is ranging from 5 to 90 seconds, it is setted by 10 times of PU digit. If the PU digit is 0, the protection operation delays 5 seconds. For example, $PU = 42$, indicates the low load current is 40% , the delay time of protection action is 20 seconds.

5-6 .Help and instructions

- Help information as following table:

Display	Explanation
AC: XXX	Three digital voltmeter, to monitor three-phase AC power supply voltage.
022-3	the specifications of soft starter is 22KW-380/50Hz
H1: E05	last occurred fault information Err05.
H2: E01	There had been a fault information Err01.
H3: E06	There had been a fault information Err06.
H9: E00	There was no fault information.
Uer3.0	the software version of this product is Ver3.0. With the software upgrade, version with the increase.
LXXXX	Total number of successful starting.
RUNXX	The spending time (seconds) of last soft starting (starting successfully) .
Note: H1 ~ H9 with recursive way to storage newly happened nine fault information.	

- (1) In the non-soft start and non-soft stop state, and did not enter the setting mode, press the Set key, can enter the Help menu, and then press the acceleration or deceleration key to select message.
- (2) In the help state, press the Set key or Stop button to exit help state.

Section VI Protection and description

PR5200 series soft starter with complete protection to protect the safety of soft starter and motor. During the application, appropriate protection parameters and level should be setted based on different situation.

6-1 Protection functions and their parameters

- 6-1-1. Soft starter over-temperature protection: the temperature rose to $80\text{ }^{\circ}\text{C} \pm 5\text{ }^{\circ}\text{C}$ over-temperature protection, when the temperature dropped to $55\text{ }^{\circ}\text{C}$ (the lowest), no over-temperature protection.
- 6-1-2. Input phase protection lag time : <3 seconds.
- 6-1-3. Three-phase unbalance protection lag time: <3 seconds.
- 6-1-4. Three-phase unbalance protection lag time: <3 seconds.It is based on the deviation of all phase current greater than $50\% \pm 10\%$. When the load current is lower than 30% of the nominal rating of soft starter, the benchmark deviation will increase.
- 6-1-5. Starting time of over current protection: continuous 5 times greater than the maximum operating current of the protection time setted by P7 in Table 6.1.
- 6-1-6. Time of running overload protection, it is based on the maximum operating current of P7 and doing the inverse thermal protection, trip protection time curve shows on Chart 6.1.
- 6-1-7. The protection lag time of much too low supply voltage, when the power supply voltage is lower than the 40% of limit, the protection time <0.5 seconds, or the protection time <3 seconds if it is lower than the setting value.
- 6-1-8. The protection lag time of much too high supply voltage : when the power supply voltage is lower than the 140% of limit, the protection time <0.5 seconds, or the protection time <3 seconds if it is higher than the setting value.
- 6-1-9. The protection delay time of load short-circuit : <0.1 seconds, the current is 10 times more than soft starter nominal rated current. This protection can not replace fuse short-circuit protection device.
- 6-1-10. Motor under load protection, the current range is 10% to 90% of motor rated current, the protection action delay from 5 to 90 seconds.

These time parameters are from tested effective signal to a tripping protection instructions, and the parameters just for reference. All the protection functions of

PR5200 series soft starter can be verified through the actual or simulation method. If it can't meet the user's requirements, special protection device should be added to ensure safety.

6-2 Protection level setting description

6-2-1. In order to adapt to different applications, PR5200 series soft starter has five protection level, there are 0: primary, 1: light load, 2: Standard 3: heavy, 4: Advanced, it settled by PC setting. Among them,

6-2-1-1. Primary protection is against to the function of external terminal instantaneous stop, meanwhile only remains the overheating, short circuit and main circuit fault protection, it can be applied to needed emergency start in unconditional occasion, such as fire systems, etc.

6-2-1-2. The three protection level of light load, standard load and overload have the complete protection function. The difference is the time curves of motor overloaded thermal protection are not the same. The time parameters of motor thermal protection are as Table 6.1 and Chart 6.1.

6-2-1-3. High level of protection standards is stringent at start. Other protection features parameters keep the same with standard protection set.

6-2-2. Protection level and thermal protection time according to PC setting is as the diagram below:

Diagram 6.1

PC setting	0(Primary)	1(Light load)			2(standard)			3(heavy load)			4(high grade)			Description
Running overload Level of protection	no	2 level			10 level			20 level			10 level			According to IEC60947-4-2 Standard
Start over-current Protection time	no	3 seconds			15 seconds			30 seconds			15 seconds			Starting current for more than F7setting 5times calculation
Overload trip time running list	Current multiple (I/Ie)	3	4	5	3	4	5	3	4	5	3	4	5	Typical values for the table
	Trip time (seconds)	4.5	2.3	1.5	23	12	7.5	46	23	15	23	12	7.5	

Setting item PP should be according to the value of motor rated input current, Otherwise, when the setting item P6, P7 as a percentage of the input mode (Set by the setting item P8)Starting current and protect the current will be with high deviation.

The motor current set by item PP can not be less than 20% of the soft starter nominal current. When the motor current set by PP is small, tripping action for protecting the sensitivity of the error will increase.

6-2-3. According to IEC60947-4-2 standard curve of the motor thermal protection

tripping time is as follows:

Chart 6.1

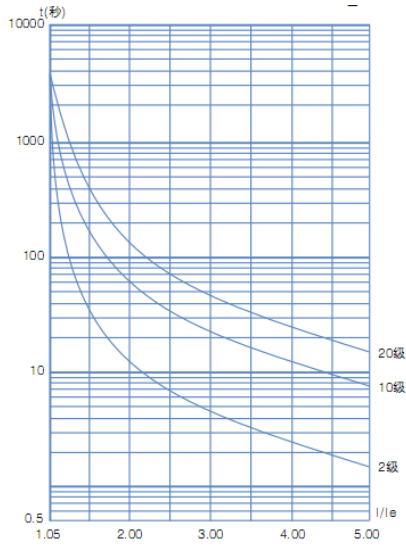

Protection tripping time curve (thermal state)

Section VII Test running and application

- ★ Double-check before power running according to the following terms:
 - Whether the soft starter power match with the motor rated power.
 - Whether the motor insulation satisfy the requirements.
 - Whether the Input and output main circuit wiring is correct.
 - Whether all the terminal screws are tightened.

7-1. Power test running

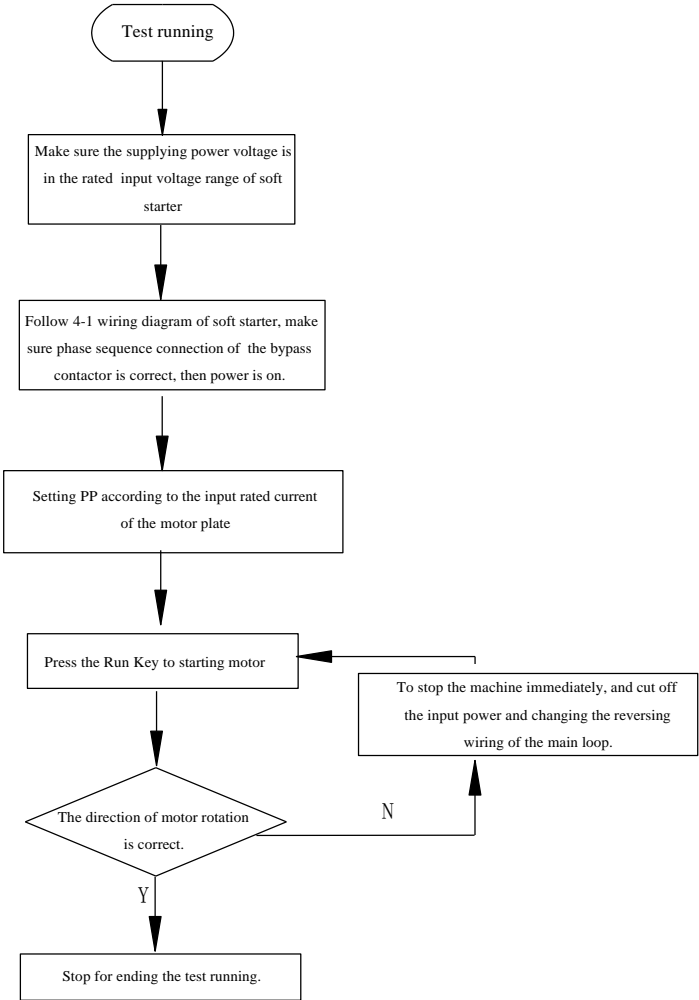

- 7-1-1. If the motor starter status is not satisfactory, Refer to 7.2 of the soft starter starting mode and application to select appropriate starting model.
- 7-1-2. If the motor starting torque is not enough, you can change the starting voltage (voltage mode) or current-limiting value (current mode), to improve the motor starting torque.
- 7-1-3. When soft starter power on, do not open the cover, to avoid electric shock.
- 7-1-4. In the power test of running, if appearing unusual phenomena, such as abnormal noise, smoke or odor, etc., should be quickly cut off the power and make further investigation.
- 7-1-5. If power on or when starting, appearing failure light and display ErrXX, you can find the reason according to the displayed fault code and the corresponding chapter of the cause. Press the stop button or external stop button to reset the fault status.

★ Note:

- (1) When the ambient temperature is below $-10\text{ }^{\circ}\text{C}$, should power on for more than 30 minutes to warm-up before starting.
- (2) When the soft starter drive the motor successfully, the operation status indicator on the middle panel lights, that proves the bypass is in running status. If at this time, the motor stop by bypass contactor without actuation, you should check the bypass contactor and associated wiring connection.

7-2. PR5200 Series soft starter starting mode and application

PR5200 series soft starter has six models to suit a variety of complex starter motor and load conditions, the user can choose it as different application.

7-2-1 Current limit starting mode

When setting PB to 0, Set the start mode for this mode.

Chart 7.1 shows the current limit mode of the motor starting current waveform changes. I_1 is starting current limit by setting, when the motor starts, the output voltage rapidly increases, Till the motor

current reaches the current limit value I_1 , and maintain the motor current is not higher than this value, then gradually as the output voltage increased, gradually accelerate the motor, when the motor reaches the rated speed, the bypass contactor make actuation, output current rapidly dropped to or below the motor rated current I_e , starting process is complete.

When the motor is lightly loaded or seting the current limit highly, the maximum starting current may not reach the set limit value is normal.

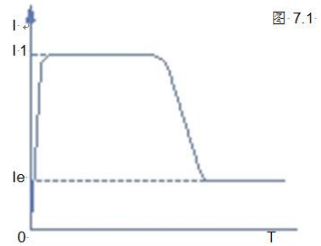

Current limit starting mode is generally used for a strictly limited starting current requirements of the occasion.

7-2-2 Voltage ramp start model

When PB setting item is 1, Start mode is for this mode.

Chart 7.2 shows the output voltage waveform as voltage ramp start voltage waveform. U 1 is the initial starting voltage of starting, when the motor start, the motor current does not exceed 400% of

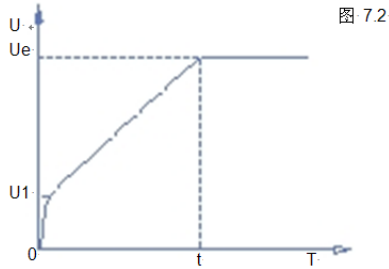

rated range, the output voltage of soft starter quickly rise to U1, then the output voltage gradually increase by the start parameters setting, the motor is in smooth acceleration according to voltage continuously rise, when the voltage reach the rated voltage Ue, the rated motor speed, bypass contactor act, starting process is complete.

Starting time t is based on standard load obtained in the standard experimental conditions, control parameters, PR5200 series soft starter is based on this parameter benchmark, by controlling the output voltage, make the motor speed up in a smooth start-up process, not a mechanical control, regardless of time t. Acceleration is smooth. In view of this, when the load is light, set the start time often less than the starting time, as long as a smooth start is normal.

In general, the voltage ramp start mode is suit to not strict starting current requirement and strict demanding of a smooth start of the occasion.

7-2-3 Kickstart mode

PB setting item set to 2 or 3, starter model is for this mode.

Chart 7.3 and Chart 7.4 shows the kickstart mode waveform of the output. In some heavy load situations, due to mechanical effects of static friction, when it can not start the motor, you can use this start mode. At the start, imposing a high fixed voltage to the motor first and last for a limited period of time, to

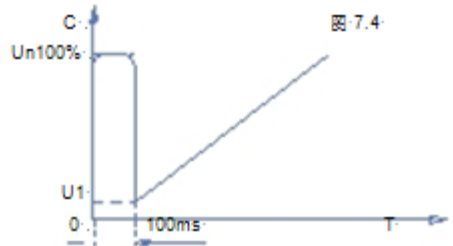
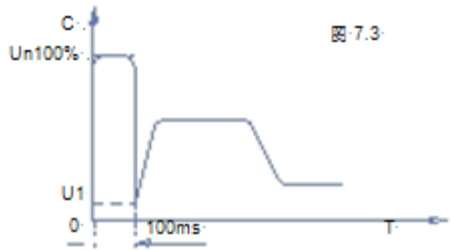

Section VII

Before using this model, start motor with non-sudden jump model, if the motor can not move due to static friction, then use this model; otherwise avoid to start this mode to reduce the unnecessary high current impact.

7-2-4 Current ramp start mode

PB items set 4, start mode is for this mode.

Chart 7.5 shows the Current Ramp start mode output current waveform, which I_1 is the current limit set P6, T_1 value is the time set by P1.

Current ramp start mode has a strong acceleration ability, for bipolar motors, can also shorten the start-up time within a certain range.

7-2-5 The voltage limiting double loop start mode

PB Set PB as 5 to set start mode for this mode.

Double loop starting voltage limiting mode adopt voltage ramp and current limit dual closed-loop control model, is both stable requires and strict current limiting demanding, the integrated starter-limiting mode, it uses the prediction algorithm to estimate the work status of the motor.

In this start mode, output voltage waveform will be based on the motor and load conditions vary.

7-3. PR5200 series soft starter's stop mode and application

PR5200 series soft starters, there are two stop modes, soft-stop mode and free stop mode.

7-3-1 Soft stop mode

When Setting item P2 is not zero, set the stop mode for this mode.

In this stop mode, the motor power start from the bypass contactor and switch to the output of soft starter thyristor, soft starter output voltage decrease steadily from the total pressure, reducing the motor speed steady in order to avoid mechanical shock, till the motor stops running. Soft stop output cut-off voltage equal to the initial voltage of starting.

Soft stop mode can reduce and eliminate the surge of pump type load.

Soft stop mode can use setting item PL to set the soft stop current limit, in soft stop, reduce the impact of high current, pay attention that, this soft start current limit is a percentage calculated on the basis of starting current limit value.

7-3-2 Free stop mode

Item P2 is set to 0, set stop mode for this mode.

In this stop mode, when the soft starter receive the stop command, immediately disconnect the bypass contactor and ban soft starter thyristors voltage output, motor gradually stop as load inertia. In the situation of one drive two(more) wiring, should set soft starter stop mode as this, in order to avoid of the phase fault reporting when

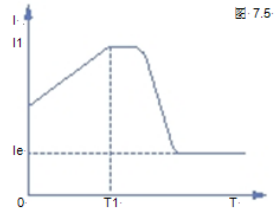

output switching.

Under normal circumstances, if not necessary soft stop, stop mode should be free stop model, to extend the life of the soft starter.

As stop model completely ban the instantaneous output, can avoid an instantaneous high-current impact in special applications.

7-4. Special application

7-4-1 .Motors in parallel Start:

If not exceed the rated power limit of the soft starter, the motor can be connected in parallel (motors sum current can not exceed the power of soft starter, the type selected depending on the application rated current), but at this time should provide additional thermal protection devices for each motor.

7-4-2 Two-speed motor start:

PR5200 series soft starter can start with two-speed motor, before changing from low speed to high speed, must be solved by delayed magnetic period, to avoid a very large reverse current between the line and the motor.

7-4-3 Long cable:

As the resistance of the cable causes, a very long motor cables could cause voltage landing, if the voltage drop is very obvious, it will affect the current consumption and starting torque, when choosing motor and soft starter, must consider this.

7-4-4 soft starters paralleled with the same one power line:

If in a power line, installed several soft starters, should install the input reactor between the wiring of the soft starter and transformer, to the middle of the line should be . Reactor should be installed between each feeder circuit breaker and soft starter.

7-4-5 Surge Protection Device (SPD) application:

In the applications which may suffer from lightning or other causes that lead to overvoltage, overcurrent, surge interference, should consider installing a surge protector, detailed application methods instructions, refer to POWTRAN company "surge protector (SPD)" Product Sample or other relevant data.

7-5. Application examples

Under different load conditions, parameter settings for example shown in Table 7.2. Data in the table is only for reference, should be adjusted according to actual situation

Table 7.2

Type of load	Start time (seconds)	The initial voltage	Voltage starting (maximum current limit)	Limit Start
Ball	30	60%	4	4.5

Section VII

Fans	26	30%	4	3.5
Centrifugal pump	16	40%	4	2.5
Piston compressor	16	40%	4	3
Enhance the mechanical	16	60%	4	3.5
Mixer	16	50%	4	3
Crusher	16	50%	4	3.5
Screw compressor	16	40%	4	3
Screw conveyor	20	40%	4	2
Light load motor	16	30%	4	3
Belt conveyors	20	40%	4	2.5
Heat pump	16	40%	4	3

Section VIII RS485 communication

POWTRAN PR5200 series soft starters through the built-in RS485 standard interface can be connected with the personal computer and PLC for serial communication.

Controlled by the host command to run the soft starter / stop, monitor the operational status of the soft starter and modify its function data, etc.

This communication details, please refer to RS485 operating instructions.

Soft starter can be used for RS485 communications for remote operation by computer, run the command input, run the state administration, more than one soft starter function code data one time input to achieve such a write function code input effort.

8-1. Main functions:

- A. Running stop command input .
- B. Health monitoring.
- C. Real-time tracking (the table shows operating information).
- D. Function code to one time read, write, save to the documentation.
- E. Communications software, please separate agreement with the our company.

Section IX Fault causes and treatment

Fault codes and treatment as following table:

Display	Description	Problems and treatment methods
Err00	Failure has been solved	Just happened undervoltage, overvoltage or overheating, instantaneous stop terminals are open, such failures, now has been normal, this time to prepare lights, reset to start the motor.
Err01	External terminal momentary Open circuit	Short-circuit connection with the external Instantaneous stop terminal⑦and public terminal ⑩, or connecting to other protective devices normally closed contact.
Err02	Soft starter overheating	Start too often or the motor power do not match with the soft starter.
Err03	Starting times too longer than 60 seconds	Starting parameter settings is inadequate or the load is too heavy, the power capacity is not enough, etc.
Err04	Input phase lost	Check the input or main circuit failure, whether the bypass contactor is stuck in the closed position and whether the SCR is in open circuit and so on.
Err05	Output phase lost	Check the input or main circuit failure, whether the bypass contactor is stuck in the closed position and whether the SCR is in open circuit and so on.
Err06	Three-phase unbalanced	Check whther the input three-phase power supply and the load motor is normal.
Err07	Start over-current	Whether the load is too heavy or motor power does not match with soft starter.
Err08	Running overload protection	Whether the load is too heavy or setting items P7, PP parameters set incorrectly.
Err09	Supply voltage is too low	Check the input voltage or setting item P9 parameter set incorrectly.
Err10	Supply voltage is too high	Check the input voltage or setting item PA parameter set incorrectly.
Err11	Set the parameters error	Modify the settings, or pressing the Enter key on power to restore the factory values.
Err12	Load short-circuit	Check whether overloading or thyristor short circuit.
Err13	Automatic re-start wiring error	Check whether the outside the control start and stop terminal is connected to 2-wire mode.

Err14	External Stop terminal wiring error	When you allow external control mode, the external control stop terminal is in the open state, which can not start the motor.
Err15	Motor underload	Check the motor shaft and load faults.
<p>Note: Some fault phenomena are interrelated, as the report Err02, may be related with soft starter overheating or load short current, so when checking fails, consideration should be comprehensive, accurately determine the point of failure.</p>		

Section X Soft-start model specifications and options

10-1 PR5200 Series soft starter (5.5KW-55KW) list of the external parts of the specification reference:

Soft starter model	Rated Power (KW)	Rated current (A)	Supporting circuit breaker model (QF)	Supporting the bypass contactor model supporting the bypass contactor type (KM)	A line size	Remarks
PR5200 5R5G3	5.5	11	CM1-63L/16	CJ20-25	2.5mm ² Cable	55KW and below, the wiring for the three-in & six-out, usually in the bypass contactor circuit, do not require heating or motor protection devices, have line protection. Rated power and rated current is the maximum rating of the soft starter.
PR5200 7R5G3	7.5	15	CM1-63L/20	CJ20-25	4mm ² Cable	
PR5200 011G3	011	22	CM1-63L/32	CJ20-40	6mm ² Cable	
PR5200 015G3	015	30	CM1-63L/40	CJ20-63	10mm ² Cable	
PR5200 018G3	018	37	CM1-63L/50	CJ20-63	10mm ² Cable	
PR5200 022G3	022	44	CM1-63L/63	CJ20-63	16mm ² Cable	
PR5200 030G3	030	60	CM1-63L/80	CJ20-100	25mm ² Cable	
PR5200 037G3	037	74	CM1-63L/100	CJ20-160	35mm ² Cable	
PR5200 045-3	045	90	CM1-63L/125	CJ20-160	35mm ² Cable	
PR5200 055G3	055	110	CM1-63L/160	CJ20-160	35mm ² Cable	

10-2 PR5200 Series soft starter (75KW-400KW) list of external accessories specifications reference:

Soft starter model	Rated Power (KW)	Rated current (A)	Supporting circuit breaker model (QF)	Supporting the bypass contactor model supporting the bypass contactor type (KM)	A line size	Remarks
PR5200 075G3	075	150	CM1-225L/180	CJ20-250	30*3mm ² Cable	75KW and below, the wiring for the three-in & six-out, when the bypass contactor is closed position with line protection, no need external motor protection device. Rated power and rated current is the maximum rating of the soft starter, matching circuit breaker and the bypass contactor should match the size of motor specification.
PR5200 090G3	090	180	CM1-225L/225	CJ20-250	30*3mm ² Cable	
PR5200 115G3	115	230	CM1-225L/315	CJ20-400	30*3mm ² Cable	
PR5200 132G3	132	260	CM1-400L/315	CJ20-400	30*4mm ² Cable	
PR5200 160G3	160	320	CM1-400L/350	CJ20-630	30*4mm ² Cable	
PR5200 185G3	185	370	CM1-400L/400	CJ20-630	40*4mm ² Cable	
PR5200 200G3	200	400	CM1-400L/500	CJ20-630	40*4mm ² Cable	
PR5200 250G3	250	500	CM1-630L/630	CJ20-630	40*4mm ² Cable	
PR5200 280G3	280	560	CM1-630L/630	CJ29-1000A	40*4mm ² Cable	
PR5200 320G3	320	640	CM1-630L/700	CJ29-1000A	40*4mm ² Cable	
PR5200 400G3	400	800	CW1-1000/3	CJ29-1000A	40*4mm ² Cable	

Section XI Quality Assurance

This product quality assurance is in accordance with the following provisions :

1. Indeed the responsibility of the manufacturer, quality assurance details:
 - 1-1. When used in the China (to the date of shipment)
 - ※ Within one month after shipping, refund, replacement,
 - ※ Within three months after shipment, replacement, repair.
 - ※ Within 15 months after delivery, repair.
 - 1-2. Export to overseas (excluding domestic), the ship within six months after purchase, be responsible for repair.
2. No matter when and where, use of our brand's products, enjoy the paid services for all life.
3. The Company's sales throughout the country, production, all agents can provide service to this product, their service conditions:
 - 3-1 Location of the unit to "3" inspection services (including troubleshooting).
 - 3-2 Be in accordance with these companies and distribution agents in relation to service, the contract responsibility standards.
 - 3-3 Can be paid to the general mass of the distribution agent, the request for after-sales service (whether or not the warranty).
4. Quality of the product or products appear responsible for the accident, up to 1-1 or 1-2 terms only assume the responsibility, if you need more liability guarantee, prior to your own property insurance in insurance companies.
5. This product is warranted for one year from the date of shipment.
6. In the case of the following causes of failure, even during the warranty period is also a paid repair:
 - 6-1 Incorrect operation (according to manual date), or caused by modified without permission to repair the problems.
 - 6-2 Beyond the standard specification requires, problems caused by the use of the the soft starter.
 - 6-3 After purchasing, loss or damage caused by improper handling.
 - 6-4 The device poor or failure caused by environmental aging.
 - 6-5 Due to earthquake, fire, wind and flood damage, lightning, abnormal voltage or accompanied by other natural disasters damage.
 - 6-6 Damage during transport (Note: The mode of transport specified by the client . Our company assist on behalf of the procedures for transfer of goods).
 - 6-7 Manufacturer's brand label, trademark, serial number, nameplate and other damaged or unreadable.
 - 6-8 Purchase agreement is not paid in money.
 - 6-9 For installation, wiring, operation, maintenance or other use of objective reality can not be described to the Company's service units.
7. For refund, replacement, repair services, goods shall be returned to the company, confirmed the attribution of responsibility, before be returned or repair

POWTRAN Technology Product Warranty Card

Thank you very much for purchasing POWTRAN product.

The product has passed the strict quality inspection by POWTRAN technology. According to the guarantee card, in the warranty period, if the product has quality problem caused by the hardware malfunction during the normal using condition, the company will be responsible for free maintenance.

Product type:	Producing number:
Warranty Period:	
Purchasing date:	_____ Day _____ Month _____ Year
Invoice No.:	
Customer Name: (Or Company Name)	
Address:	
Postcode:	Tel: Fax:
Dealers Name:	
Address:	
Postcode:	Tel: Fax:
Dealers Seal	

Customer feedback form of soft starter fault

Dear customer: In order to provide our best service to you ,please fill in the table below

Application		Motor	KW	pole type	
When happens	Continuous operation Acceleration slow down power supply others ()				
What displays	Alarm display () with or without keyboard display () output voltage (YES NO)				
Running after rest	Yes No	Resetting way	Keyboard Panel	Terminal Power	
The control terminal	Others()				
Working hours		frequency		Installation place	
Whether the power is off	Yes No	Whether the machine is abnormal	YES No	Whether it has fault before	Yes(Times) No



The following table is filled in by service agencies

Maintenance Record:

The first time	Maintenance Agency Name		Tel	
	Address		Postcode	
	Maintenance bill number		Maintenance staff sign	
The second time	Maintenance Agency Name		Tel	
	Address		Postcode	
	Maintenance bill number		Maintenance staff sign	
The third time	Maintenance Agency Name		Tel	
	Address		Postcode	
	Maintenance bill number		Maintenance staff sign	



Product information feedback

Dear users:

Thank you for your attention and purchasing POWTRAN technology products! In order to serve you better, we hope to get your personal general information about using POWTRAN technology products, your now and future demand on POWTRAN technology products, gain for your valuable feedback. To facilitate as early as possible when you need our services, please visit the company website POWTRAN technology [Http://www.powtran.com](http://www.powtran.com) "technologies and services" and "Downloads" section for information feedback.

- 1) Download and update you product manual
- 2) Access to products, technical information, such as instructions, size characteristics, and frequently asked questions
- 3) Application Case Share.
- 4) Technical consulting, on-line feedback
- 5) Feedback by the form of e-mail on product information and user needs information
- 6) For the latest products, access to all kinds of additional services and extended warran