



**N. MICRO**

**S.A.R.L.**

Meeting & Serving the needs of OEMs in Lebanon & the region since 1996.

# Introduction of our Company:

- *We are distributors of electronic components, power supply units, industrial & home automation, electrical panels, PV & UPS systems, batteries...*
- *We provide complete turnkey solutions and maintenance for Industrial automated control systems, Photovoltaic backup and remote power systems.*
- *We design, program and prototype electronic circuits*

# Employees

- ◎ Our team consists of 12 employees:
- ◎ General manager, Sales manager, two HR & Accounting, three Engineers, Stock manager, two drivers for deliveries, one outside sales and two loaders.

# Our Branches



Beirut, Dora Branch



Zahle Beqaa Branch



Beirut Mar Michael Branch

# SOME OF OUR BRANDS



- Power Supplies, Battery chargers, Backup systems
- LED Power supplies.



MICROCHIP

- Microcontrollers.



- Industrial sensors and switches.



- Terminal blocks, connectors.



- Relays.



- Far infrared heaters.



- Programmable Logic Controllers
- Variable frequency drives



- UPS backup systems
- Solar variable frequency drives



- Electronics development tools.



- Home Automation.



- Batteries.





# High Reliability Standard Switching Power Supply

— one stop shopping for all the power you need —

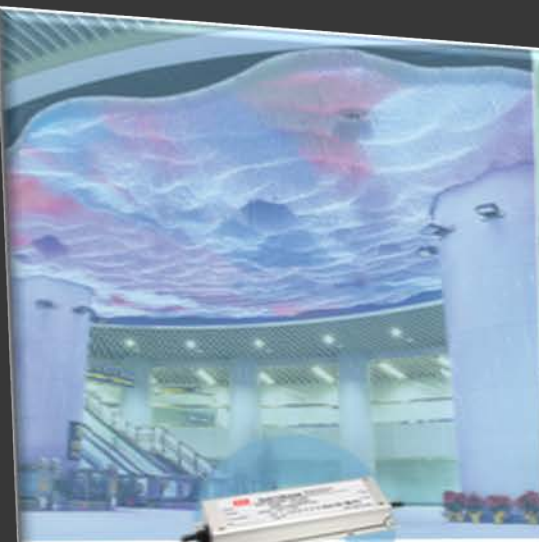

LED Power Solution



Medical Power Solution



High Bay Lighting  
Power Solution



LED Display Power  
Solution



Green Energy Power  
Solution



Burn-in Equipments  
Power Solution

Power solution  
High bay lighting

Solution  
LED Display Power

Solution  
Green Energy Power

Power solution  
burn-in equipments



# Drive Solutions

LSIS offers drive solutions that can achieve reduction in energy consumption significantly.



Low Voltage VFD



Medium Voltage VFD



Softstarter



PLC



Remote I/O



HMI



Servo Drive & Motor  
(XGT Servo System)





**66m<sup>2</sup> to 216m<sup>2</sup>**  
Different heating area but equivalent warmth and satisfaction

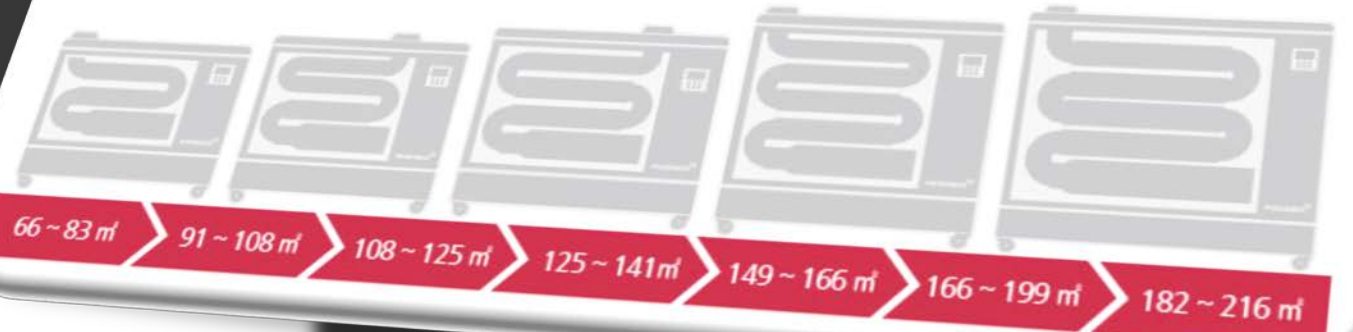

Far Infrared Rays Heater AH-600

**Heating Capacity 16~19 kW/h**



Convenient High/Low Fire Flame adjustment



Blocking Residual Fuel in a Very Short Time  
No Soot & Reduced Bad Smell



Highly Efficient Silencer System



Luxurious soft touch buttons & sophisticated design



Convenient Off-timer Function Every 30minutes for 24hours



Convenient Remote Controller Digital control



Durable, strong lockable casters

AIRREX<sup>®</sup>





# Professional Pumping Systems

# DUKSHIN



<b>MANUAL</b> 	<b>BATTERY</b> 	<b>DRUM</b> 	<b>CHEMICAL</b> 
<b>ELECTRIC</b>  12-24V DC	<b>WATER</b> 	<b>ACCESSORIES</b> 	<b>OTHERS</b> 





### Relays

- Signal Relay
- Latching Relay
- Industrial Relay
- Hermetically Sealed Relay
- Power Relay
- Automotive Relay
- Relay Socket
- Relay Socket

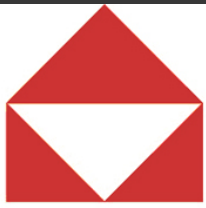

**DEGSON**®

Terminal Blocks & Precise Moulds  
ISO9001 ISO14001 ISO80079-34  
UL US Ex CE ENEC CQC ROHS REACH

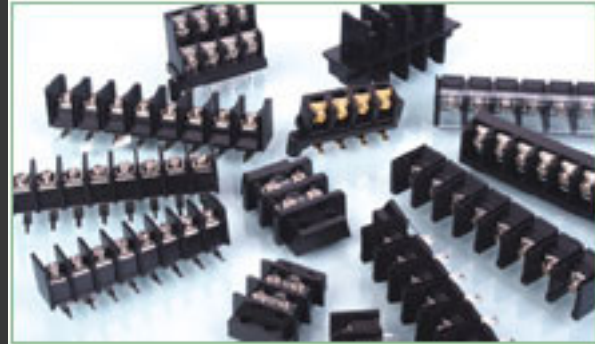
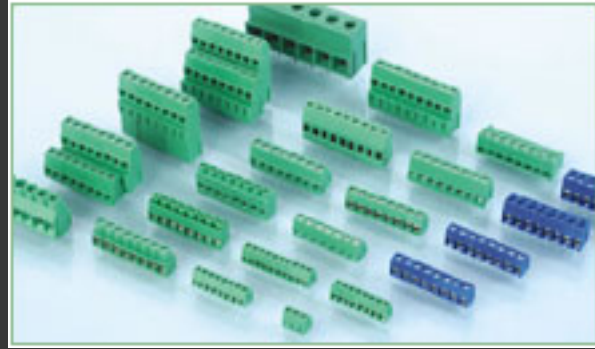



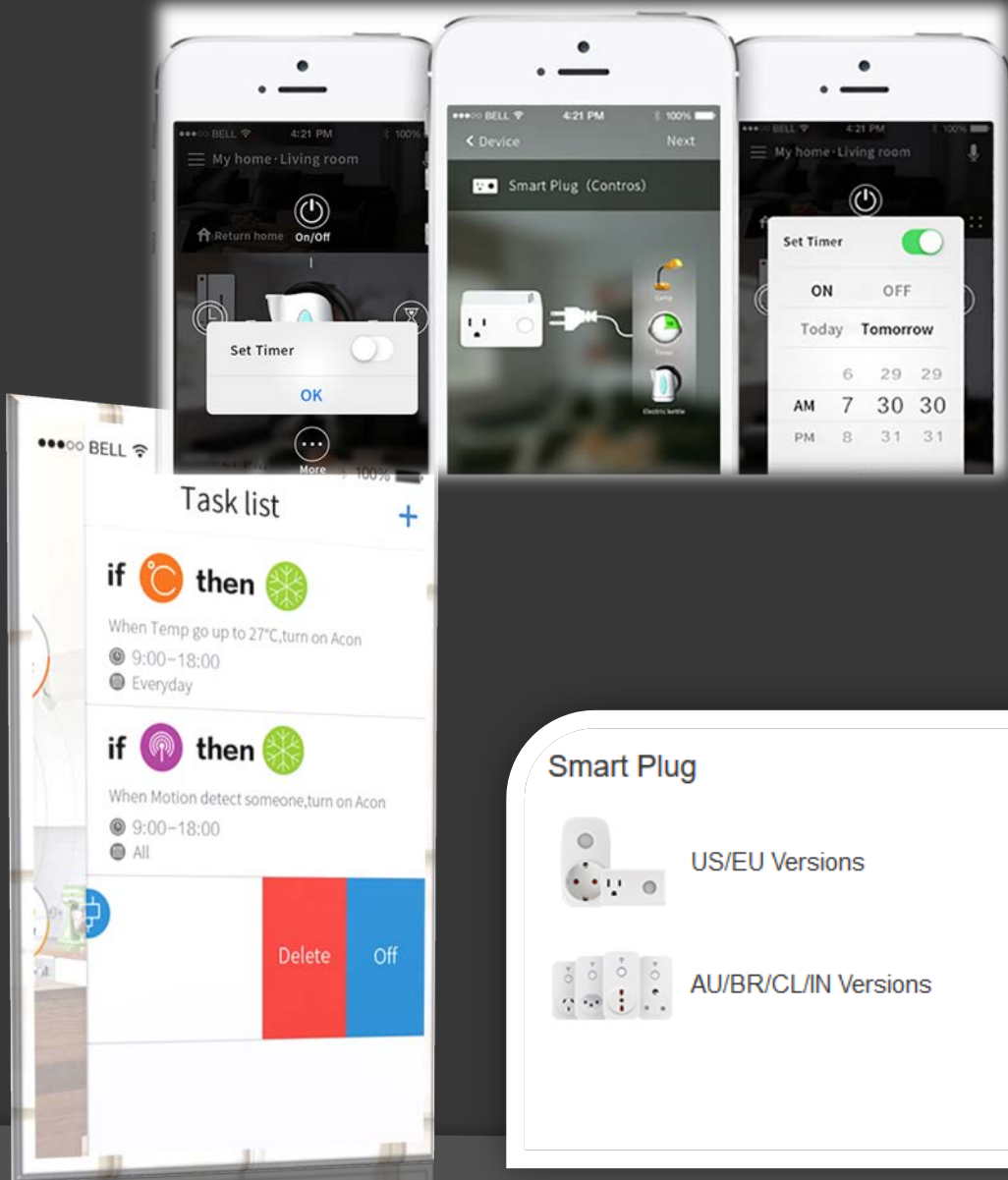

# Smart Universal Remote Control

One button to control all appliances (TV, Air-conditioning, Motor Curtain, etc.)

Wi-Fi universal remote | RM Pro



## Smart Plug



US/EU Versions



AU/BR/CL/IN Versions

## Universal Remote



IR Control



IR+RF Control



RM pro 433MHz

## Sensors



Alarm Kit



Environment Sensor

## Light Switch



US/EU/UK Versions



杜亚 DOOYA™  
TUBULAR MOTOR

GLOBAL LEADING  
MANUFACTURER OF  
SMART HOME SYSTEM  
AND WINDOW & DOOR  
AUTOMATION



# AC TUBULAR MOTOR

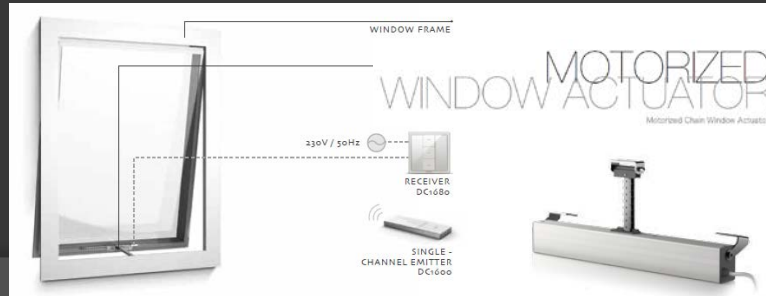
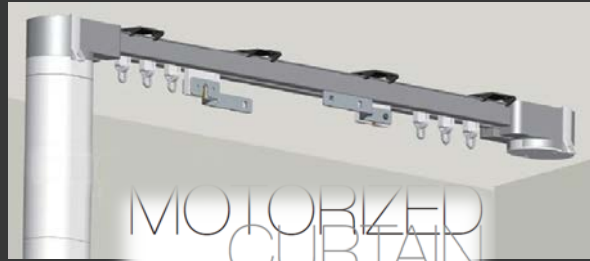

# MOTORIZED PROJECTION SCREEN

Motorized Projection Screen Motor



# MOTORIZED CURTAIN

Hand Lightly Start Motorized Curtain

# MOTORIZED SHEER BLINDS

Motorized Sheer Blinds

# MOTORIZED VENETIAN BLINDS

Multi Motorized Venetian Blinds in-One-line Management System

# MOTORIZED CEILING CURTAIN

ESS Motorized Canopy

# MOTORIZED WINDOW ACTUATOR

Motorized Chain Window Actuator

# MOTORIZED INSECT SCREEN

Motorized Screen Door

# MOTORIZED WOOD SHUTTER

Built-in Motorized Wood Shutter Motor

# MOTORIZED ROLLER DOOR

Motorized Roller Door

# MOTORIZED ROLLER BLINDS

Line Management For Silent Motorized Roller Blinds

# DOUBLE-GLAZED VENETIAN BLINDS

Sliding Door Double-Glazed Aluminum Venetian Blinds

# MOTORIZED AWNING

Motorized Awning With Led Light



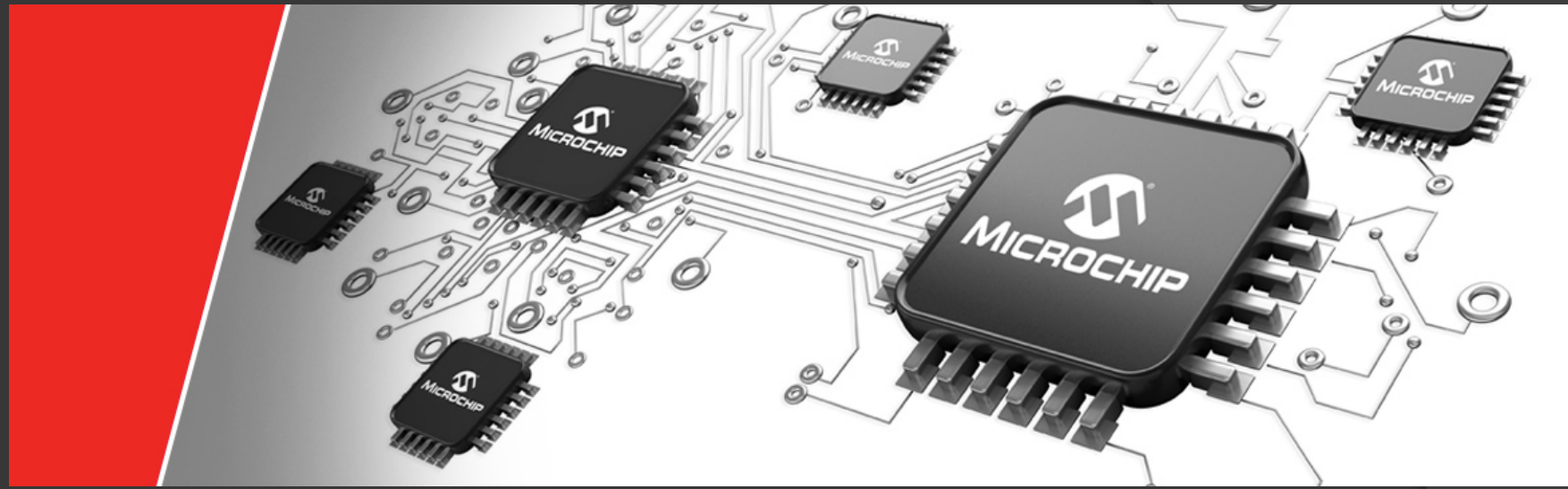

**Microchip microcontrollers,  
development kits and peripheral ICs.**



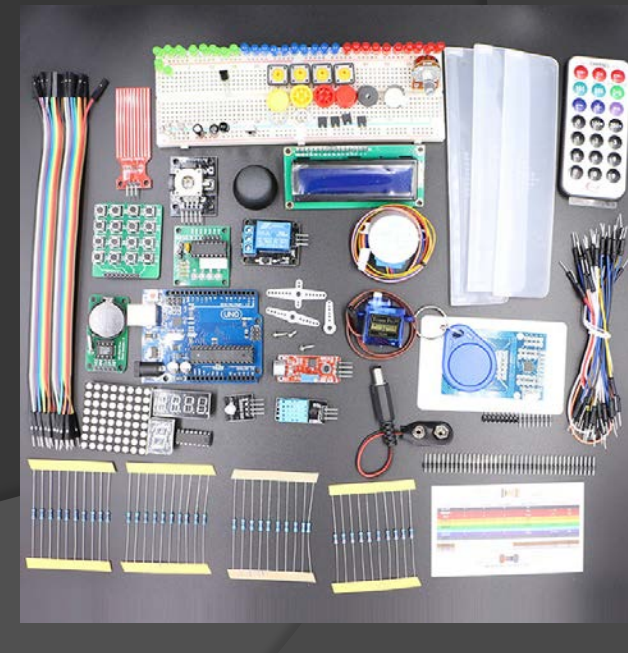
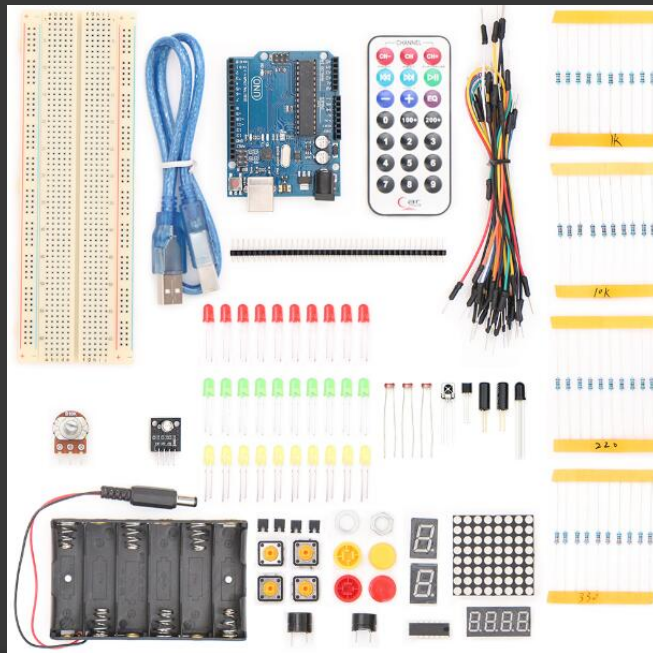
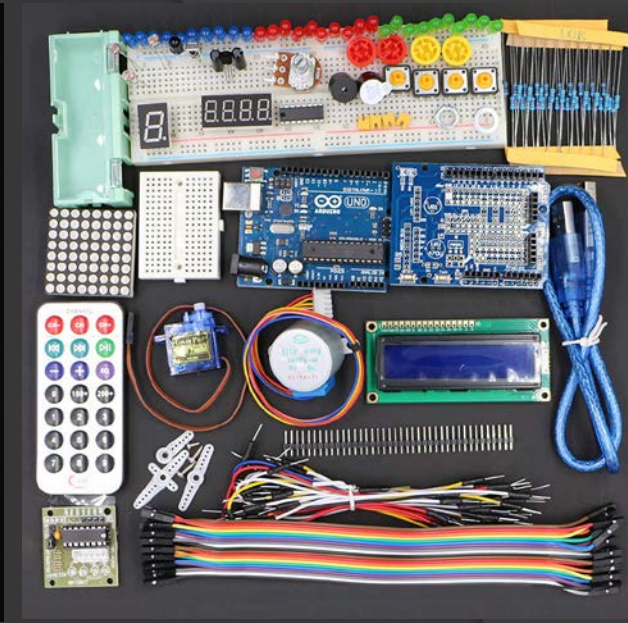
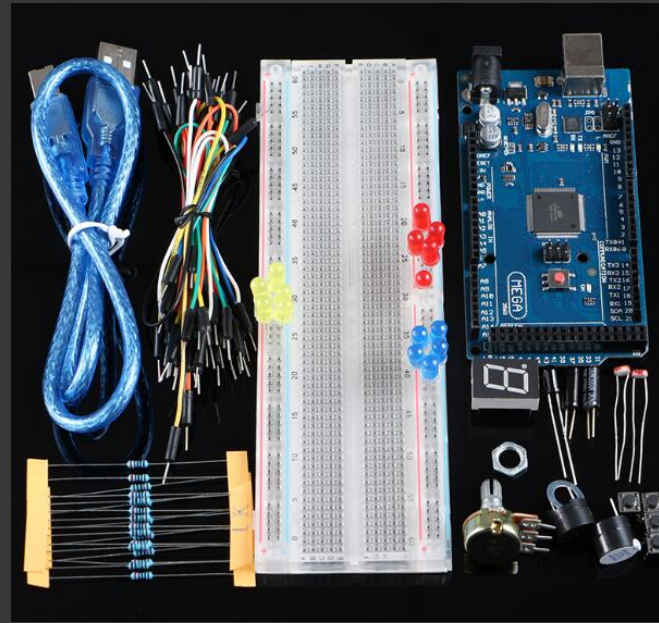
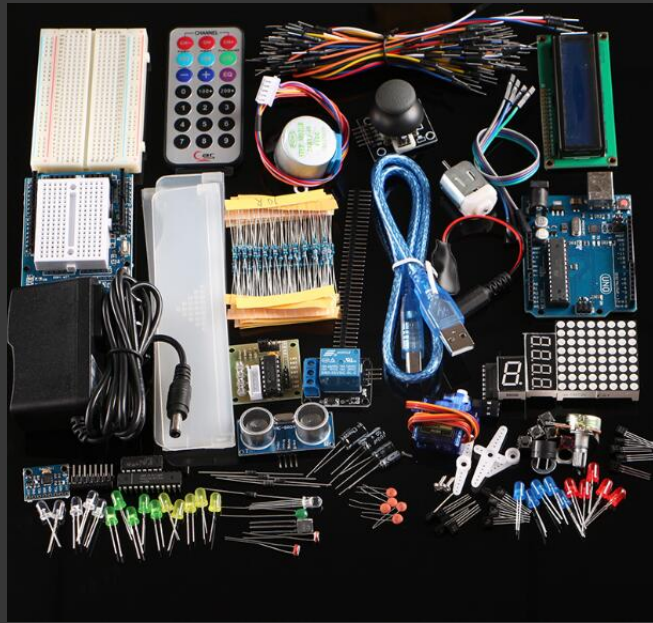

# Online sinewave UPS

Internal battery & External battery long backup time models



**1 – 3KVA    6 – 20KVA**



**10 – 40KVA 3 Phase**

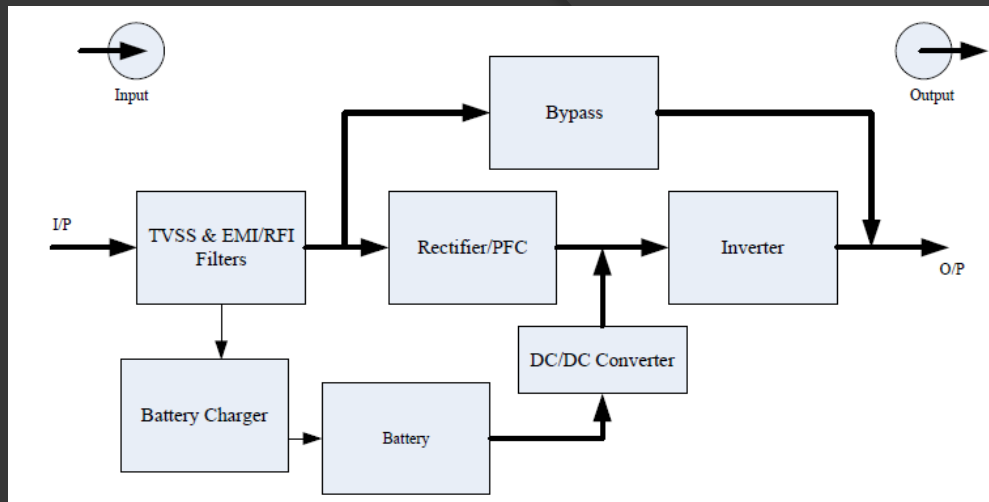

**60 – 500KVA 3 Phase**



# Line interactive sinewave UPS



600VA

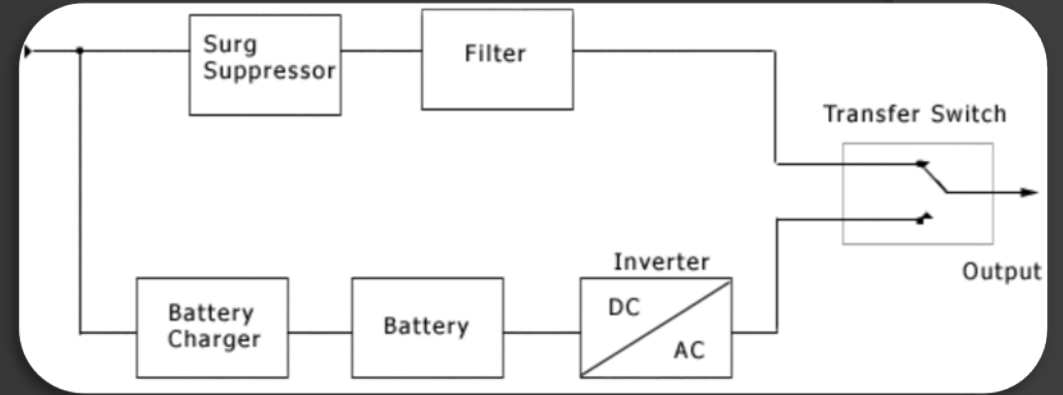

# Hybrid solar UPS



**1 – 5KVA + parallel up to 30KVA single phase or 3 phase**

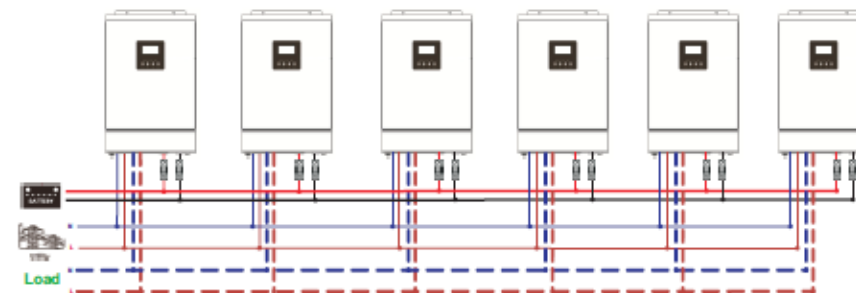

Two inverters in each phase:

Power Connection

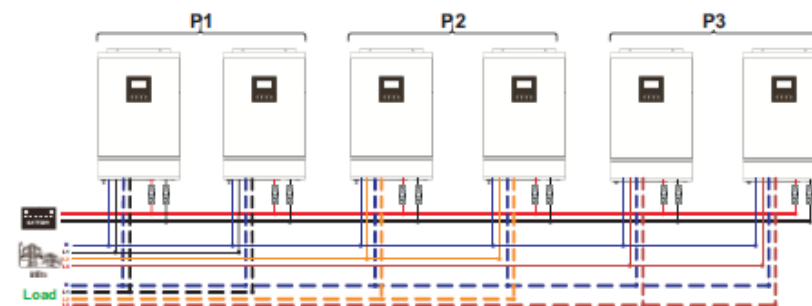

Three inverters in one phase, two inverters in second phase and one inverter for the third phase:

Power Connection

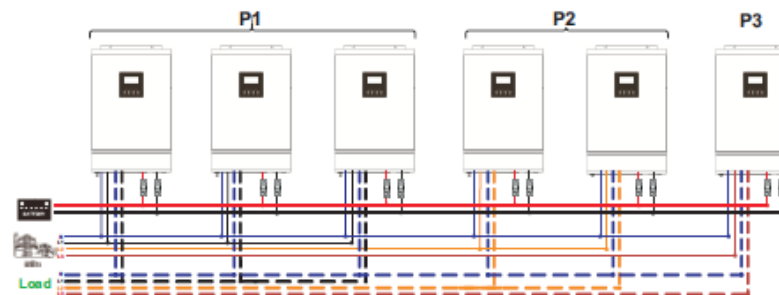

# ON GRID SOLAR INVERTER

## SAJ

### LIGHTWEIGHT

100% aluminum case  
superior heat dissipation  
25% size reduction  
20.5kg minimum weight

### ROBUSTNESS

150-1000V wide range input  
10 years+@60°C DC bus capacitor lifetime

### SIMPLICITY

Easy-plug input & output interface  
4 optional communication interfaces  
(RS485/GRPS/Wi-Fi/Ethernet)

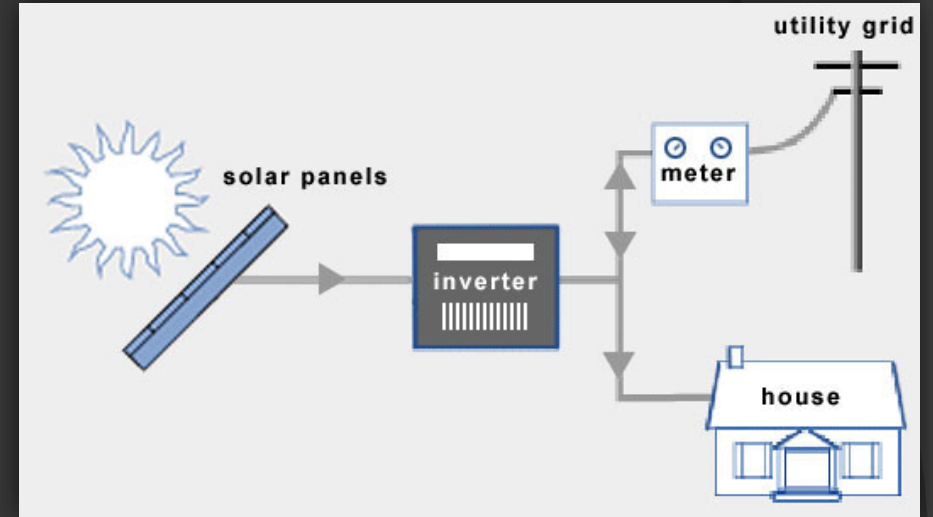

1KVA to 50KVA



Sununo Plus 1K/1.5K/2K/2.5K/3K/3.6K; Sununo Plus 3K-M/4K-M/5K-M/6K-M; Suntrio Plus 4K/5K/6K/8K/10K



Suntrio Plus 12K/15K/17K/20K/25K/33K/40K/50K



# Solar Panels and accessories







# POWTRAN

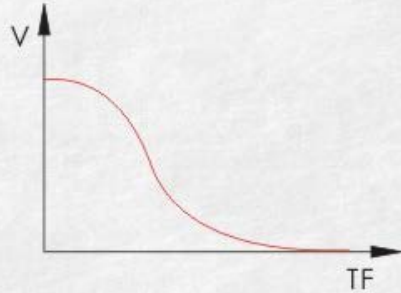

## Soft stop function

Soft stop function efficiently solve the stop of inertial systems.

Surge problem: It can not be realized by traditional starting device.A

## PR5200 series

### High-quality Soft starter



**PR5200** series soft starter, with the newest motor control theory and proprietary motor protection technology, it's an alternative products of old star delta conversion, auto-induction voltage-reduced starting and Excitation step-down device.



## Multi-Mode Start

6 kinds of special start model: To suit complicated motor and load situation.

# Braking resistors

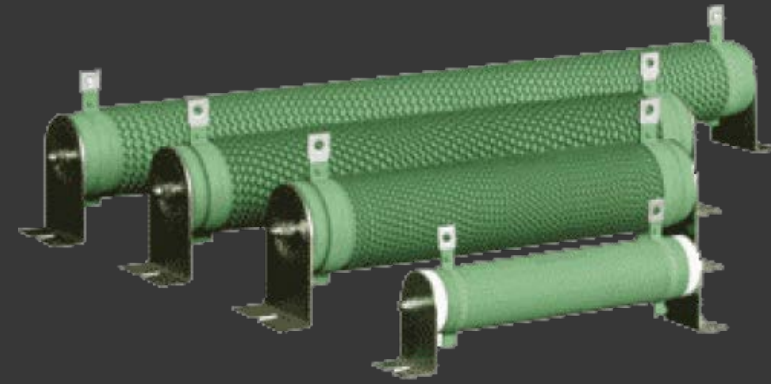

# Primary Batteries

# maxell



Silver Oxide

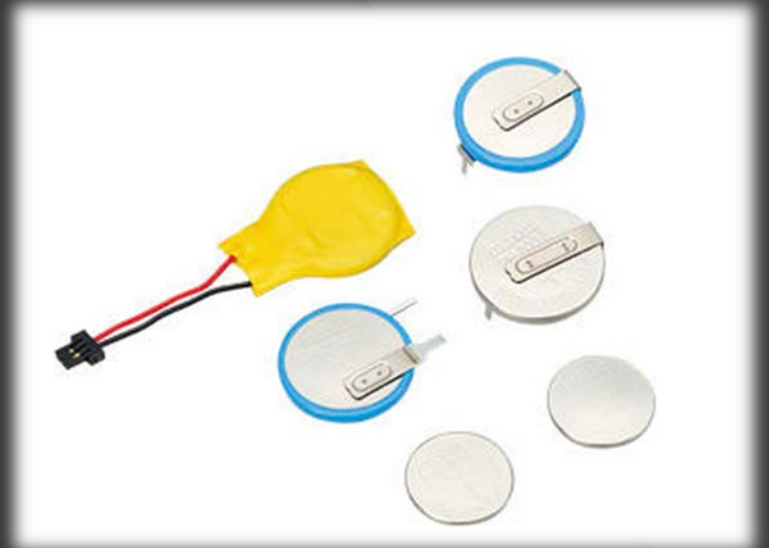

Lithium

## GoldenPower®



Alkaline

## EEMB®



# Rechargeable Batteries



Flooded lead acid deep-cycle



Ni-MH Ni-Cd



Li-ion  
Li-Polymer



Sealed lead acid deep-cycle





# Panel Enclosures

**B&J**<sup>®</sup>



# Switches

MHao®



# Diptronics

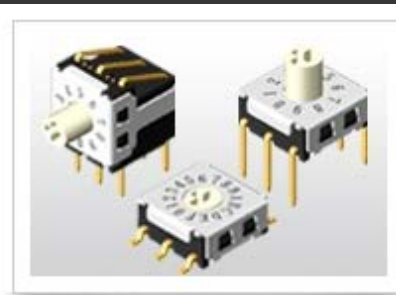
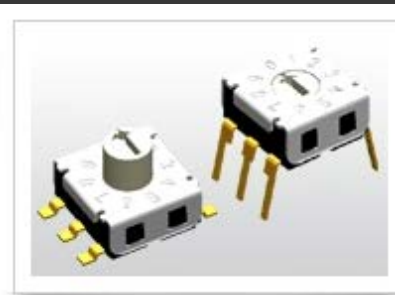
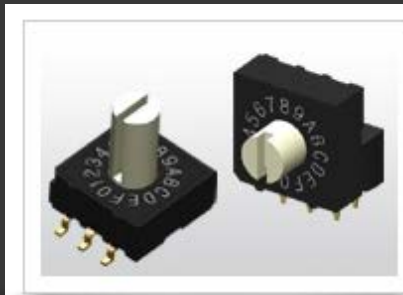
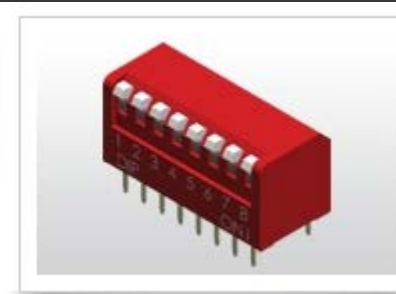
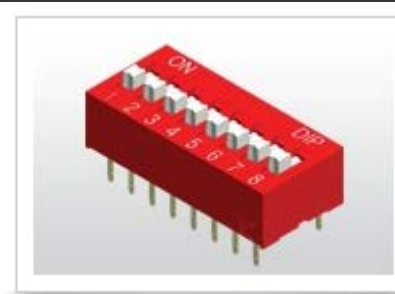
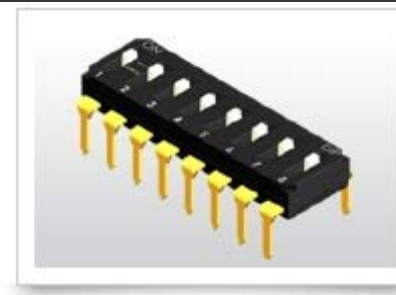
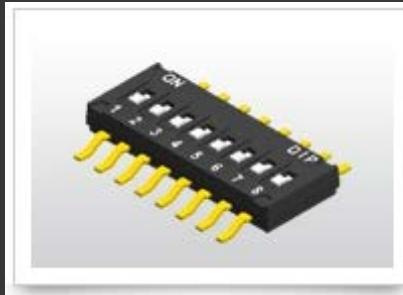
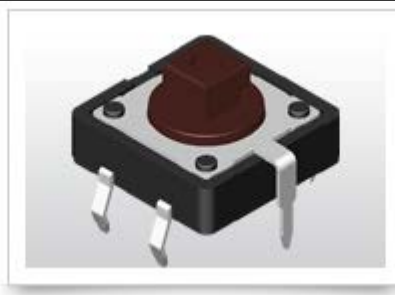

# Universal Programmers





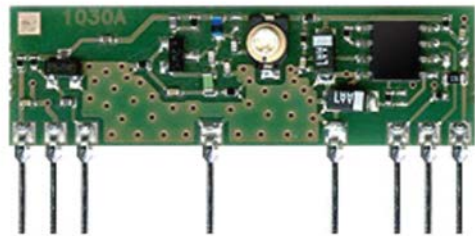

- ✓ Modulation: ASK (AM)
- ✓ Supply: 5V
- ✓ Frequency: 433.92 MHz
- ✓ Sensitivity: -106 dBm
- ✓ Consumption: 2.5 mA
- ✓ Dimension: 38.1 x 12.3 x 3 mm



- ✓ Modulation: ASK (AM)
- ✓ Supply: 3V
- ✓ Frequency: 433.92 MHz
- ✓ Sensitivity: -100 dBm
- ✓ Consumption: 0.07 mA
- ✓ Dimension: 40.1 x 17.5 x 5.5 mm

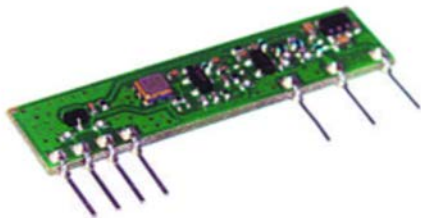

- ✓ Modulation: ASK (AM)
- ✓ Supply: 3 ÷ 12V
- ✓ Frequency: 433.92 MHz
- ✓ Consumption: 7.5 mA
- ✓ ERP Power: 10 mW
- ✓ Dimension: 38.1 x 11 x 3 mm



- ✓ Modulation: ASK (AM)
- ✓ Supply: 3V
- ✓ Frequency: 433.92 MHz
- ✓ Consumption: 25 mA
- ✓ ERP Power: 10 mW
- ✓ Dimension: 56 x 18.5 x 8 mm



- ✓ Modulation: FSK (FM) PLL
- ✓ Supply: 3V
- ✓ Frequency: 433.92 MHz
- ✓ Consumption: 14 mA
- ✓ ERP Power: 10 mW
- ✓ Dimension: 25.4 x 12.4 x 2.5 mm

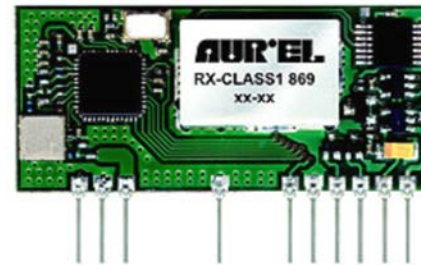

- ✓ Superheterodyne
- ✓ Modulation: FSK (FM)
- ✓ Supply: 3÷5.5 V
- ✓ Frequency: 869.2125 / 869.2375 MHz
- ✓ Sensitivity: -115 dBm
- ✓ Consumption: 40 mA
- ✓ Dimension: 45.7 x 20 x 3.5 mm

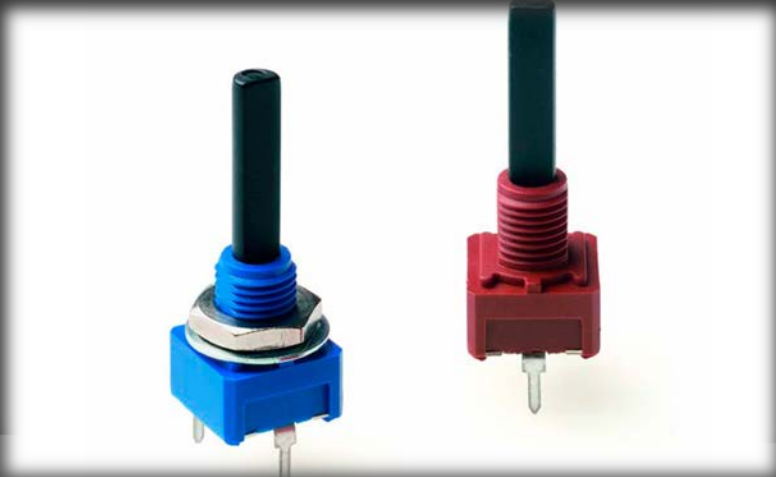
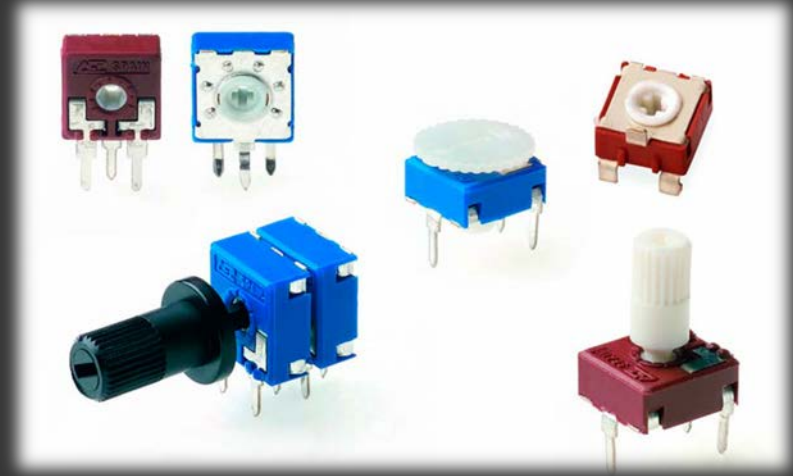
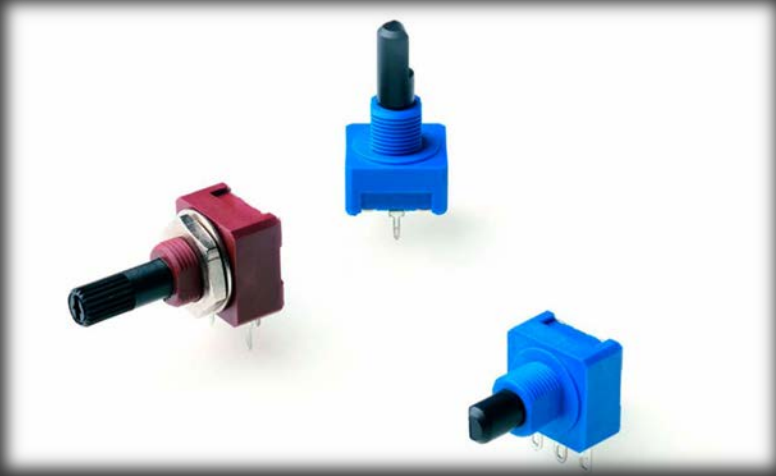
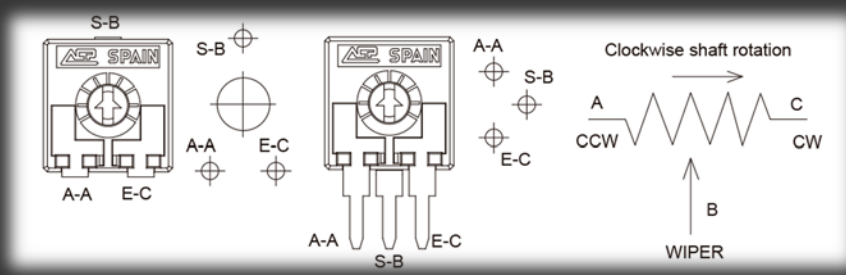



# Programmable Relays







# DC and AC Fans





杰美康机电  
JUST MOTION CONTROL

## Digital stepper driver and motor

Digital Driver with built-in micro technology, much improve smooth and noise from the low subdivision .

Integrating automatic parameter tuning function inside.

Can adjust the optimal operation parameters automatically for different motors to maximize the performance of the motor.







SHENMAO Technology Inc.

▪ SMT Assembly

- ☐ Tin Lead Solder Paste
- ☐ Lead-Free Solder Paste
- ☐ Water Soluble Solder Paste
- ☐ Package on Package Solder Paste
- ☐ Low Temperature Solder Paste
- ☐ Halogen Free Solder Paste
- ☐ Adhesive

▪ Wave Solder Assembly

- ☐ Solder Bar
- ☐ Cored Solder Wire
- ☐ Lead Free Solder Wire
- ☐ Halogens Free Solder Wire







### Applications:

#### Monorail / Electric Chain Hoist:



SAGA1-L4



SAGA1-L6



SAGA1-L8



SAGA1-L6B



SAGA1-L8B



SAGA1-L10,  
L10-1

#### Tower Crane:



SAGA1-10,  
L10-1



SAGA1-K1,K2



SAGA1-K3,K4



SAGA1-L12,  
L12-1



SAGA1-L40

#### Overhead Crane:



SAGA1-L8B



SAGA1-L10,  
L10-1



SAGA1-L12,  
L12-1



SAGA1-K1,K2



SAGA1-K3,K4



SAGA1-L40

#### Tow Truck:



SAGA1-L4  
(DC TYPE)



SAGA1-L6  
(DC TYPE)



SAGA1-L8  
(DC TYPE)



SAGA1-V6  
(DC TYPE)

#### Concrete Mixer:



SAGA1-L4  
(DC TYPE)



SAGA1-L6  
(DC TYPE)



SAGA1-L8  
(DC TYPE)



SAGA1-V6  
(DC TYPE)

#### Lifting Equipment:



SAGA1-L4  
(DC TYPE)



SAGA1-L6  
(DC TYPE)



SAGA1-L8  
(DC TYPE)



SAGA1-V6  
(DC TYPE)



Flow Sensors



30/50/70mm Multi-Layer Light Tower



Pressure Sensors



Ultrasonic Level Transmitter Rotating Paddle Level Switches



Capacitive Proximity Sensors



22/25/30mm Control Switches



Vibrating Fork Level Switches





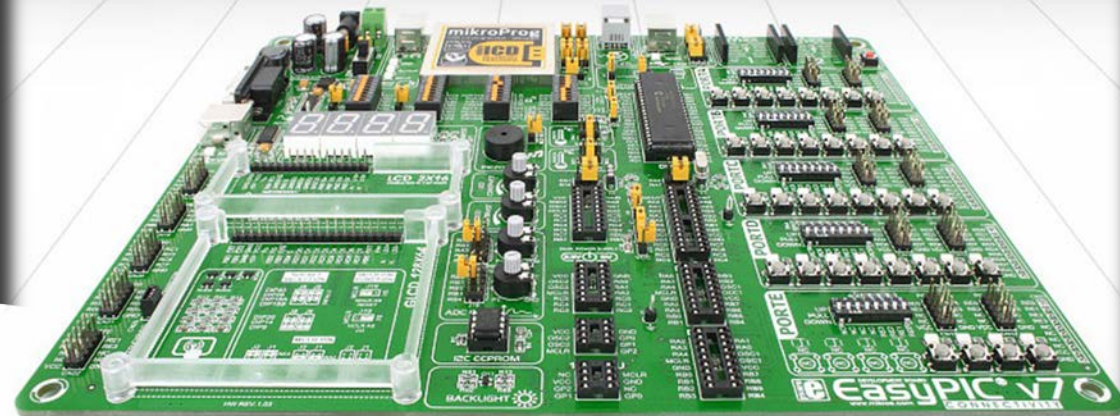

## Add-On Boards

We have an arsenal of accessory boards for almost everything you need. If you have a development system, we provide the easiest way to expand it's functionality in many segments. Add wireless communication, real-time clocks, storage interface, displays, measurement sensors, audio signalization, and much more with our accessory boards. We offer Proto boards, IDC10 header compatible boards and Click Boards™ built for mikroBUS™ pinout standard.



Click Boards (257)

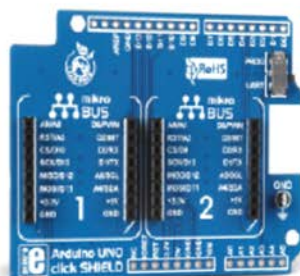

click shields (12)

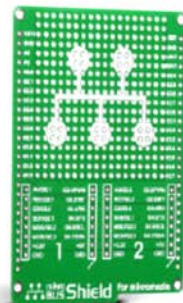

mikromedia shields (8)

wikromedia shields (8)



# Some of our projects:



Cement Factory Control Panel & Automation with Billing & Remote Access

# WEIGHING AND PACKING MACHINE CONTROL PANEL WIRING AND PLC PROGRAMMING





# WEIGHING AND PACKING MACHINE:

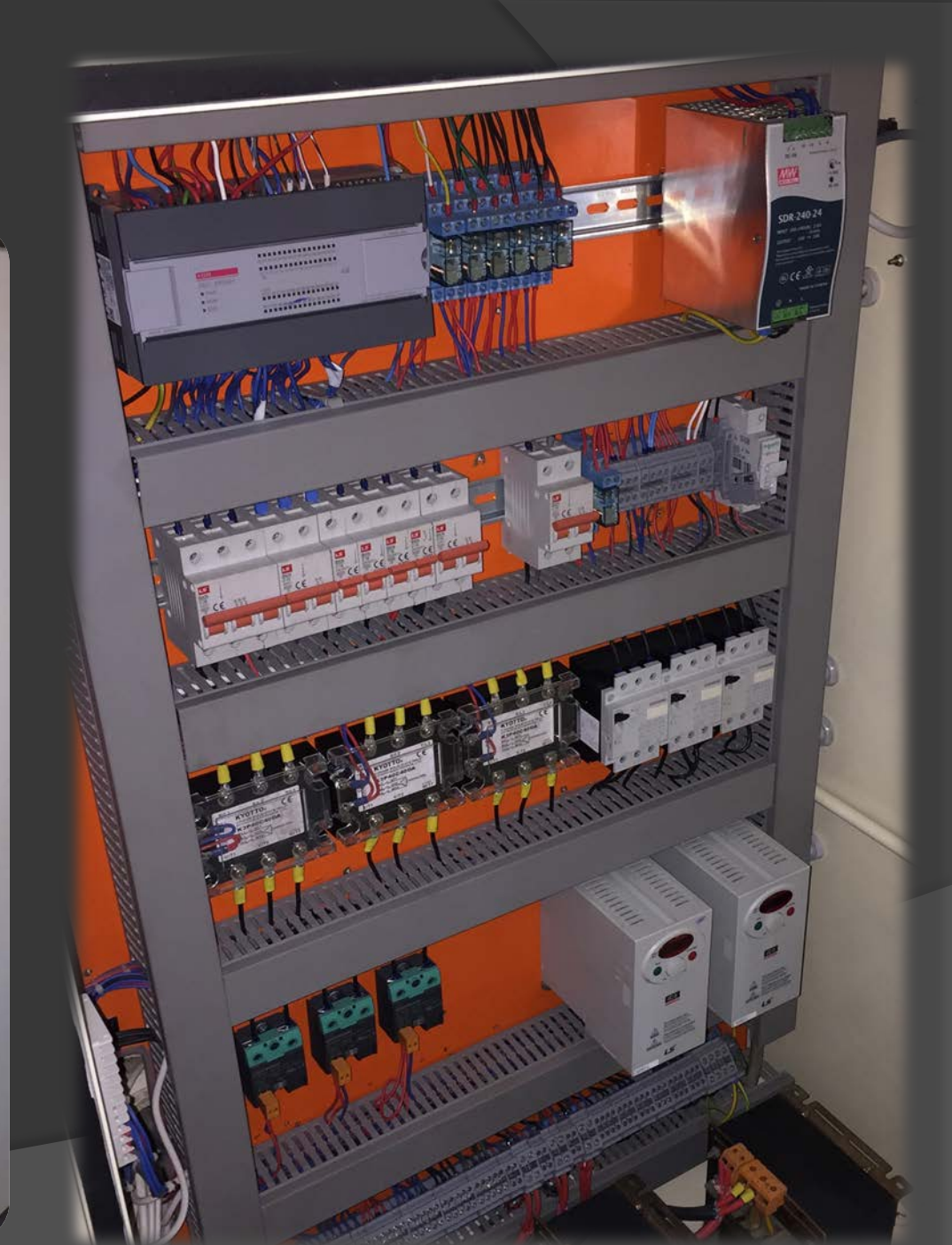
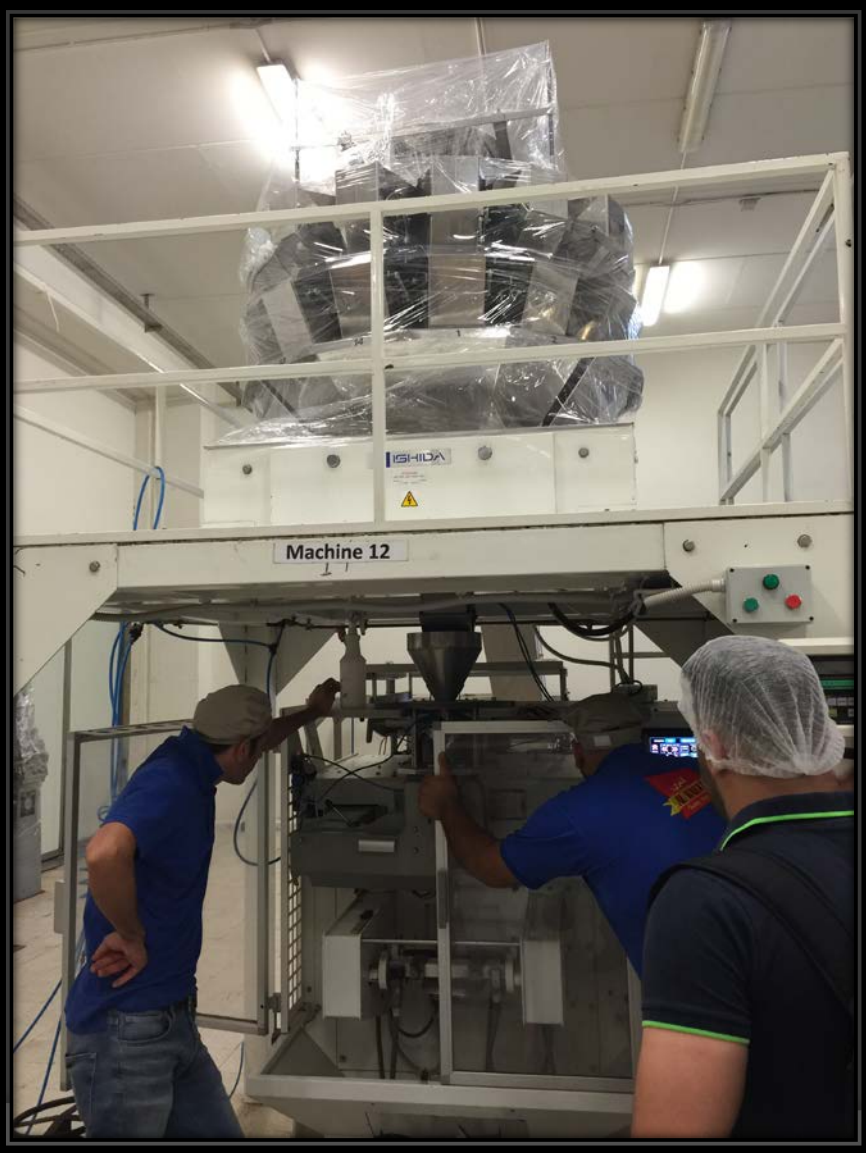



# PLASTIC INJECTION MACHINE





# CONSTANT WATER PRESSURE CONTROL SYSTEM USING PLC & VFD



PID CONTROL



# Our VFD units at Sicomo Paper recycling plant





# Our VFD units at Pharmaline, Four 160kW Air Conditioning chiller compressors.





# SOLAR WATER PUMPING 80HP

East Beqaa

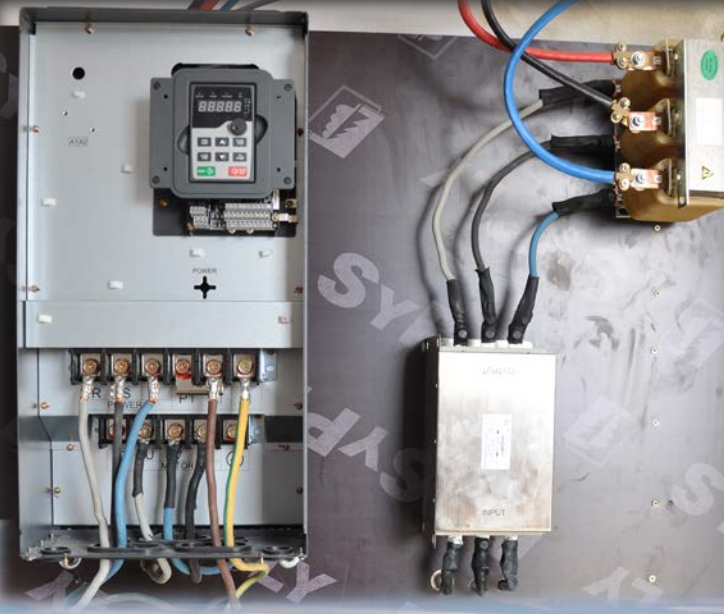

Solar VFD



100kW Array



Distribution



# SOLAR TRACKING SYSTEM 3.6KW



Residential solar system with PV tracker





**N. MICRO**

S.A.R.L.

Meeting & Serving the needs of OEMs in Lebanon & the region since 1996.

**Address #1**

Dora Highway, Dedeyan Center,  
Block A, Ground Floor,  
Beirut, Lebanon  
Tel: +961-1-260404  
Fax: +961-1-260405

Email: [info@narincomicro.com](mailto:info@narincomicro.com)

**Address #2**

Zahle Industrial City,  
Main Road - Naddaf Project No. 2  
Tel: +961-70-687200  
Tel: +961-8-931848

**Address #3**

Rmeil, Mar Mikhael,  
Armenia Street,  
Tel: +961-1-443560  
Fax: +961-1-563720