

CARBON – CA6

6mm carbon potentiometers with plastic housing and Ingress Protection rating type IP 54 (high level of protection against dust and also against water splashing), according to IEC 60529. Plastic materials can be self-extinguishable according to UL 94 V-0 under request.

Through-hole and SMD configurations are available. Terminals and collector are normally manufactured in tinned brass, although versions with steel terminals are also available under request. Terminals for through-hole models can be provided straight or crimped, which helps hold the component to the PCB during soldering.

Tapers can be linear, log and antilog; special tapers can also be studied.

ACP's potentiometers can be adjusted from either the front or the back, both in the horizontal and the vertical adjustment types. Thumbwheels and shafts can be ordered either separately or already inserted in the potentiometer.

Potentiometers can be manufactured in a wide range of possibilities regarding:

- Resistance value.
- Tolerance.
- Tapers / variation laws.
- Pitch.
- Positioning of the wiper (standard is at 50% rotation).
- Housing and rotor color.
- Mechanical life.
- Self-extinguishable plastic parts according to UL 94 V-0 under request.

Applications

6mm potentiometers are mainly used in trimming applications, in different markets:

- Industrial: Timers and relays, dimmers, adjustment of output.
- Electronic appliances: volume regulation, temperature controls and function selection.
- Automotive: Lighting regulation, dimmers.
- Measurement and test equipment.
- Telecommunication equipment (antenna amplifiers and receivers, videocomm, intercomm).
- Alarm systems.

CA6 HOW TO ORDER

EXAMPLE: CA6XV2,5-10KA2020 SNP PI WT-6030-BA

Standard features								Extra features					Assembled accessory			
Series	Rotor	Model	Packg.	Ohm value	Taper	Tol.	Life	Track	Snap in	Housing	Rotor	Wiper	Assembly	Ref #	Color	Flam.
1	2	3	4	5	6	7	8	9	10	11	12	13	14			
CA6	X	V2,5		- 10K	A	2020		CA6	SNP			PI	WT	-6030	-BA	

Standard configuration:	CA6 Through-hole	CA6 SMD
Dimensions:	6mm	
Protection:	IP 54 (dust-proof) On request: Self-extinguishable, to meet UL 94 V-0	
Substrate:	Carbon technology	Carbon technology, special for high temperature
Color:	Blue housing + white rotor	Brown housing + grey rotor
Packaging:	Bulk or Tape & Reel	
Wiper position:	at 50% ±15°	
Terminals:	Snap in P (except model CA6VS5)	
Marking:	Resistive value marked on housing. Others on request.	

Customized products: A drawing is requested when ordering a customized product. Series, rotor, model and total resistive value are indicated before the code that includes all special specifications. Example: CA6XH2,5-10K CODE C00120.

1 - Series

■ CA6

2 - Rotors

D	M	N	X
---	---	---	---

3 - Model and pitch

H2,5	HSMD	V2,5	V5	VS5	VSMD	VESMD	VSMD WT...
							<small>(Under request, not readily available)</small>

4 - Packaging

	Trough-hole	SMD models
Bulk	(blank)... ⁽¹⁾	(blank)... ⁽¹⁾
T&R (Tape and 13" reel)	(N.A.) ⁽²⁾	T&R
T&R (Tape and 15" reel)	(N.A.) ⁽²⁾	T&R15

(1) If blank, bulk packaging is implied. (2) N.A., Not Applicable: Tape and Reel packaging is only available for SMD terminals.

5 - Resistance value

100Ω	200Ω	220Ω	250Ω	470Ω	500Ω	1KΩ	2KΩ	...	500KΩ	1MΩ	2MΩ	2M2Ω	4M7Ω	5MΩ
100	200	220	250	470	500	1K	2K		500K	1M	2M	2M2	4M7	5M

6 - Resistance law / taper

Lin - Linear	A
Log - Logarithmic	B
Antilog - Antilogarithmic	C
- Special tapers have codes assigned:	CODE YXXXXX

7 - Tolerance

±20%	±25%	±30%	+50%,-30%	±10%	±5%
2020	2525	3030	5030	1010	0505

8 - Operating Life (Cycles)

Standard (1.000 cycles)	(leave blank)
Long life: LV + the number of cycles. ex: LV06 for 6.000 cycles. (others on request)	LVXX: ex: LV06

9 - Cut Track – Open circuit.

Open circuit at beginning of track, fully CCW	PCI
Open circuit at end of track, fully CW	PCF

10 - Terminals

SNAP IN P	SNP
Shorter tip of terminal, TPXX, where XX is tip length (under request)	TPXX, ex: TP20

11 - Housing

Color: For colors other than standard: -See color chart below- CJ-color, ex., red: CJ-RO

12 - Rotor

Color: For colors other than standard: -See color chart below- RT-color; ex., blue: RT-AZ

* Self-extinguishable property, V0, for housing and rotor:

By default, carbon is non self-extinguishable, cermet is Self-extinguishable: (blank)
For carbon: self-extinguishable property can be added. V0 means housing and rotor are V0. If only the housing needs to be V0, then CJ-V0. CJ-V0, RT-V0
If only rotor: RT-V0

13 - Wiper

Wiper position (Standard: 50% ± 15°)	(leave blank)
Initial or CCW	PI
Final or CW	PF
Others: following clock positions; at 3 hours: P3H	PXH, ex: P3H
Wiper torque (Standard: <2Ncm)	(leave blank)
Low torque, < 1.5Ncm	PGB

14 - Potentiometers with assembled accessories

Assembled from terminal side	WT
Assembled from collector side	WTI
Accessory Reference	-XXXX
See list of shafts and thumbwheels available	Example: 6030
Color of shaft or thumbwheel	-YY Example, white: BA
Non self-extinguishable.	(leave blank)
Self-extinguishable according to standard UL 94	-V0
(-V0 in box 17 modifies only the accessory, please, note.)	

For ordering spare accessories:

Accessory reference - color- flammability. XXXX-YY-V0
Ex. 6030-AZ-V0 is a blue self-extinguishable 6030 thumbwheel

Color chart for rotor, housing and accessories

Black ⁽¹⁾	White	Neutral	Transp.	Red	Green	Yellow	Blue	Grey	Brown
NE	BA	IN	TA	RO	VE	AM	AZ	GS	MR

(1) black is not an option for housings.

Rotors

Rotors are drawn in their standard positioning, 50% of rotation. Alternative delivery positioning can be requested. Accessories in this catalogue are designed for the X rotor, unless otherwise stated.

D

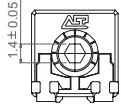

M

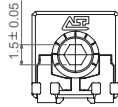

N

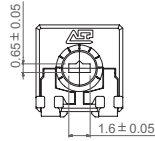

X

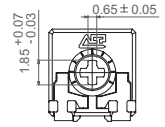

Models

All models shown here have the most common rotor for 6mm potentiometers: the X rotor, which can be paired with any shaft or thumbwheel from this catalogue. Different rotors are available from the menu above.

H2,5

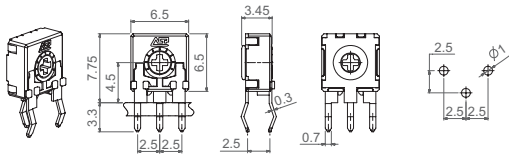

HSMD

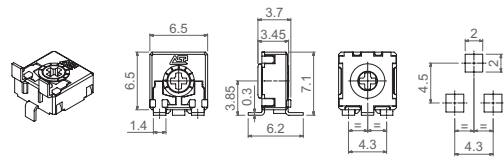

V2,5

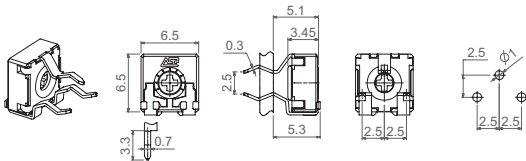

V5

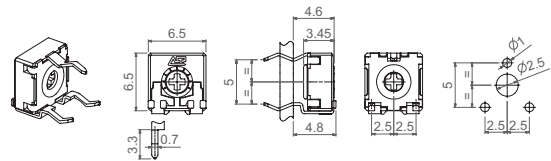

VS5

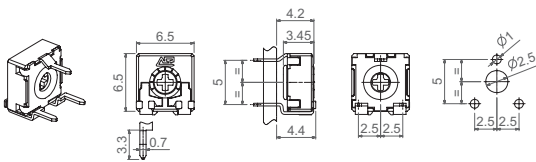

SNP not possible with VS5 model

VSMD

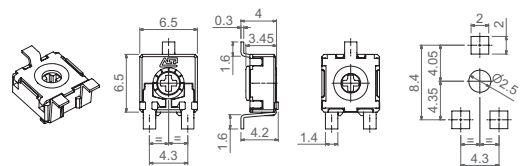

VESMD (Under request, not readily available)

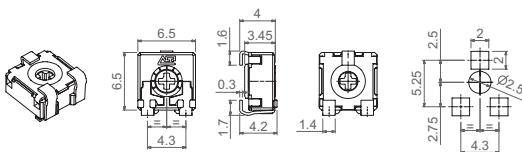

VSMD WT-6030

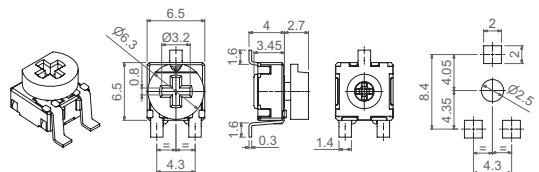

VSMD WT-6037

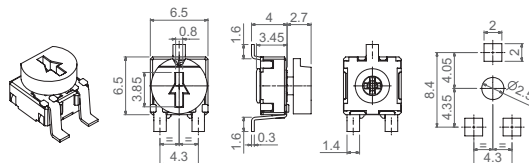

Tapers

The standard taper is linear (A). Log (B) and Antilog (C) tapers are also available, as well as special tapers according to customer's specifications.

REGULAR TAPERS

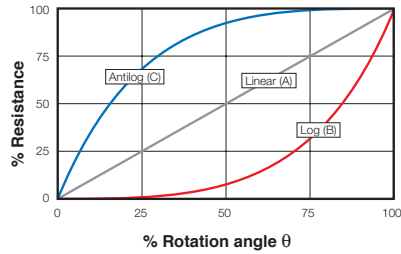

Potentiometers with cut track

The cut track is an area with very high resistive value, resulting in an open circuit. It is widely used in lighting applications. PCI = Cut at initial position, when the potentiometer is turned fully counter clockwise. PCF = Cut at final position, when the potentiometer is turned fully clockwise. Other positions are available on request.

PCI

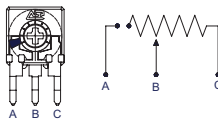

PCF

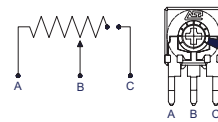

Terminals

By default, terminals are always crimped (with snap in, "SNP") to better hold the component to the PCB during the soldering operation, except for VS5, with short terminals that do not allow for SNP. ACP can provide straight terminals if needed.

SNP

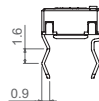

Also, there is an option of having shorter terminal tips.

Possibilities for insertion of accessories

Accessories can be mounted on potentiometers through either the front side (WT) or the collector side (WTI). For the specific angular position of shafts with planes, a drawing with the exact position is requested.

WT Front side

WTI Collector side

WT Front side

WTI Collector side

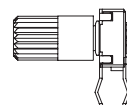
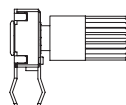
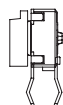
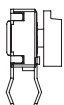

Shafts are available in different colors (color chart in “how to order” section) and with self-extinguishable property, according to UL 94 V-0, under request. ACP can study special shaft designs.

Shafts can be sold separately or delivered already mounted on the potentiometer at ACP.

When a shaft is mounted on a potentiometer, the distance from the top of the potentiometer to the top of the shaft is marked with “L” in the table below, as shown in the drawings:

H potentiometer + shaft

V potentiometer + shaft

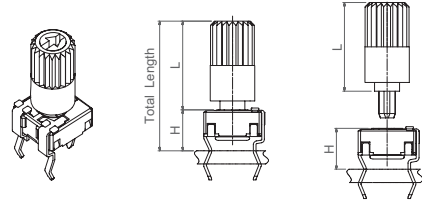
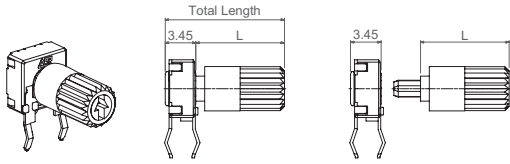

Shaft	6026	6022	6023	6031	6024	6025	6028	6040
L Dimension	2.5	10	10	11	12.2	14.5	14.5	21.3

6022

6023

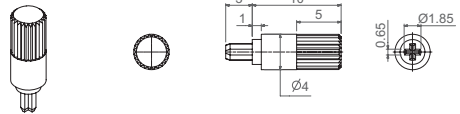
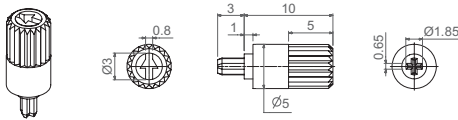

6024

6025

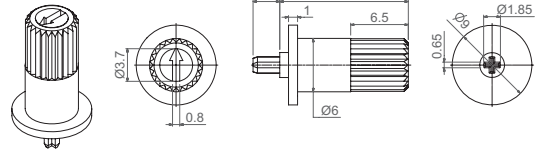
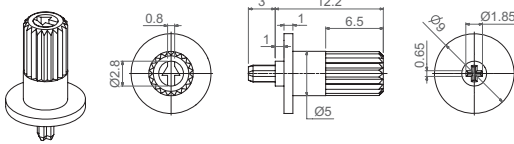

6026

6028

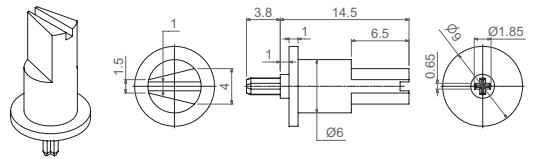
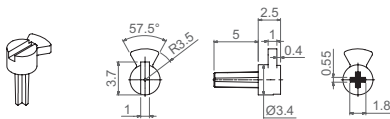

6031

6040

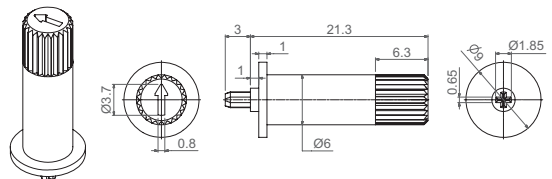
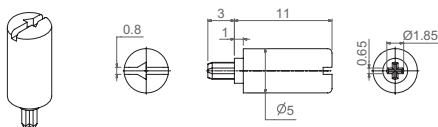

Thumbwheel

Thumbwheels are available in different colors (color chart in “how to order” section) and with self-extinguishable property according to UL 94 V-0, under request. Thumbwheels can be mounted on the potentiometers at ACP (see models with WT-6030 or WT-6037) or sold separately. ACP can study special thumbwheel designs.

6001 **6030**

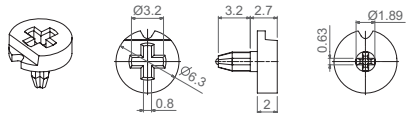
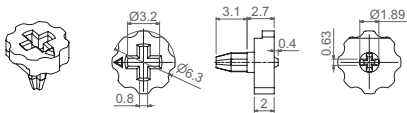

6032 **6034**

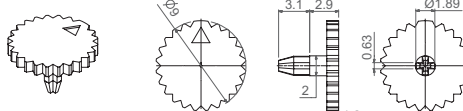
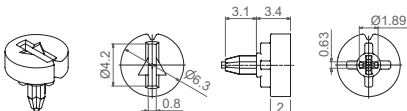

6035 **6037**

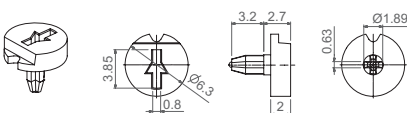
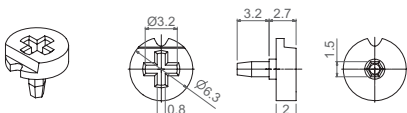

Bulk packaging:

Potentiometer model	With shaft or thumbwheel inserted?	Pieces per small box (150 x 100 x 70)	Pieces per bigger box (250 x 150 x 70, CG on description)
H2,5 - V2,5 - V5 VS5 - HSMD - VSMD	None, only potentiometers.	1.000	4.000
	6001, 6030, 6032, 6037	1.000	3.000
	6024, 6025, 6028	300	To be determined.
	6022, 6023, 6031	500	To be determined.

Tape & Reel packaging:

	With thumbwheel inserted?	13" Reel (Standard), with 24mm width tape	15" Reel, with 24mm width tape
VSMD	None, only potentiometers.	1.200 pcs per reel, 12mm step between cavities.	1.700 pcs per reel, 12mm step between cavities.
	6030 or 6037	750 pcs per reel, 12mm step between cavities.	1.100 pcs per reel, 12mm step between cavities.
HSMD	None, only potentiometers.	750 pcs per reel, 12mm step between cavities.	1.000 pcs per reel, 12mm step between cavities.
	With specific thumbwheel.	Under request.	Under request.

The 13" reel is the standard. For the 15" reel, T&R15 is added to the description.

VSMD-T&R

VSMD-T&R...WT-6030 (or 6037)

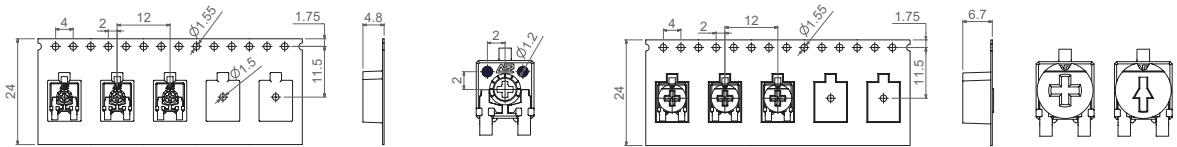

HSMD-T&R

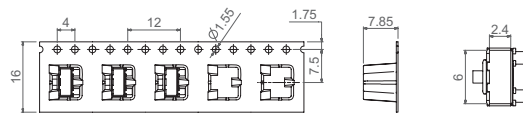

13" Reel

15" Reel

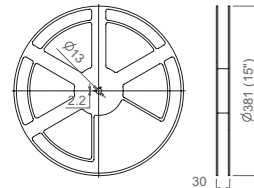
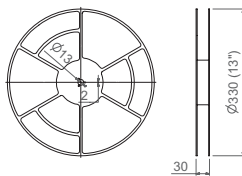

Electric Specifications

These are standard features; other specifications and out of range values can be studied on request.

	CA6 Through-hole	CA6 SMD
Range of resistance values* Lin (A) Log (B) Antilog (C)	100Ω ≤ Rn ≤ 5MΩ 1 KΩ ≤ Rn ≤ 2M2Ω	100Ω ≤ Rn ≤ 1MΩ 1 KΩ ≤ Rn ≤ 1 MΩ
Tolerance* Rn < 100Ω: 100Ω ≤ Rn ≤ 100KΩ: 100K < Rn ≤ 1MΩ: 1MΩ < Rn ≤ 5MΩ: Rn > 5MΩ:	+50%, -30% (out of range) ±20% ±20% ±30% +50%, -30% (out of range)	- ±25% ±25% ±50% -
Variation laws	Lin (A), Log (B), Antilog (C). Other tapers available on request	
Residual resistance	Lin (A), Log (B), Antilog (C) ≤ 5*10 ⁻³ *Rn. Minimum value 2Ω	
CRV - Contact Resistance Variation (dynamic)	≤3%Rn	
CRV - Contact Resistance Variation (static)	≤5%Rn	
Maximum power dissipation** Lin (A) Log (B), Antilog (C)	at 50°C 0.10W 0.06W	
Maximum voltage Lin (A) Log (B), Antilog (C)	100VDC 60VDC	
Operating temperature	-25°C ... +70°C (+85°C on request)	
Temperature coefficient 100Ω ≤ Rn ≤ 10KΩ 10KΩ < Rn ≤ 5MΩ	+200/ -300 ppm +200/ -500 ppm	+200/ -500 ppm +200/ -1000 ppm

* Out of range ohm values and tolerances are available on request, please, inquire.

** Dissipation of special tapers will vary, please, inquire.

Mechanical Specifications

	CA6 Through-hole	CA6 SMD
Resistive element	Carbon technology	Carbon technology
Angle of rotation (mechanical)	235° ± 10°	
Angle of rotation (electrical)	215° ± 20°	
Wiper standard delivery position	50% ± 15°	
Max. stop torque	4 Ncm	
Max. push/pull on rotor	9.8 N	
Wiper torque*	<2 Ncm	
Mechanical life	1.000 cycles (others available on request)	

* Stronger or softer torque feeling is available on request.

Test results

The following typical test results are given at 23°C ±2°C and 50% ±25% RH.

	Test conditions	Typical variation of nominal resistance
Damp heat	500 h. at 40°C and 95% RH	+5%, -2%
Thermal cycles	16 h at 85°C, plus 2 h at -25°C	±2.5%
Load life	1.000 h. at 50°C	+0%; -6%
Mechanical life	1.000 cycles at 10 c.p.m. and at 23°C ± 2°C	±4%
Soldering effect	2 seconds at 350°C	±1%
Storage (3 years)	3 years at 23°C ± 2°C	±3%

CA6 Through-hole and SMD

Power derating curve:

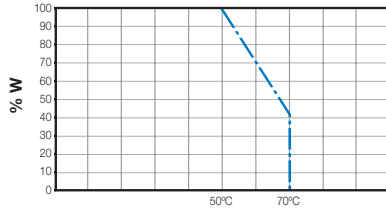

Representation of the typical variation of nominal resistance (with 95% confidence) throughout the ohm value range:

CA6 Through-hole and SMD

Damp heat

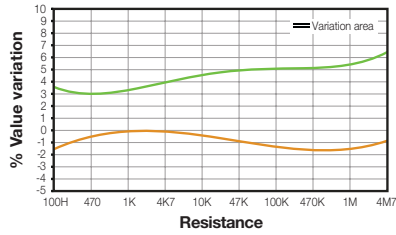

Temperature Coefficient

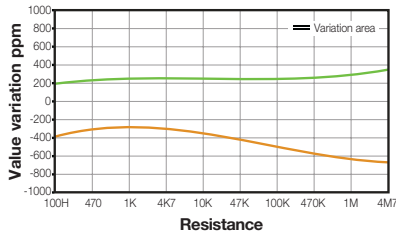

Load life

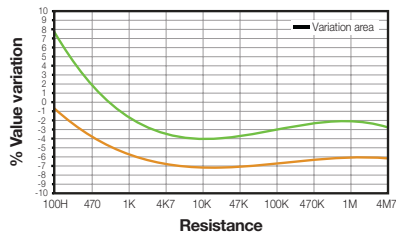

Mechanical life

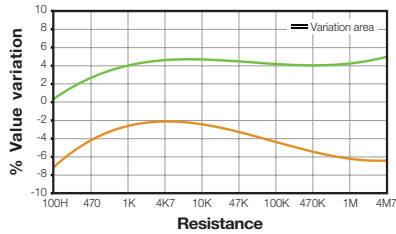

CA9

Carbon Potentiometers CA

CE9

Cermet Potentiometers CE



CARBON – CA9

9mm carbon potentiometers with plastic housing and Ingress Protection rating type IP 54 (high level of protection against dust and also against water splashing), according to IEC 60529. Plastic materials can be self-extinguishable according to UL 94 V-0 under request.

Through-hole and SMD configurations are available. Terminals and collector are normally manufactured in tinned brass, although versions with steel terminals are also available under request. Terminals for through-hole models can be provided straight or crimped, which helps hold the component to the PCB during soldering.

Tapers can be linear, log and antilog; special tapers can also be studied.

ACP's potentiometers can be adjusted from either the front or the back, both in the horizontal and the vertical adjustment types. Thumbwheels and shafts can be ordered either separately or already inserted in the potentiometer.

Potentiometers can be manufactured in a wide range of possibilities regarding:

- Resistance value.
- Tolerance.
- Tapers / variation laws.
- Pitch.
- Positioning of the wiper (standard is at 50% rotation).
- Housing and rotor color.
- Mechanical life.
- Click effect (up to 20 detents available).
- Self-extinguishable plastic parts according to UL 94 V-0.

Applications

9mm potentiometers are mainly used in control applications, in different markets:

- Industrial: Timers and relays, dimmers, adjustment of output.
- Electronic appliances: volume regulation, temperature controls and function selection.
- Automotive: Lighting regulation (position adjustment and sensing for headlights), dimmers, seat heating controls.

CERMET – CE9

9mm cermet potentiometers with plastic housing and Ingress Protection rating type IP 54 (high level of protection against dust and also against water splashing), according to IEC 60529. Plastic materials (housing and rotor) are self-extinguishable according to UL 94 V-0 for ACP's cermet potentiometers.

Cermet potentiometers have better thermal stability, allow for higher thermal dissipation and withstand higher temperatures than carbon potentiometers.

Through-hole and SMD configurations are available. Terminals and collector are manufactured in tinned brass, although versions with steel terminals are also available under request. Terminals for through-hole models can be provided straight or crimped, which helps hold the component to the PCB during soldering.

Tapers can be linear, log and antilog; special tapers can also be studied.

ACP's potentiometers can be adjusted from either the front or the back, both in the horizontal and the vertical adjustment types. Thumbwheels and shafts can be ordered either separately or already inserted in the potentiometer.

Potentiometers can be manufactured in a wide range of possibilities regarding:

- Resistance value.
- Tolerance.
- Tapers / variation laws.
- Pitch.
- Positioning of the wiper (the standard is at 50%).
- Housing and rotor color.
- Mechanical life.
- Click effect (up to 20 detents available).

Applications

9mm cermet potentiometers are used in applications where either the operating temperature is high, or where the application requires product with excellent ohmic value stability:

- Electronic appliances: temperature controls.
- Automotive: climate controls, position sensors, seat heating controls.
- Industrial electronics: multimeters, oscilloscopes, time relays, measurement and test equipment.

CA9 CE9 HOW TO ORDER

EXAMPLE: CA9MH2,5-10KA2020 SNP PI WT-9005-BA

EXAMPLE: CE9MH2,5-10KA2020 SNP PI WT-9005-BA-V0

Standard features								Extra features							Assembled accessory			
Series	Rotor	Model	Packg.	Ohm value	Taper	Tol.	Life	Track	Detents	Snap in	Housing	Rotor	Wiper	Lin.	Assembly	Ref #	Color	Flam.
1	2	3	4	5	6	7	8	9	10	11	12	13	14	15	16			
CA9/CE9	M	H2,5		- 10K	A	2020		SNP				PI		WT	-9005	-BA	-V0	

Standard configuration:	CA9 Through-hole	CA9 SMD	CE9 Through-hole and SMD
Dimensions:		9mm	
Protection:		IP 54 (dust-proof) On request: Self-extinguishable, to meet UL 94 V-0	
Substrate:	Carbon technology	Carbon technology, special for high temperature	Cermet
Color:	Blue housing + white rotor	Brown housing + grey rotor	Brown housing + white rotor
Packaging:		Bulk	
Wiper position:		at 50% ±15°	
Terminals:		Straight, without crimping.	
Marking:		Resistive value marked on housing. Others on request.	

Customized products: A drawing is requested when ordering a customized product. Series, rotor, model and total resistive value are indicated before the code that includes all special specifications. Example: CA9PH2,5-10K CODE C00111.

1 - Series

■ CA9 ■ CE9

2 - Rotors

C D J K KA M MA MT P R Y

3 - Model and pitch

H2,5 H3,8 HS3,8 H5 HSMD V7,5
(Under request, not readily available)

V10 VK10 VR10 MAV10 MTV10 VSMD VSMD WT-9002

4 - Packaging

Trough-hole

SMD models

Bulk	(blank) ⁽¹⁾	(blank) ⁽¹⁾
T&R (Tape and 13" reel)	(N.A.) ⁽²⁾	T&R
T&R (Tape and 15" reel)	(N.A.) ⁽²⁾	T&R15

(1) If blank, bulk packaging is implied. (2) N.A., Not Applicable. Tape and Reel packaging is only available for SMD terminals.

5 - Resistance value

100Ω 200Ω 220Ω 250Ω 470Ω 500Ω 1KΩ 2KΩ ... 500KΩ 1MΩ 2MΩ 2M2Ω 4M7Ω 5MΩ

100 200 220 250 470 500 1K 2K 500K 1M 2M 2M2 4M7 5M

6 - Resistance law / taper

Lin - Linear	A
Log - Logarithmic	B
Antilog - Antilogarithmic	C
- Special tapers have codes assigned:	CODE YXXXXX

7 - Tolerance

±20%	±30%	+50%,-30%	±10%	±5%
2020	3030	5030	1010	0505

8 - Operating Life (Cycles)

Standard (1.000 cycles) (leave blank)

Long life: LV + the number of cycles. ex: LV10 for 10.000 cycles. (others on request) LVXX: ex: LV10

9 - Cut Track – Open circuit.

Open circuit at beginning of track, fully CCW	PCI
Open circuit at end of track, fully CW	PCF

10 - Detents (DT)

One detent at the beginning	DTI
One detent at the end	DTF
X number of detents	XDT: 10DT

Special detents are available on request. If you need to assign a voltage value to each detent, please inquire.

11 - Terminals

SNAP IN P	SNP
SNAP IN J	SNJ
Shorter tip of terminal, TPXX, where XX is tip length (under request)	TPXX, ex: TP25

12 - Housing

Color: For colors other than standard: -See color chart below- CJ-color, ex., red: CJ-RO

13 - Rotor

Color: For colors other than standard: -See color chart below- RT-color; ex., blue: RT-AZ

* Self-extinguishable property, V0, for housing and rotor:

By default, carbon is non self-extinguishable, cermet is self-extinguishable: (blank)
For carbon: self-extinguishable property can be added. V0 means housing and rotor are V0 if only the housing needs to be V0, then CJ-V0. CJ-V0, RT-V0
If only rotor: RT-V0

14 - Wiper

Wiper position (Standard: 50% ± 15°)	(leave blank)
Initial or CCW	PI
Final or CW	PF
Others: following clock positions; at 3 hours: P3H	PXH, ex: P3H
Wiper torque (Standard: <2.5Ncm, for detents: <3.5)	(leave blank)
Low torque, < 1.5Ncm	PGB

15 - Linearity

Not controlled	(leave blank)
Independent linearity controlled & below x%, for example, 3%: LN3%	LNx%; ex: LN3%
Absolute linearity controlled & below x%	LAX%

16 - Potentiometers with assembled accessories

Assembled from terminal side	WT
Assembled from collector side	WTI
Accessory Reference	-XXXXX
See list of shafts and thumbwheels available	Example: 9010
Color of shaft or thumbwheel	-YY Example, white: BA
Non self-extinguishable.	(leave blank)
Self-extinguishable according to standard UL 94 (-V0 in box 17 modifies only the accessory, please, note.)	-V0
For ordering spare accessories:	
Accessory reference - color- flammability.	XXXX-YY-V0
Ex. 9010-AZ-V0 is a blue self-extinguishable 9010 thumbwheel	

Color chart for rotor, housing and accessories

Black ⁽¹⁾	White	Neutral	Transp.	Red	Green	Yellow	Blue	Grey	Brown
NE	BA	IN	TA	RO	VE	AM	AZ	GS	MR

(1) black is not an option for housings.

Rotors

Rotors are drawn in their standard positioning, 50% of rotation. Alternative delivery positioning can be requested. Accessories in this catalogue are designed for the M rotor, unless otherwise stated.

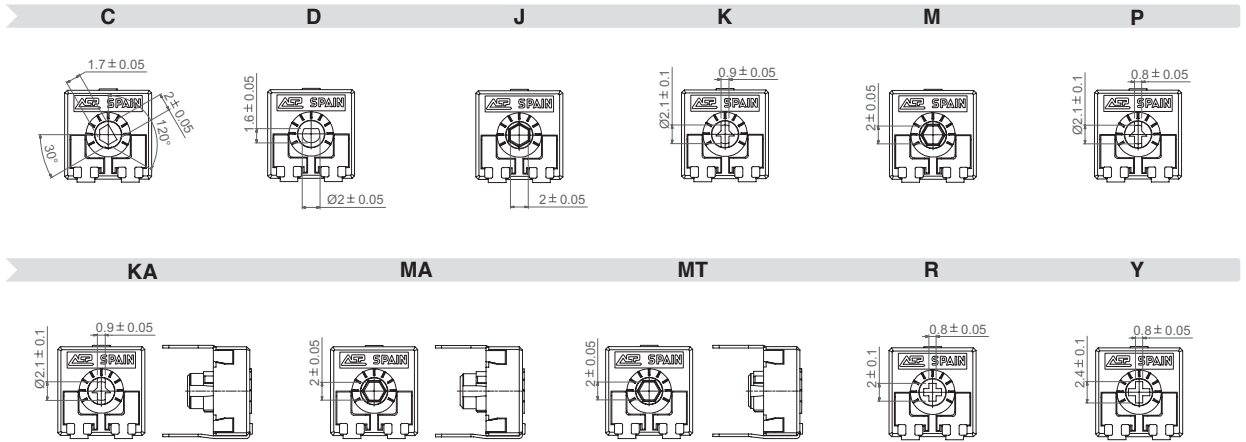

Models

All models shown here have the most common rotor for 9mm potentiometers: the M rotor, which can be paired with any shaft or thumbwheel from this catalogue. Different rotors are available from the menu above.

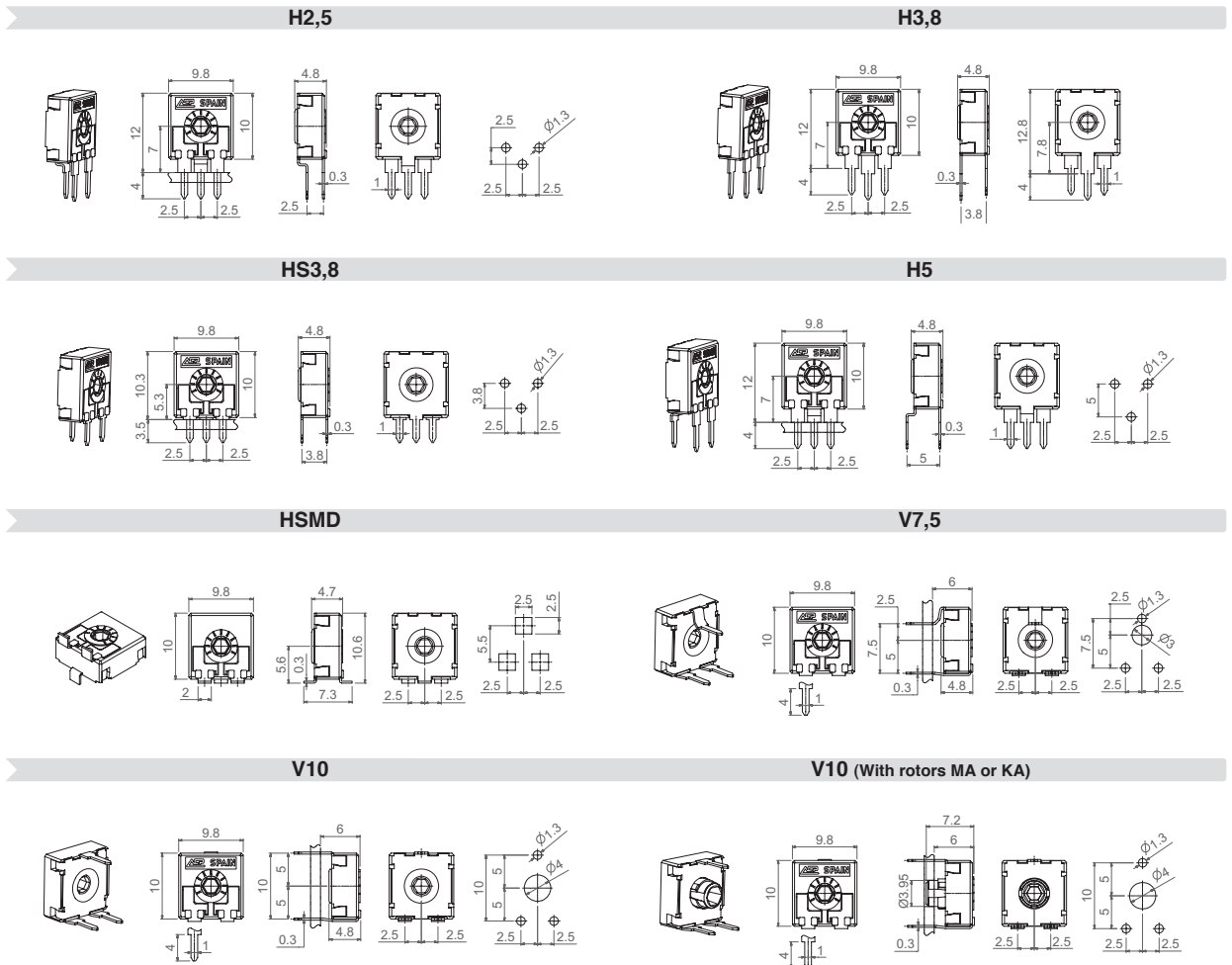

V10 (With rotor MT)

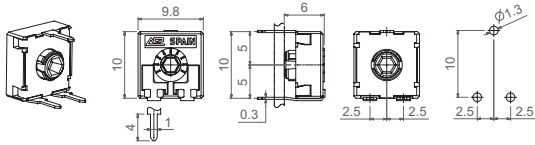

VK10

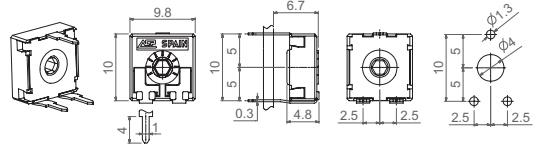

VR10

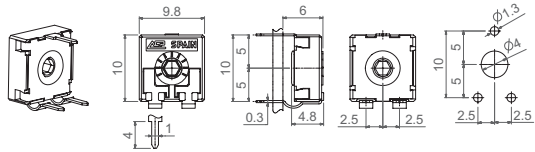

VSM D

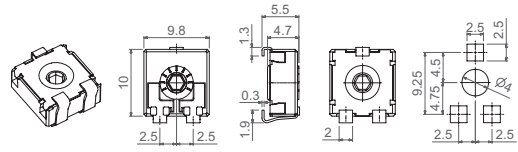

VSM D WT-9002

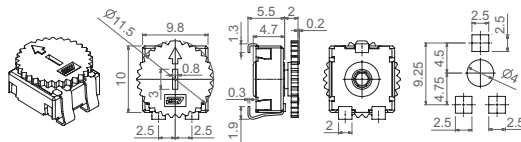

GANGED

GANGED: Set of potentiometers in a row that allows for simultaneous adjustment of all of them through one shaft. Recommended potentiometer model is H2.5. MTX2 (2 potentiometers), MTX4 (4), MTX6 (6), MTX8 (8).

Model	MTX2	MTX4	MTX6	MTX8
Shaft	9048	9039, 9051	9018	9056

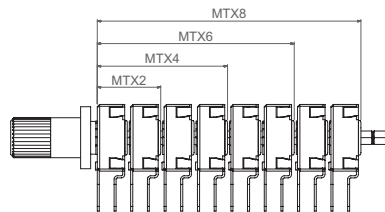

Tapers

The standard taper is linear (A). Log (B) and Antilog (C) tapers are also available, as well as special tapers according to customer's specifications. For example, a special taper can be matched with a potentiometer with detents (click effect) to guarantee a value in a specific position – see "detents" section.-

REGULAR TAPERS

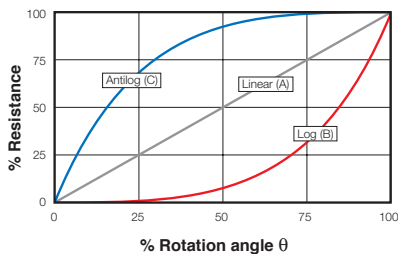

SPECIAL TAPERS

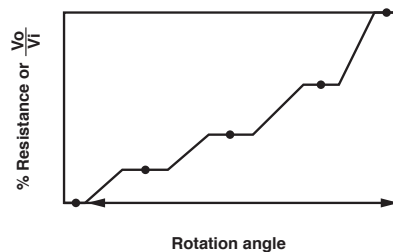

Potentiometers with cut track

The cut track is an area with very high resistive value, resulting in an open circuit. It is widely used in lighting applications. Mechanical life with cut track needs to be confirmed.
 PCI = Cut at initial position, when the potentiometer is turned fully counter clockwise.
 PCF = Cut at final position, when the potentiometer is turned fully clockwise.
 Other positions are available on request.

PCI

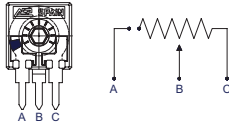

PCF

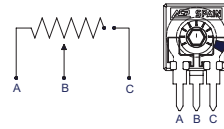

Potentiometers with detents

ACP's patented detent (DT) feature is especially suitable for control applications where the end user will turn a knob inserted in the potentiometer. Detents can be used to add a click feeling to the turning of the potentiometer or to control the position in which the wiper is placed, assuring a particular output value with a narrow tolerance.

Detents can be light or strong, or even a combination of different feelings. They can be evenly distributed along the angle (standard) or tailored to match customers' request. They can also be combined with special tapers: constant value areas, open circuit zone, different slopes, etc. One common example is a potentiometer with detents and matching non-overlapping voltage values in specific angular positions, used to feed in a voltage value to a microprocessor:

Example of 5DT with control of value in each DT.

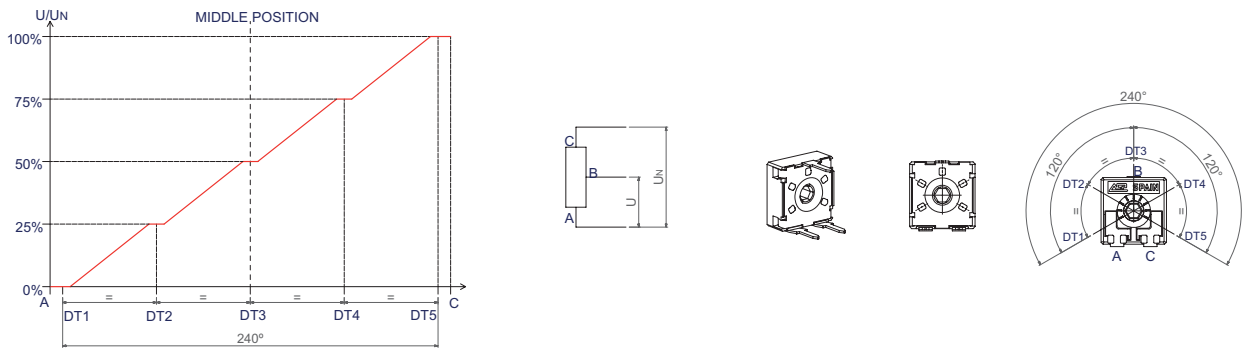

Other examples of potentiometers with detents:

10DT

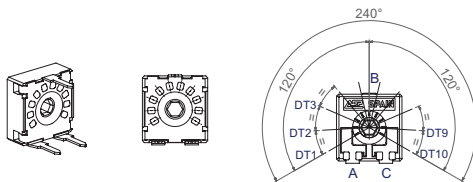

20DT

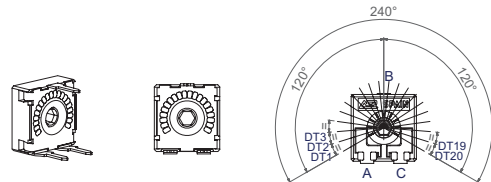

Number of standard detents (evenly distributed) already available.	1 (Initial, final or central), 2 DT (initial and final), 3, 4, 5, 6, 7, 8, 10, 20.
Maximum number of detents for feeling only	20
Maximum number of detents when the voltage value in each detent is controlled and non-overlapping.	10

Our patented design with two wipers has improved the performance of these potentiometers, giving them more stable electrical parameters, improved reliability and Contact Resistance Variation (CRV) as well as narrower tolerances for detent positioning.

For potentiometers with detents, mechanical life is also 1.000 cycles if no additional cycles are mentioned. Please, indicate the number of cycles needed with LV (number of cycles), for example: LV07, for 7.000 cycles.

Terminals

By default, terminals are always straight, as shown on the “models” section. ACP can provide crimped terminals (with snap in, “SNP” or “SNJ”) to better hold the component to the PCB during the soldering operation.

SNP

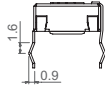

SNJ

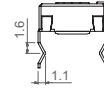

Also, there is an option of having shorter terminal tips:

Standard Terminal

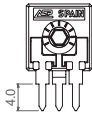

Shorter terminal, for H5 TP25

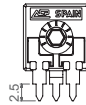

Shorter terminal, TPXX (under request)

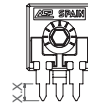

Possibilities for insertion of accessories

Accessories can be mounted on potentiometers through either the front side (WT) or the collector side (WTI). For the specific angular position of shafts with planes, a drawing with the exact position is requested.

WT Front side

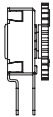

WTI Collector side



WT Front side

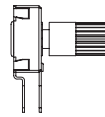

WTI Collector side

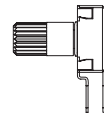

Shafts

Shafts are available in different colors (color chart in “how to order” section) and with self-extinguishable property, according to UL 94 V-0, under request. ACP can study special shaft designs.

Shafts can be sold separately or delivered already mounted on the potentiometer at ACP.

When a shaft is mounted on a potentiometer, the distance from the top of the potentiometer to the top of the shaft is marked with “L” in the table below, as shown in the drawings:

H potentiometer + shaft

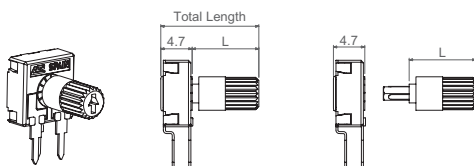

V potentiometer + shaft

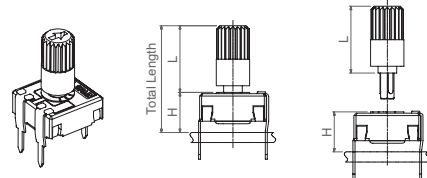

Shaft	9071	9067	9072	9074	9054	9004	9005	9064	9055	9070	9076	9053	9018	9039	9048	9056	9009	9059	9063	9010	9051	9006	9019	9073	9020	9047
L Dimension	3.5	5.5	6.5	9.3	9.5	10	10	10	10.8	11.9	12	12.1	12.8	12.8	12.8	14.5	14.5	14.5	15	15	19.7	19.9	25.5	25.9	29.8	

9004

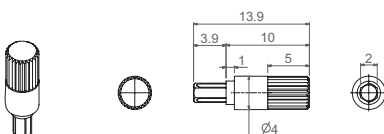

9005

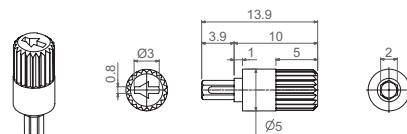

9006

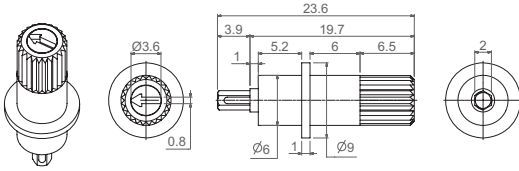

9009

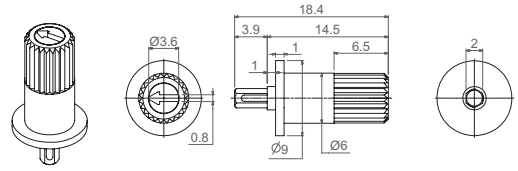

9010

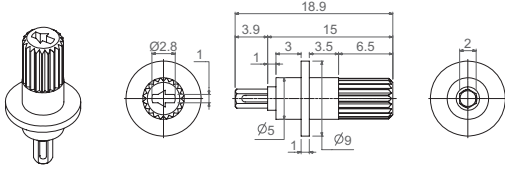

9018

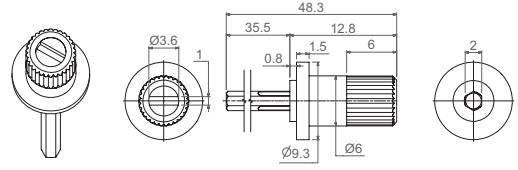

9019

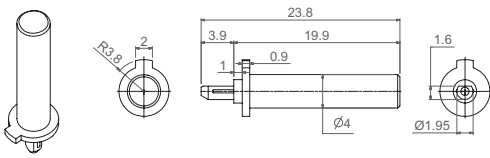

9020

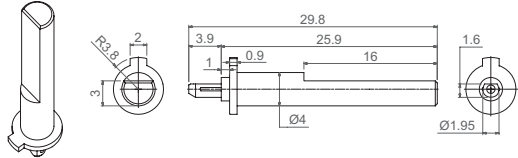

9039

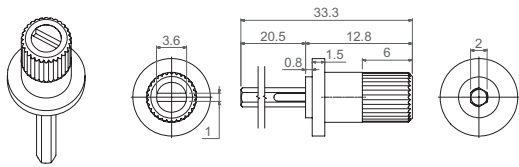

9047

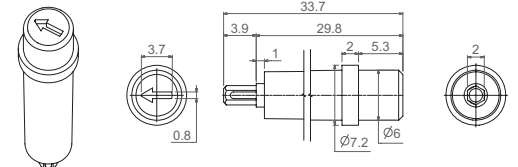

9048

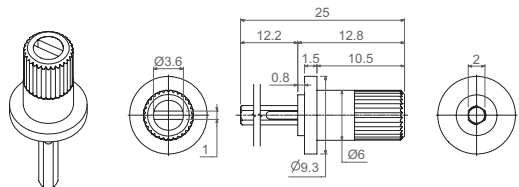

9051

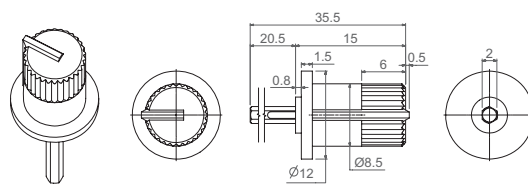

9053

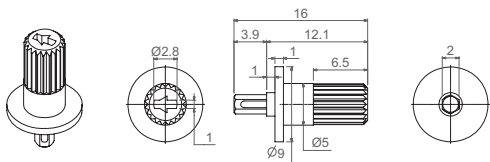

9054

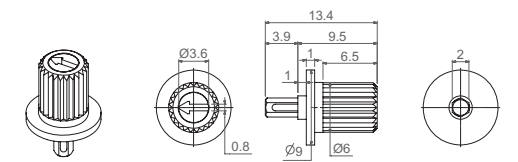

9055

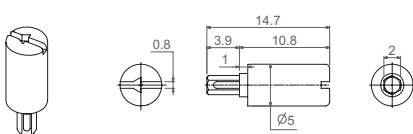

9056

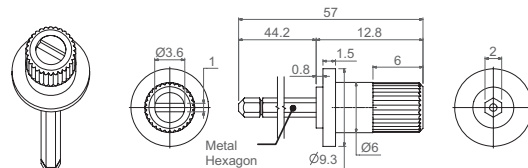

9059

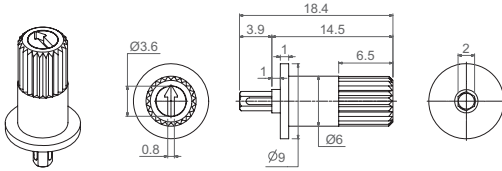

9063

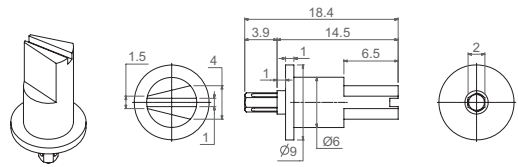

9064

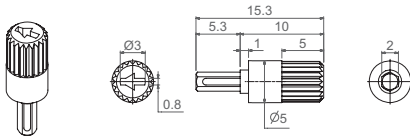

9067

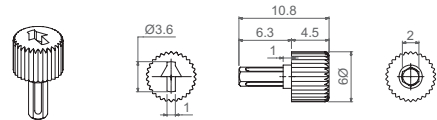

9070

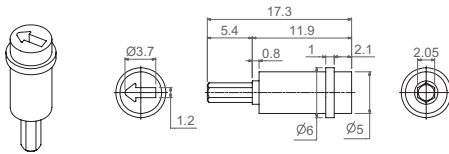

9071

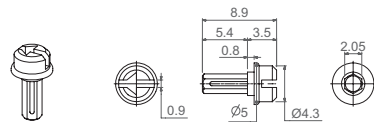

9072

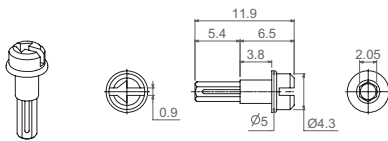

9073

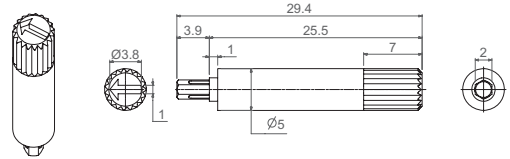

9074

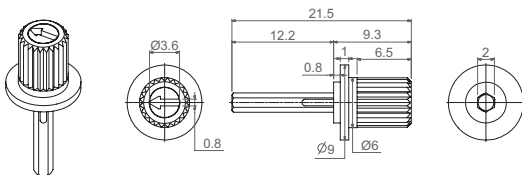

9076

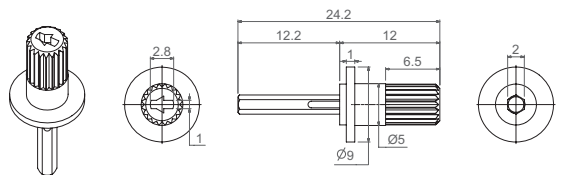

Thumbwheels are available in different colors (color chart in "how to order" section) and with self-extinguishable property according to UL 94 V-0, under request. Thumbwheels can be mounted on the potentiometers at ACP or sold separately. ACP can study special thumbwheel designs.

9002

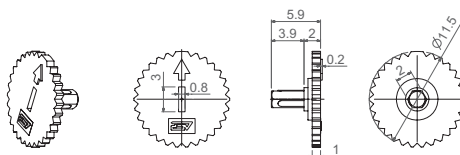

9041

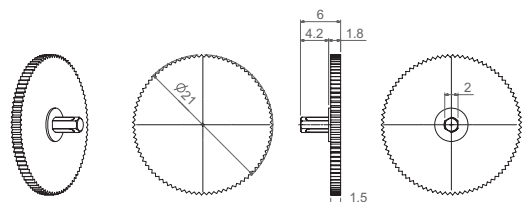

9060

9061

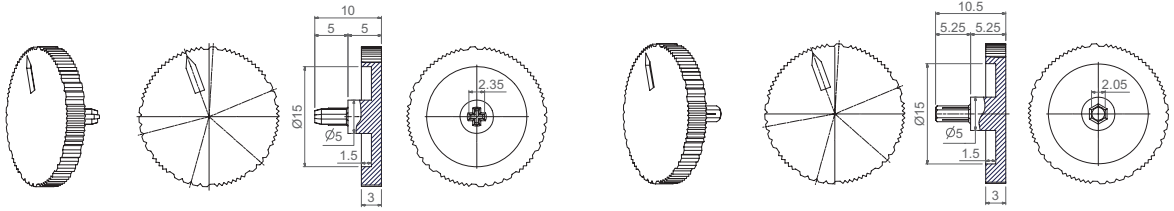

Packaging

Bulk packaging:

Potentiometer model	With shaft or thumbwheel inserted?	Pieces per small box (150 x 100 x 70)	Pieces per bigger box (250 x 150 x 70, CG on description)
H2,5 - H3,8 - H5 HS3,8 - V7,5 - V10 VK10 - VR10 - VSMD	None, only potentiometers.	500	1.500
	9002	250	1.000
	9004, 9005, 9006, 9009, 9010, 9018, 9039, 9041, 9047, 9048, 9051, 9053, 9054, 9055, 9056, 9059, 9060, 9061, 9063, 9064, 9067, 9070.	200	1.000 in general
	9071, 9072	400	1.250
MTX2	9048	150	To be determined.
MTX4	9039, 9051	75	To be determined.
MTX6	9018	50	To be determined.
MTX8	9056	40	To be determined.

Tape & Reel packaging:

	With thumbwheel inserted?	13" Reel (Standard), with 24mm width tape	15" Reel, with 24mm width tape
VSMD	None, only potentiometers.	900 pcs per reel, 12mm step between cavities.	1.250 pcs per reel, 12mm step between cavities.
	9002	700 pcs per reel, 12mm step between cavities.	To be determined.
HSMD		To be determined.	To be determined.

The 13" reel is the standard. For the 15" reel, T&R15 is added to the description.

VSMD-T&R

VSMD-T&R...WT-9002

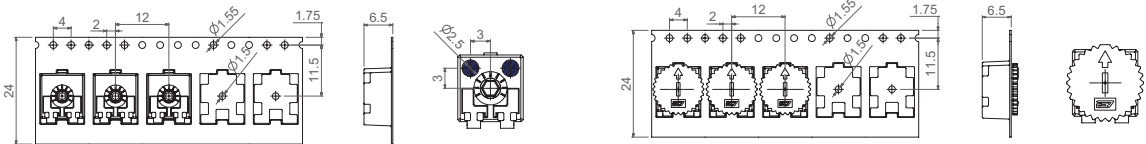

13" Reel

15" Reel



Electric Specifications

These are standard features; other specifications and out of range values can be studied on request.

	CA9 Through-hole	CA9 SMD	CE9 Through-hole and SMD
Range of resistance values* Lin (A) Log (B) Antilog (C)	$100\Omega \leq R_n \leq 5M\Omega$ $1 K\Omega \leq R_n \leq 2M2\Omega$	$100\Omega \leq R_n \leq 1M\Omega$ $1 K\Omega \leq R_n \leq 1 M\Omega$	$100\Omega \leq R_n \leq 5M\Omega$ $1 K\Omega \leq R_n \leq 2M2\Omega$
Tolerance* Rn < 100Ω: 100Ω ≤ Rn ≤ 100KΩ: 100K < Rn ≤ 1MΩ: 1MΩ < Rn ≤ 5MΩ: Rn > 5MΩ:	+50%, -30% (out of range) ±20% ±20% ±30% +50%, -30% (out of range)	- ±30% ±40% ±50% -	- ±20% ±20% ±30% -
Variation laws	Lin (A), Log (B), Antilog (C). Other tapers available on request		
Residual resistance	Lin (A), Log (B), Antilog (C) ≤ 5*10 ⁻³ *Rn. Minimum value 2Ω		≤2Ω
CRV - Contact Resistance Variation (dynamic)	≤3%Rn		
CRV - Contact Resistance Variation (static)	≤5%Rn		
Maximum power dissipation** Lin (A) Log (B), Antilog (C)	at 50°C 0.15W 0.10W		at 70° C. 0.5W 0.20W
Maximum voltage Lin (A) Log (B), Antilog (C)	150VDC 200VDC		200VDC
Operating temperature	-25°C ... +70°C (+85°C on request)		-40°C ... +90°C (+125°C on request)
Temperature coefficient 100Ω ≤ Rn ≤ 10KΩ 10KΩ < Rn ≤ 5MΩ	+200/ -300 ppm +200/ -500 ppm	+200/ -500 ppm +200/ -1000 ppm	±100 ppm ±100 ppm

* Out of range ohm values and tolerances are available on request, please, inquire.

** Dissipation of special tapers will vary, please, inquire.

Mechanical Specifications

	CA9 Through-hole	CA9 SMD	CE9 Through-hole and SMD
Resistive element	Carbon technology	Carbon technology	Cermet
Angle of rotation (mechanical)	240° ± 5°		
Angle of rotation (electrical)	220° ± 20°		
Wiper standard delivery position	50% ± 15°		
Max. stop torque	5 Ncm		
Max. push/pull on rotor	40 N		
Wiper torque*	<2 Ncm Potentiometers with detents: <2.5 Ncm		
Mechanical life	1.000 cycles (many more available on request, please, inquire)		

* Stronger or softer torque feeling is available on request.

Test results

The following typical test results are given at 23°C ±2°C and 50% ±25% RH.

	CA9 Through-hole and SMD		CE9 Through-hole and SMD	
	Test conditions	Typical variation of nominal resistance	Test conditions	Typical variation of nominal resistance
Damp heat	500 h. at 40°C and 95% RH	+5%, -2%	500 h. at 40°C and 95% RH	±2%
Thermal cycles	16 h at 85°C, plus 2 h at -25°C	±2.5%	16 h at 90°C, plus 2 h at -40°C	±2%
Load life	1.000 h. at 50°C	+0%; -6%	1.000 h. at 70°C	±2%
Mechanical life	1.000 cycles at 10 c.p.m. and at 23°C ± 2°C	±3%	1.000 cycles at 10 c.p.m. and at 23°C ± 2°C	±3%
Soldering effect	2 seconds at 350°C	±1%	2 seconds at 350°C	±1%
Storage (3 years)	3 years at 23°C ± 2°C	±3%	3 years at 23°C ± 2°C	±1%

CA9 Through-hole and SMD

CE9 Through-hole and SMD

Power derating curve:

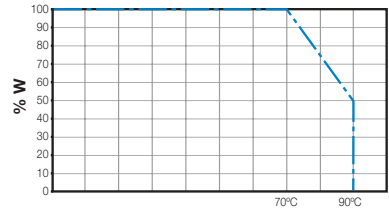
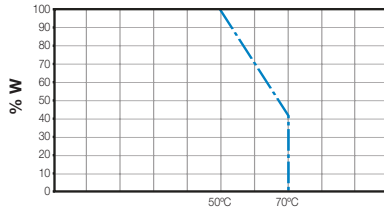

For temperatures out of range

The normal operation temperature for a carbon ACP potentiometer is -25°C to +70°C. When the temperature goes up to 85°C, the following variations should be observed:

Load life	1.000 h. at 50°C	+0%; -6%	1.000 h. at 85°C	+0%; -15%
-----------	------------------	----------	------------------	-----------

The power derating curve to consider is:

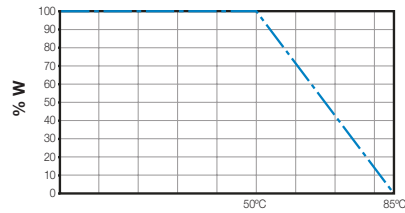

Representation of the typical variation of nominal resistance (with 95% confidence) throughout the ohm value range:

CA9 Through-hole and SMD

CE9 Through-hole and SMD

Damp heat

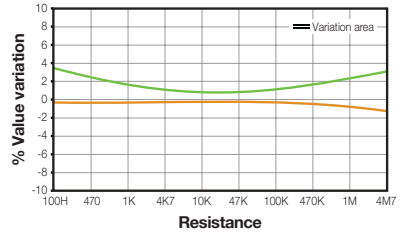
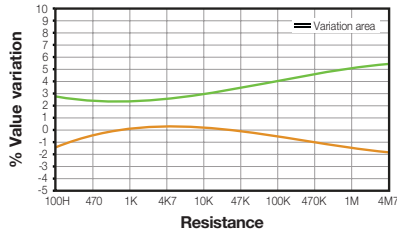

Temperature Coefficient

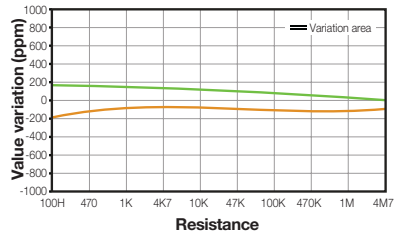
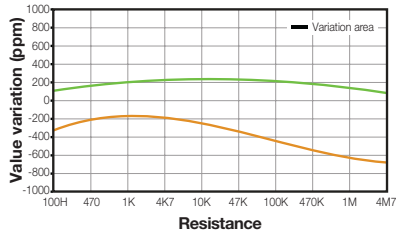

Load life

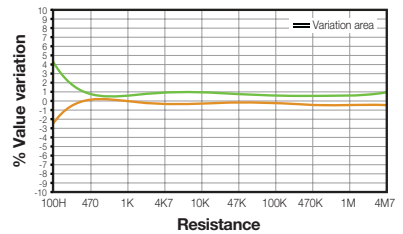
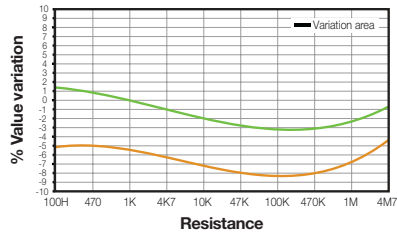

Mechanical life

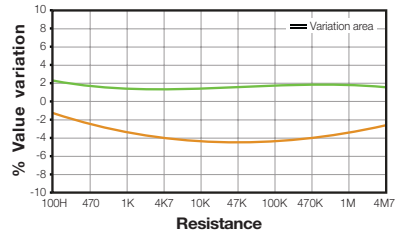
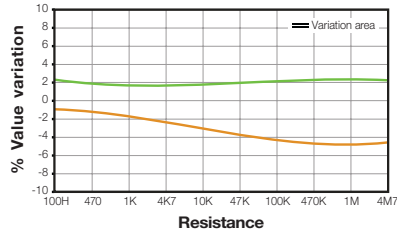

CA14

Carbon Potentiometers CA

CE14

Cermet Potentiometers CE

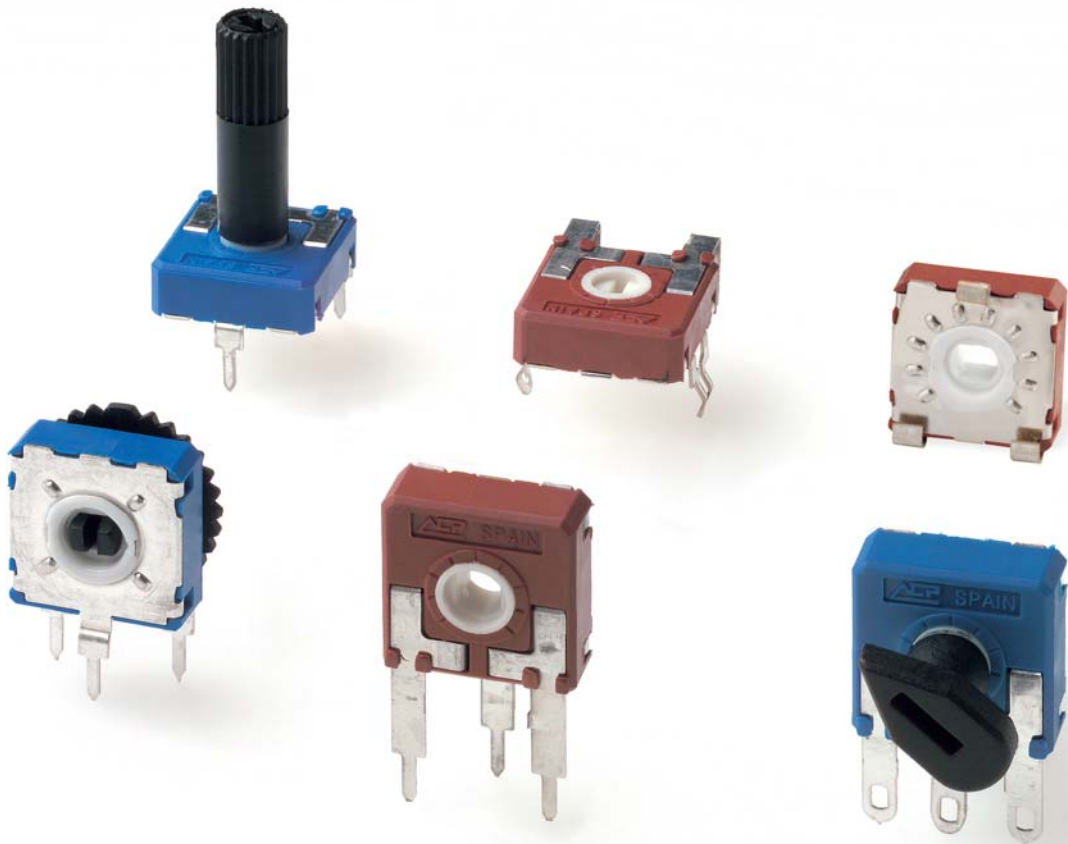

CARBON – CA14

14mm carbon potentiometers with plastic housing and Ingress Protection rating type IP 54 (high level of protection against dust and also against water splashing), according to IEC 60529. Plastic materials can be self-extinguishable according to UL 94 V-0 under request.

Through-hole and SMD configurations are available. Terminals and collector are normally manufactured in tinned brass, although versions with steel terminals are also available under request. Terminals for through-hole models can be provided straight or crimped, which helps hold the component to the PCB during soldering.

Tapers can be linear, log and antilog; special tapers can also be studied.

ACP's potentiometers can be adjusted from either the front or the back, both in the horizontal and the vertical adjustment types. Thumbwheels and shafts can be ordered either separately or already inserted in the potentiometer.

Potentiometers can be manufactured in a wide range of possibilities regarding:

- Resistance value.
- Tolerance.
- Tapers / variation laws.
- Pitch.
- Positioning of the wiper (standard is at 50% rotation).
- Housing and rotor color.
- Mechanical life.
- Click effect (up to 38 detents available).
- Self-extinguishable plastic parts according to UL 94 V-0.

Applications

14mm potentiometers are mainly used in control applications in different markets:

- Electronic household appliances, heating, ventilation and air conditioning (HVAC) equipment, thermostats.
- Automotive: HVAC controls, lighting regulation (position adjustment and sensing), dimmers, seat heating controls.
- Industrial electronics: multimeters, oscilloscopes, time relays, measurement and test equipment.

CERMET – CE14

14mm cermet potentiometers with plastic housing and Ingress Protection rating type IP 54 (high level of protection against dust and also against water splashing), according to IEC 60529. Plastic materials (housing and rotor) are self-extinguishable according to UL 94 V-0. ACP's cermet potentiometers have better thermal stability, allow for higher thermal dissipation and withstand higher temperatures than carbon potentiometers.

Through-hole and SMD configurations are available. Terminals and collector are manufactured in tinned brass, although versions with steel terminals are also available under request. Terminals for through-hole models can be provided straight or crimped, which helps hold the component to the PCB during soldering.

Tapers can be linear, log and antilog; special tapers can also be studied.

ACP's potentiometers can be adjusted from either the front or the back, both in the horizontal and the vertical adjustment types. Thumbwheels and shafts can be ordered either separately or already inserted in the potentiometer.

Potentiometers can be manufactured in a wide range of possibilities regarding:

- Resistance value.
- Tolerance.
- Tapers / variation laws.
- Pitch.
- Positioning of the wiper (the standard is at 50%).
- Housing and rotor color.
- Mechanical life.
- Click effect (up to 38 detents available).

Applications

14mm cermet potentiometers are used in applications where either the operating temperature is high, or where the applications requires product with excellent ohmic value stability:

- Electronic appliances: boilers, water heaters.
- Automotive: climate controls, position sensors.
- Industrial electronics: multimeters, oscilloscopes, time relays, measurement and test equipment.

CA14 CE14 HOW TO ORDER

EXAMPLE: **CA14NV12,5-10KA2020 10DT SNP PI WT-14117-BA**

EXAMPLE: **CE14NV12,5-10KA2020 10DT SNP PI WT-14117-BA-V0**

Standard features								Extra features							Assembled accessory			
Series	Rotor	Model	Packg.	Ohm value	Taper	Tol.	Life	Track	Detents	Snap in	Housing	Rotor	Wiper	Lin.	Assembly	Ref #	Color	Flam.
1	2	3	4	5	6	7	8	9	10	11	12	13	14	15	16			
CA14/CE14	N	H2,5		- 10K	A	2020		10DT	SNP				PI		WT	14117	-BA	-V0

Standard configuration:	CA14 Through-hole	CA14 SMD	CE14 Through-hole and SMD
Dimensions:	14mm		
Protection:	IP 54 (dust-proof) On request: Self-extinguishable, to meet UL 94 V-0		
Substrate:	Carbon technology	Carbon technology, special for high temperature	Cermet
Color:	Blue housing + white rotor	Brown housing + grey rotor	Brown housing + white rotor
Packaging:	Bulk		
Wiper position:	at 50% ± 15°		
Terminals:	Straight, without crimping.		
Marking:	Resistive value marked on housing. Others on request.		

Customized products: A drawing is requested when ordering a customized product. Series, rotor, model and total resistive value are indicated before the code that includes all special specifications. Example: CA14PH2,5-10K CODE C00111.

1 - Series

■ CA14 ■ CE14

2 - Rotors

B D E F G K M N P T X Z

3 - Model and pitch

H0 H00 H2,5 H4 H5 HA5 HL5 V12,5 VA12,5 VL12,5
VR12,5 V15 VJ15 (V15) ... CFF V17,5 VD7,5 VD11 VSMD VSMD ... CY
HSMD (Under request, not readily available)

4 - Packaging

	Trough-hole	SMD models
Bulk	(blank)... ⁽¹⁾	(blank)... ⁽¹⁾
T&R (Tape and 13" reel)	(N.A.) ⁽²⁾	T&R
T&R (Tape and 15" reel)	(N.A.) ⁽²⁾	T&R15

(1) If blank, bulk packaging is implied. (2) N.A., Not Applicable. Tape and Reel packaging is only available for SMD terminals.

5 - Resistance value

100Ω 200Ω 220Ω 250Ω 470Ω 500Ω 1KΩ 2KΩ ... 500KΩ 1MΩ 2MΩ 2M2Ω 4M7Ω 5MΩ
100 200 220 250 470 500 1K 2K 500K 1M 2M 2M2 4M7 5M

Other resistive values available on request.

6 - Resistance law / taper

Lin - Linear	A
Log - Logarithmic	B
Antilog - Antilogarithmic	C
- Special tapers have codes assigned:	CODE YXXXXX

7 - Tolerance

±20%	±30%	+50%,-30%	±10%	±5%
2020	3030	5030	1010	0505

8 - Operating Life (Cycles)

Standard (1.000 cycles) (leave blank)
Long life: LV + the number of cycles. ex: LV10 for 10.000 cycles. (others on request) LVXX: ex: LV10

9 - Cut Track - Open circuit.

Open circuit at beginning of track, fully CCW	PCI
Open circuit at end of track, fully CW	PCF

10 - Detents (DT)

One detent at the beginning	DTI
One detent at the end	DTF
X number of detents	XDT: 10DT

Special detents are available on request: If you need to assign a voltage value to each detent, please inquire.

11 - Terminals

SNAP IN P	SNP
SNAP IN R	SNR
Shorter tip of terminal, TPXX, where XX is tip length (under request)	TPXX, ex: TP30

12 - Housing

Color: For colors other than standard: -See color chart below- CJ-color, ex., red: CJ-RO

13 - Rotor

Color: For colors other than standard: -See color chart below- RT-color; ex., blue: RT-AZ

* Self-extinguishable property, V0, for housing and rotor:

By default, carbon is non self-extinguishable, cermet is Self-extinguishable: (blank)
For carbon: self-extinguishable property can be added. V0 means housing and rotor are V0. If only the housing needs to be V0, then CJ-V0.
If only rotor: RT-V0

14 - Wiper

Wiper position (Standard: 50% ± 15°)	(leave blank)
Initial or CCW	PI
Final or CW	PF
Others: following clock positions; at 3 hours: P3H	PXH, ex: P3H
Wiper torque (Standard: <2.5Ncm, for detents: <3.5)	(leave blank)
Low torque, < 1.5Ncm	PGB

15 - Linearity

Not controlled	(leave blank)
Independent linearity controlled & below x%, for example, 3%: LN3%	LNx%; ex: LN3%
Absolute linearity controlled & below x%	LAX%

Other features could be available on request, please, ask.

16 - Potentiometers with assembled accessories

Assembled from terminal side	WT
Assembled from collector side	WTI
Accessory Reference	-XXXX
See list of shafts and thumbwheels available	Example: 14117
Color of shaft or thumbwheel	-YY Example, white: BA
Non self-extinguishable. Self-extinguishable according to standard UL 94 (-V0 in box 17 modifies only the accessory, please, note.)	(leave blank) -V0

For ordering spare accessories:

Accessory reference - color- flammability. XXXX-YY-V0
Ex. 14117-AZ-V0 is a blue self-extinguishable 14117 thumbwheel

Color chart for rotor, housing and accessories

Black ⁽¹⁾	White	Neutral	Transp.	Red	Green	Yellow	Blue	Grey	Brown
NE	BA	IN	TA	RO	VE	AM	AZ	GS	MR

(1) black is not an option for housings.

Rotors

Rotors are drawn in their standard positioning, 50% of rotation. Alternative delivery positioning can be requested. Accessories in this catalogue are designed for N, Z and T rotors, unless otherwise stated.

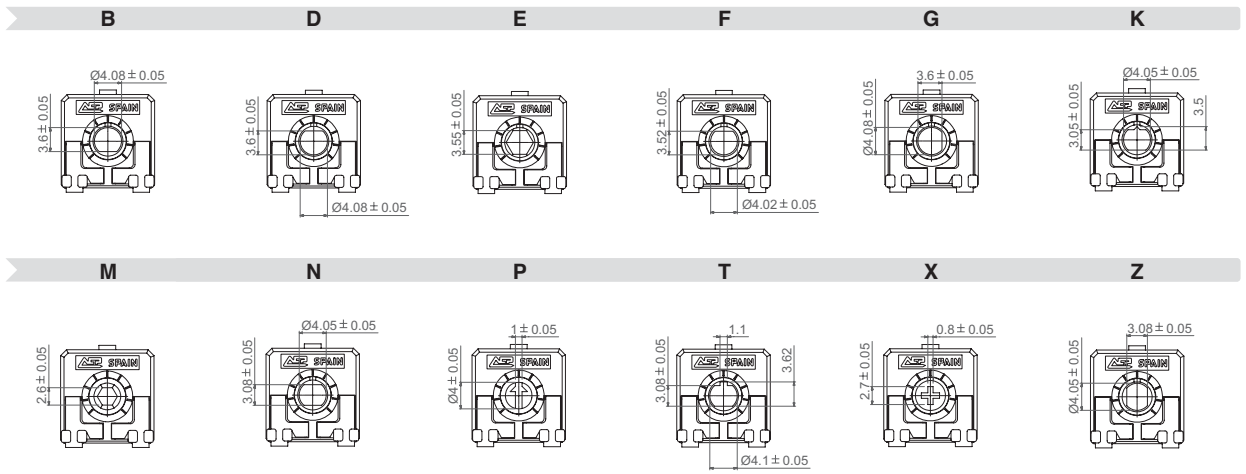

Models

All models shown here have the most common rotor for 14mm potentiometers: the N rotor, which can be paired with any shaft or thumbwheel from this catalogue. Different rotors are available from the menu above.

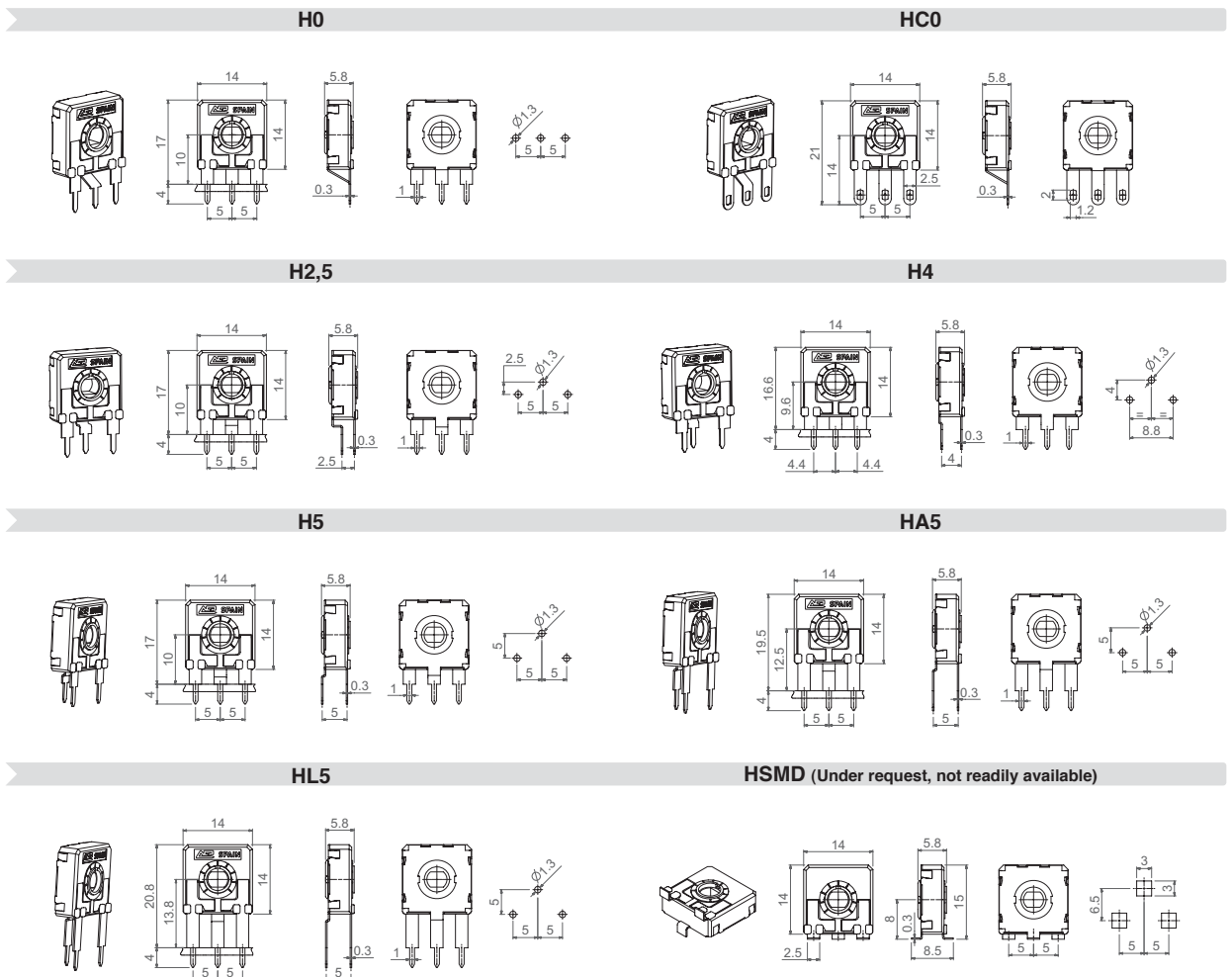

Tapers

The standard taper is linear (A). Log (B) and Antilog (C) tapers are also available, as well as special tapers according to customer's specifications. For example, a special taper can be matched with a potentiometer with detents (click effect), to guarantee a value in a specific position – see "detents" section.-

REGULAR TAPERS

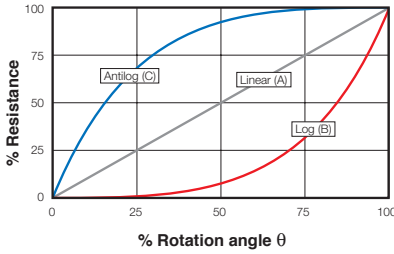

SPECIAL TAPERS

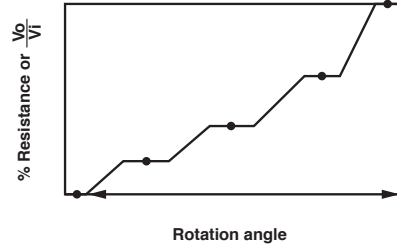

Potentiometers with cut track

The cut track is an area with very high resistive value, resulting in an open circuit. It is widely used in lighting applications. Mechanical life with cut track needs to be confirmed. PCI = Cut at initial position, when the potentiometer is turned fully counter clockwise. PCF = Cut at final position, when the potentiometer is turned fully clockwise. Other positions are available on request.

PCI

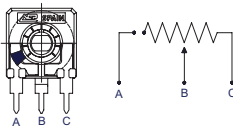

PCF

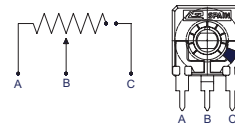

Potentiometers with detents

ACP's patented detent (DT) feature is especially suitable for control applications where the end user will turn a knob inserted in the potentiometer. Detents can be used to add a click feeling to the turning of the potentiometer or to control the position in which the wiper is placed, assuring a particular output value with a narrow tolerance.

Detents can be light or strong, or even a combination of different feelings. They can be evenly distributed along the angle (standard) or tailored to match customers' request. They can also be combined with special tapers: constant value areas, open circuit zone, different slopes, etc. One common example is a potentiometer with detents and matching non-overlapping voltage values in specific angular positions used to feed in a voltage value to a microprocessor:

Example of 5DT with control of value in each DT.

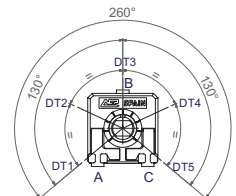
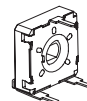
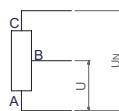
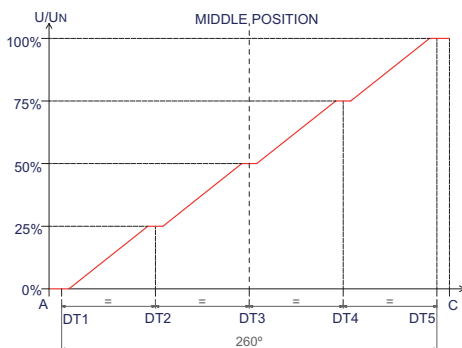

Potentiometers with detents

Examples of some potentiometers with detents:

14DT

38DT

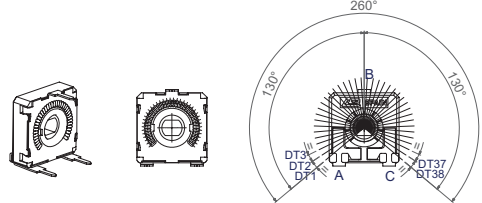
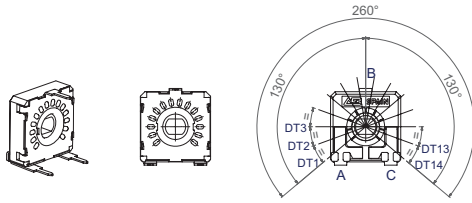

Number of standard detents (evenly distributed) already available. Other configurations are available under request.	1 (Initial, final or central), 3, 4, 5, 6, 7, 8, 9, 10, 13, 14, 17, 22, 27, 38.
Maximum number of detents for feeling only	38
Maximum number of detents when the voltage value in each detent is controlled and non-overlapping.	14

Our patented design with two wipers has improved the performance of these potentiometers, giving them more stable electrical parameters, improved reliability and Contact Resistance Variation (CRV) and narrower tolerances for detent positioning.

For potentiometers with detents, mechanical life is also 1.000 cycles, if no additional cycles are mentioned. Up to 10.000 cycles are available. Please, indicate the number of cycles needed with LV (number of cycles), for example: LV10, for 10.000 cycles.

Terminals

By default, terminals are always straight, as shown on the “models” section. ACP can provide crimped terminals (with snap in, “SNP” or “SNR”) to better hold the component to the PCB during the soldering operation.

SNP

SNR

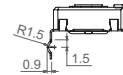
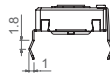

Also, there is an option of having shorter terminal tips:

Standard Terminal

Shorter terminal, for V12,5 TP30

Shorter terminal, TPXX (under request)

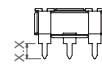

Possibilities for insertion of accessories

Accessories can be mounted on potentiometers through either the front side (WT) or the collector side (WTI). For the specific angular position of shafts with planes, a drawing with the exact position is requested.

WT Front side

WTI Collector side

WT Front side

WTI Collector side

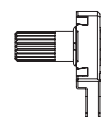
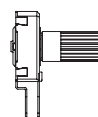

Shafts

Shafts are available in different colors (color chart in “how to order” section) and with self-extinguishable property, according to UL 94 V-0, under request. ACP can study special shaft designs.

Shafts can be sold separately or delivered already mounted on the potentiometer at ACP.

When a shaft is mounted, the distance from the top of the potentiometer to the top of the shaft is marked with “L” in the table below, as shown in the drawings:

H potentiometer + shaft

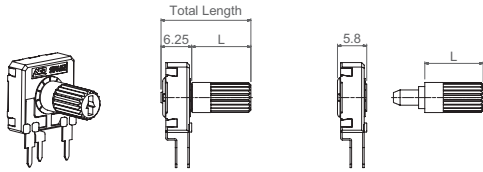

V potentiometer + shaft

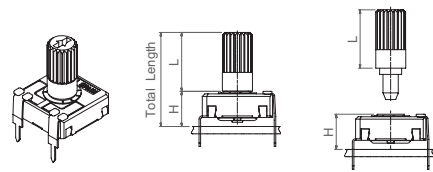

Shaft	14042	14252	14065 (For E rotor)	14117	14056	14253	14081	14187	14251	14067	14008	14015	14066	14084	14250	14072	14073
L Dimension	7.05	11.25	11.50	11.70	12.25	13.75	18.25	18.75	18.75	27.75	23.25	23.25	23.50	23.50	25.00	31.75	38.50

14008

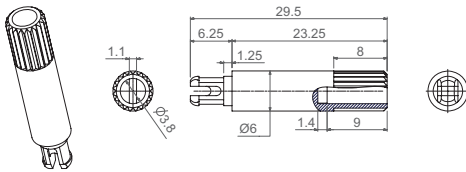

14015

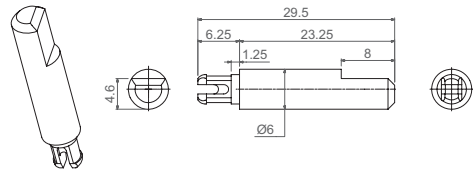

14042

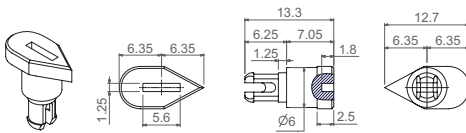

14056

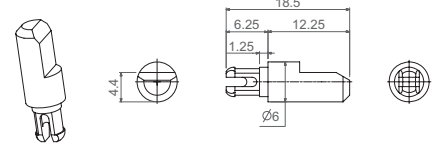

14065 (For E rotor)

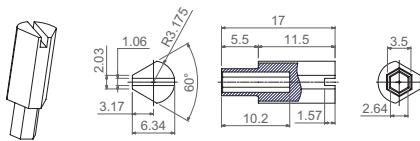

14066

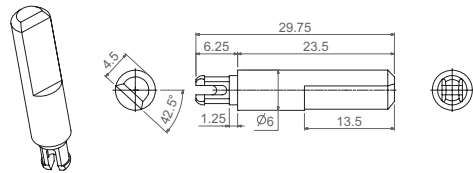

14067

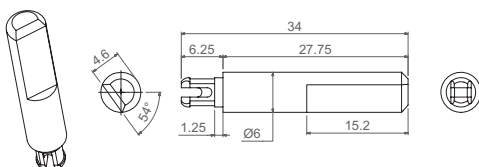

14072

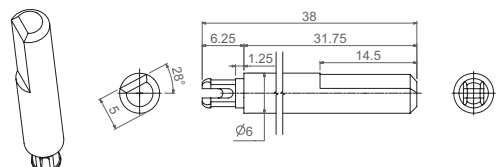

14073

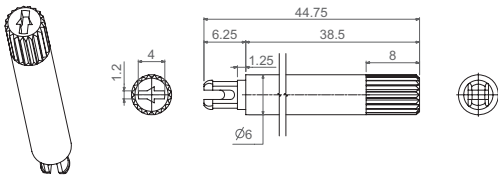

14081

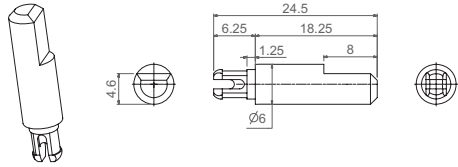

14084

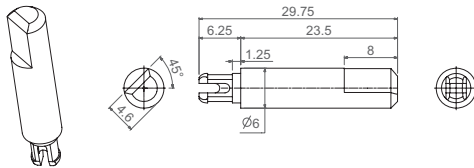

14117

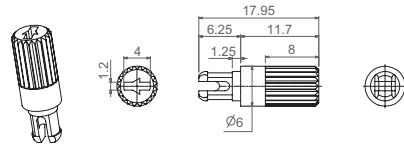

14187

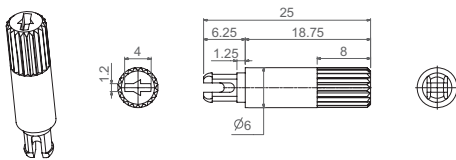

14250

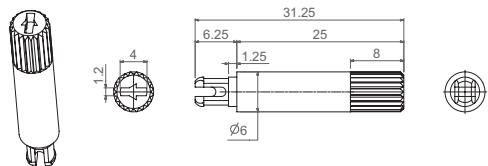

14251

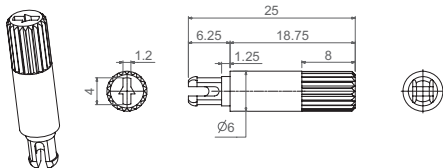

14252

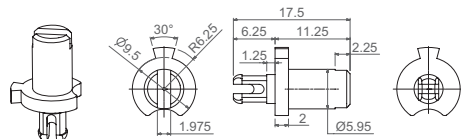

14253

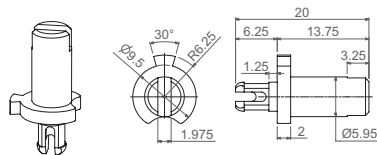

Thumbwheels are available in different colors (color chart in “how to order” section) and with self-extinguishable property according to UL 94 V-0, under request. Thumbwheels can be mounted on the potentiometers at ACP or sold separately. ACP can study special thumbwheel designs.

14003

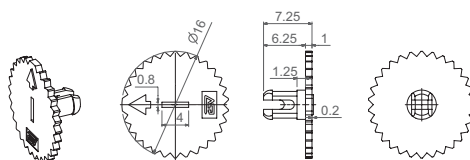

Bulk packaging:

Potentiometer model	With shaft or thumbwheel inserted?	Pieces per small box (150 x 100 x 70)	Pieces per bigger box (250 x 150 x 70, CG on description)
H2,5 - H4 - H5- HA5- HL5- H0 V12,5 - V15 - VA12,5 - VL12,5 VJ15 - V17,5* - VD11* VD7,5* - VR12,5	None, only potentiometers.	200 150 for models with*	700 600 for VJ15 - V17,5 - VD7,5 500 for VD11
	14003, 14117, 14042, 14056, 14065	100	400 350 for models with*
	14008, 14015, 14066, 14067, 14072, 14073, 14081, 14084, 14187, 14250.	75	To be determined.

For models with * and an inserted accessory, please, inquire about the quantity per box in that case. Optional box 140x140x70 is available on request.

Tape & Reel packaging:

	With thumbwheel inserted?	13" Reel (Standard), with 24mm width tape	15" Reel, with 24mm width tape
VSMD	None, only potentiometers.	500 pcs per reel, 16mm step between cavities.	800 pcs per reel, 16mm step between cavities.
	14003	350 pcs per reel, 20mm step between cavities.	To be determined.
VSMD... CY	None, only potentiometers.	350 pcs per reel, 20mm step between cavities.	500 pcs per reel, 20mm step between cavities.
	14003	350 pcs per reel, 20mm step between cavities.	To be determined.
HSMD		To be determined	To be determined.

The 13" reel is the standard. For the 15" reel, T&R15 is added to the description.

VSMD-T&R

VSMD-T&R...WT-14003

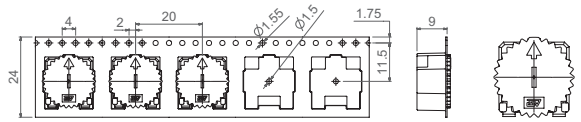
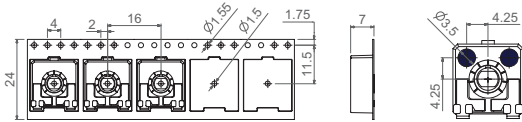

VSMD-T&R ... CY

VSMD-T&R...CY WT-14003

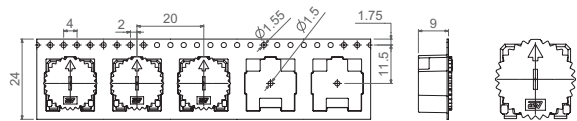
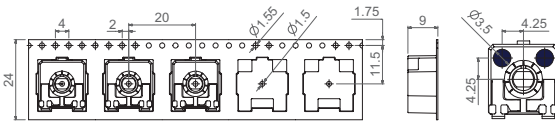

13" Reel

15" Reel

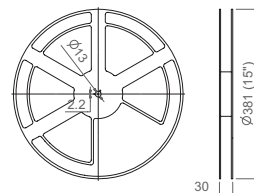
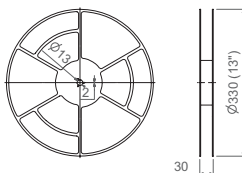

Electric Specifications

These are standard features; other specifications and out of range values can be studied on request.

	CA14 Through-hole	CA14 SMD	CE14 Through-hole and SMD
Range of resistance values* Lin (A) Log (B) Antilog (C)	100Ω ≤ Rn ≤ 5MΩ 1 KΩ ≤ Rn ≤ 2M2Ω	100Ω ≤ Rn ≤ 1MΩ 1 KΩ ≤ Rn ≤ 1 MΩ	100Ω ≤ Rn ≤ 5MΩ 1 KΩ ≤ Rn ≤ 2M2Ω
Tolerance* Rn < 100Ω: 100Ω ≤ Rn ≤ 100KΩ: 100K < Rn ≤ 1MΩ: 1MΩ < Rn ≤ 5MΩ: Rn > 5MΩ:	+50%, -30% (out of range) ±20% ±20% ±30% +50%, -30% (out of range)	- ±30% ±40% ±50% -	- ±20% ±20% ±30% -
Variation laws	Lin (A), Log (B), Antilog (C). Other tapers available on request		
Residual resistance	Lin (A), Log (B), Antilog (C) ≤ 5*10 ⁻³ *Rn. Minimum value 2Ω		≤2Ω
CRV - Contact Resistance Variation (dynamic)	≤3%Rn		
CRV - Contact Resistance Variation (static)	≤5%Rn		
Maximum power dissipation** Lin (A) Log (B), Antilog (C)	at 50°C 0.25W 0.13W		at 70°C. 0.7W 0.30W
Maximum voltage Lin (A) Log (B), Antilog (C)	250VDC 200VDC		
Operating temperature	-25°C ... +70°C (+85°C on request)		-40°C ... +90°C (+125°C on request)
Temperature coefficient 100Ω ≤ Rn ≤ 10KΩ 10KΩ < Rn ≤ 5MΩ	+200/ -300 ppm +200/ -500 ppm	+200/ -500 ppm +200/ -1000 ppm	±100 ppm ±100 ppm

* Out of range ohm values and tolerances are available on request, please, inquire.

** Dissipation of special tapers will vary, please, inquire.

Mechanical Specifications

	CA14 Through-hole	CA14 SMD	CE14 Through-hole and SMD
Resistive element	Carbon technology	Carbon technology	Cermet
Angle of rotation (mechanical)	265° ± 5°		
Angle of rotation (electrical)	245° ± 20°		
Wiper standard delivery position	50% ± 15°		
Max. stop torque	10 Ncm		
Max. push/pull on rotor	50 N		
Wiper torque*	<2.5 Ncm Potentiometers with detents: <3.5 Ncm		
Mechanical life	1.000 cycles (many more available on request, please, inquire)		

* Stronger or softer torque feeling is available on request.

Test results

The following typical test results (with 95% confidence) are given at 23°C ± 2°C and 50% ± 25% RH.

	CA14 Through-hole and SMD		CE14 Through-hole and SMD	
	Test conditions	Typical variation of Rn	Test conditions	Typical variation of Rn
Damp heat	500 h. at 40°C and 95% RH	+5%, -2%	500 h. at 40°C and 95% RH	±2%
Thermal cycles	16 h at 85°C, plus 2 h at -25°C	±2.5%	16 h at 90°C, plus 2 h at -40°C	±2%
Load life	1.000 h. at 50°C	+0%; -5%	1.000 h. at 70°C	±2%
Mechanical life	1.000 cycles at 10 c.p.m. and at 23°C ± 2°C	±3%	1.000 cycles at 10 c.p.m. and at 23°C ± 2°C	±2%
Soldering effect	2 seconds at 350°C	±1%	2 seconds at 350°C	±1%
Storage (3 years)	3 years at 23°C ± 2°C	±3%	3 years at 23°C ± 2°C	±1%

CA14 Through-hole and SMD

CE14 Through-hole and SMD

Power derating curve:

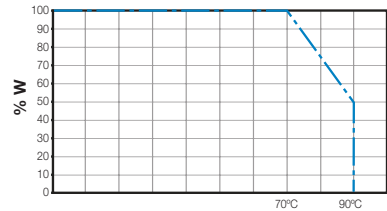
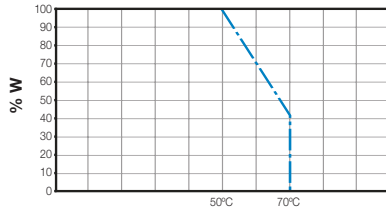

For temperatures out of range

The normal operation temperature for a carbon ACP potentiometer is -25°C to +70°C. When the temperature goes up to 85°C, the following variations should be observed:

Load life	1.000 h. at 50°C	+0%; -6%	1.000 h. at 85°C	+0%; -15%
-----------	------------------	----------	------------------	-----------

The power derating curve to consider is:

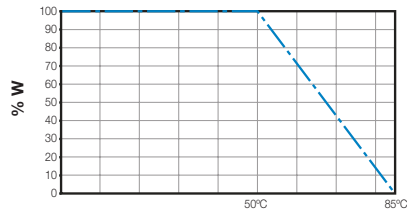

Representation of the typical variation of nominal resistance (with 95% confidence) throughout the ohm value range:

CA14 Through-hole and SMD

CE14 Through-hole and SMD

Damp heat

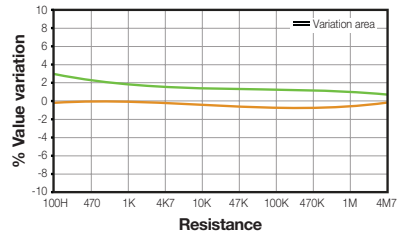
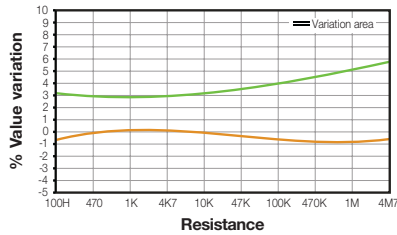

Temperature Coefficient

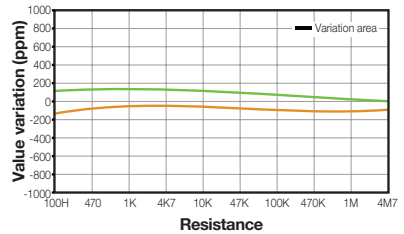
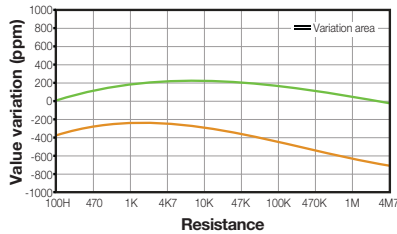

Load life

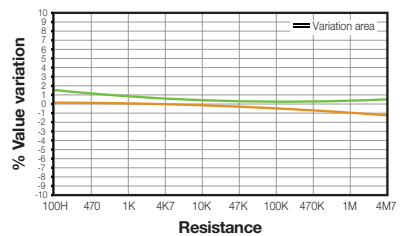
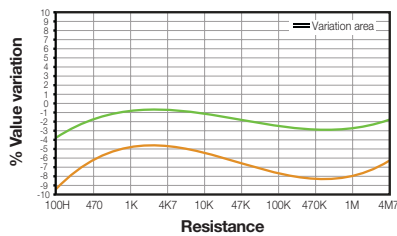

Mechanical life

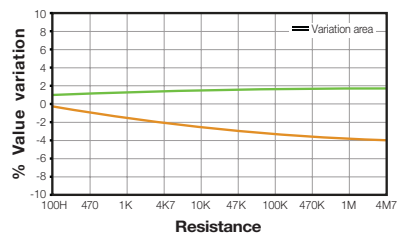
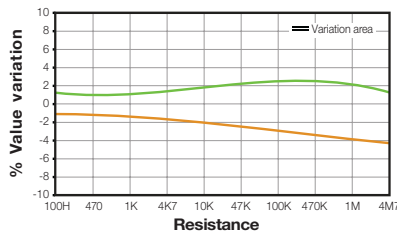

MCA9

Control Carbon
Potentiometers CA



MCE9

Control Cermet
Potentiometers CE



CARBON – MCA9

9mm carbon potentiometers with plastic enclosure and shaft.

Through-hole and SMD configurations are available. Terminals and collector are normally manufactured in tinned brass, although versions with steel terminals are also available under request. Terminals for through-hole models can be provided straight or crimped, which helps hold the component to the PCB during soldering.

Ingress Protection rating type IP 54 (high level of protection against dust and also against water splashing), according to IEC 60529. Plastic materials can be self-extinguishable according to UL 94 V-0 under request.

Tapers can be linear, log and antilog; special tapers can also be studied.

Potentiometers can be manufactured in a wide range of possibilities regarding:

- Resistance value.
- Tolerance.
- Tapers / variation laws.
- Pitch.
- Positioning of the wiper (standard is at 50% rotation).
- Housing and rotor color.
- Mechanical life.
- Click effect (up to 20 detents available).
- Self-extinguishable plastic parts, according to UL 94 V-0.

Applications

9mm potentiometers are mainly used in control applications, in different markets:

- Industrial: Timers and relays, dimmers, adjustment of output.
- Electronic appliances: volume regulation, temperature controls and function selection.
- Automotive: Lighting regulation (position adjustment and sensing for headlights), dimmers, seat heating controls.

CERMET – MCE9

9mm cermet potentiometers with plastic enclosure and shaft. Cermet potentiometers have better thermal stability, allow for higher thermal dissipation and withstand higher temperatures than carbon potentiometers.

Through-hole and SMD configurations are available. Terminals and collector are manufactured in tinned brass, although versions with steel terminals are also available under request. Terminals for through-hole models can be provided straight or crimped, which helps hold the component to the PCB during soldering.

Ingress Protection rating type IP 54 (high level of protection against dust and also against water splashing), according to IEC 60529. Plastic materials (housing and rotor) are self-extinguishable according to UL 94 V-0 for ACP's cermet potentiometers.

Tapers can be linear, log and antilog; special tapers can also be studied.

Potentiometers can be manufactured in a wide range of possibilities regarding:

- Resistance value.
- Tolerance.
- Tapers / variation laws.
- Pitch.
- Positioning of the wiper (the standard is at 50%).
- Housing and rotor color.
- Mechanical life.
- Click effect (up to 20 detents available).

Applications

9mm cermet potentiometers are used in applications where either the operating temperature is high or where the application requires product with excellent ohmic value stability:

- Electronic appliances: temperature controls.
- Automotive: climate controls, position sensors, seat heating controls.
- Industrial electronics: multimeters, oscilloscopes, time relays, measurement and test equipment.

MCA9 MCE9 HOW TO ORDER

EXAMPLE: MCA9DH5-10KA2020 SNP PI WT-9020-NE

EXAMPLE: MCE9DH5-10KA2020 SNP PI WT-9020-NE-V0

Standard features								Extra features							Assembled accessory			
Series	Rotor	Model	Packg.	Ohm value	Taper	Tol.	Life	Track	Detents	Snap in	Housing	Rotor	Wiper	Lin.	Assembly	Ref #	Color	Flam.
1	2	3	4	5	6	7	8	9	10	11	12	13	14	15	16			
MCA9/MCE9	D	H5		- 10K	A	2020				SNP			PI		WT	-9020	-NE	-V0

Standard configuration:	MCA9 Through-hole	MCE9 Through-hole
Dimensions:	9mm	
Protection:	IP 54 (dust-proof) On request: Self-extinguishable, to meet UL 94 V-0	
Substrate:	Carbon technology	Cermet
Color:	Blue housing + white rotor	Brown housing + white rotor
Packaging:	Bulk	
Wiper position:	at 50% ±15°	
Terminals:	Straight, without crimping.	
Marking:	Resistive value marked on housing. Others on request.	

Customized products: A drawing is requested when ordering a customized product. Series, rotor, model and total resistive value are indicated before the code that includes all special specifications. Example: MCA9DH2,5-10K CODE C00111.

1 - Series

■ MCA9 ■ MCE9

2 - Rotors

D

3 - Model and pitch

H2,5 H3,8 H5 V7,5 V10 VK10 VR10

4 - Packaging

Trough-hole

Bulk (blank)

5 - Resistance value

100Ω 200Ω 220Ω 250Ω 470Ω 500Ω 1KΩ 2KΩ ... 500KΩ 1MΩ 2MΩ 2M2Ω 4M7Ω 5MΩ

100 200 220 250 470 500 1K 2K 500K 1M 2M 2M2 4M7 5M

6 - Resistance law / taper

Lin - Linear A

Log - Logarithmic B

Antilog - Antilogarithmic C

- Special tapers have codes assigned: CODE YXXXXX

7 - Tolerance

±20% ±30% +50%,-30% ±10% ±5%

2020 3030 5030 1010 0505

8 - Operating Life (Cycles)

Standard (1.000 cycles) (leave blank)

Long life: LV + the number of cycles. ex: LV45 for 45.000 cycles. (others on request) LVXX: ex: LV45

9 - Cut Track – Open circuit.

Open circuit at beginning of track, fully CCW PCI

Open circuit at end of track, fully CW PCF

10 - Detents (DT)

One detent at the beginning DTI

One detent at the end DTF

X number of detents, evenly distributed. XDT: 10DT

Special detents are available on request: If you also need to assign a voltage value to each detent, please inquire.

11 - Terminals

SNAP IN P SNP

SNAP IN J SNJ

Shorter tip of terminal, TPXX, where XX is tip length (under request) TPXX, ex: TP25

12 - Housing

Color: For colors other than standard: -See color chart below- CJ-color, ex., red: CJ-RO

13 - Rotor

Color: For colors other than standard: -See color chart below- RT-color; ex., blue: RT-AZ

* Self-extinguishable property, V0, for housing and rotor:

By default, carbon is non self-extinguishable, cermet is Self-extinguishable: (blank)
For carbon: self-extinguishable property can be added. V0 means housing and rotor are V0. If only the housing needs to be V0, then CJ-V0. CJ-V0, RT-V0
If only rotor: RT-V0

14 - Wiper

Wiper position (Standard: 50% ± 15°) (leave blank)

Initial or CCW PI

Final or CW PF

Others: following clock positions; at 3 hours: P3H PXH, ex: P3H

Wiper torque (Standard: <2.5Ncm, for detents: <3.5) (leave blank)

Low torque, < 1.5Ncm PGB

15 - Linearity

Not controlled (leave blank)

Independent linearity controlled & below x%, for example, 3%: LN3% LNx%; ex: LN3%

Absolute linearity controlled & below x% LAx%

16 - Potentiometers with assembled accessories

Assembled from terminal side WT-

Accessory Reference (9019 or 9020) -XXXXX, Example: 9019

Color of shaft -YY Example, black: NE

Non self-extinguishable. (leave blank)

Self-extinguishable according to standard UL 94 -V0

(-V0 in box 17 modifies only the accessory, please, note.)

Color chart for rotor, housing and accessories

Black ⁽¹⁾	White	Neutral	Transp.	Red	Green	Yellow	Blue	Grey	Brown
NE	BA	IN	TA	RO	VE	AM	AZ	GS	MR

(1) black is not an option for housings.

Models

All models shown here have shaft 9020, but other shafts can be chosen from the list below (Page 71). The D dimension indicated on the drawings refers to the possible length of the shaft, to be chosen at "shafts" section. Potentiometers are sold separately from the nuts and washers.

H2,5

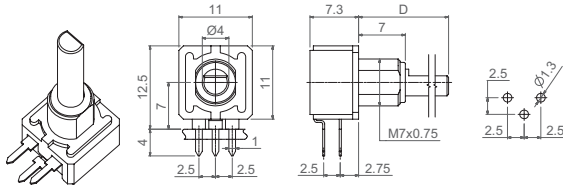

H3,8

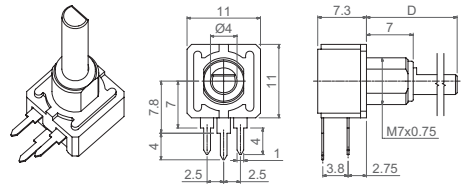

H5

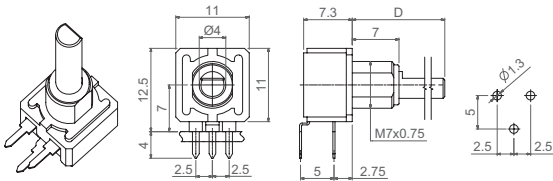

V7,5

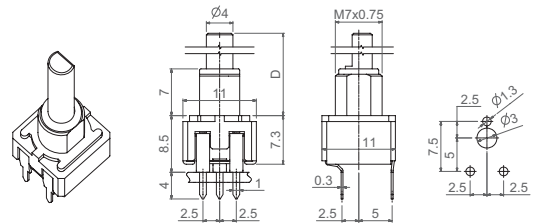

V10

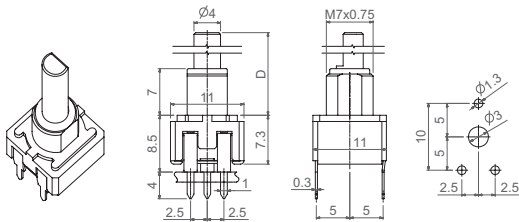

VK10

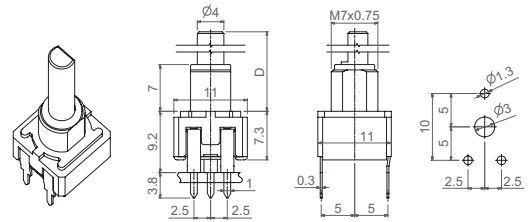

VR10

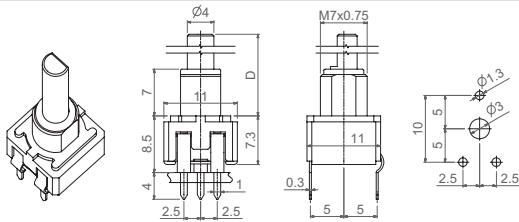

Nut

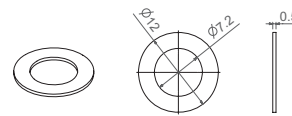

Washer



Nut and washer assembly indication

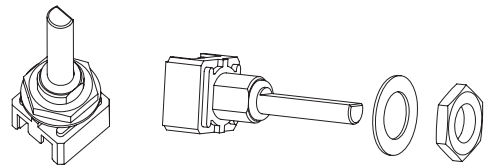

Tapers

The standard taper is linear (A). Log (B) and Antilog (C) tapers are also available, as well as special tapers according to customer's specifications. For example, a special taper can be matched with a potentiometer with detents (click effect), to guarantee a value in a specific position – see "detents" section.-

REGULAR TAPERS

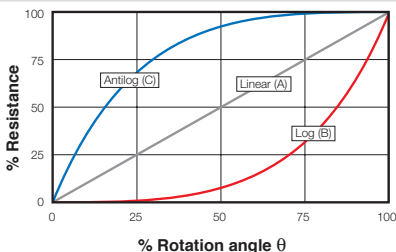

SPECIAL TAPERS

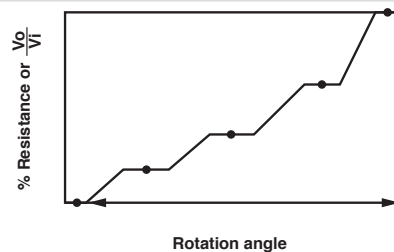

Potentiometers with cut track

The cut track is an area with very high resistive value, resulting in an open circuit. It is widely used in lighting applications. Mechanical life with cut track needs to be confirmed.
 PCI = Cut at initial position, when the potentiometer is turned fully counter clockwise.
 PCF = Cut at final position, when the potentiometer is turned fully clockwise.
 Other positions are available on request.

PCI

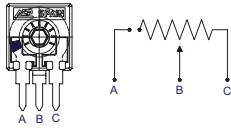

PCF

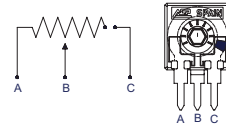

Potentiometers with detents

ACP's patented detent (DT) feature is especially suitable for control applications where the end user will turn a knob inserted in the potentiometer. Detents can be used to add a click feeling to the turning of the potentiometer or to control the position in which the wiper is placed, assuring a particular output value with a narrow tolerance.

Detents can be light or strong, or even a combination of different feelings. They can be evenly distributed along the angle (standard) or tailored to match customers' request. They can also be combined with special tapers: constant value areas, open circuit zone, different slopes, etc. One common example is a potentiometer with detents and matching non-overlapping voltage values in specific angular positions, used to feed in a voltage value to a microprocessor:

Example of 5DT with control of value in each DT.

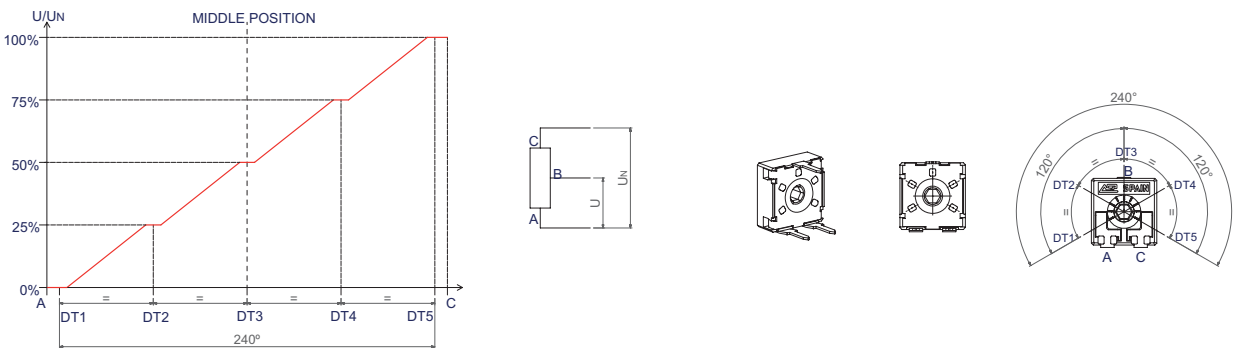

Other examples of potentiometers with detents:

10DT

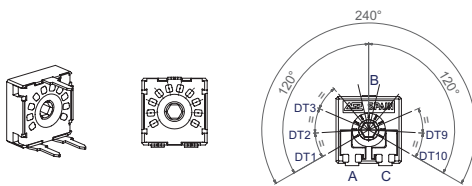

20DT

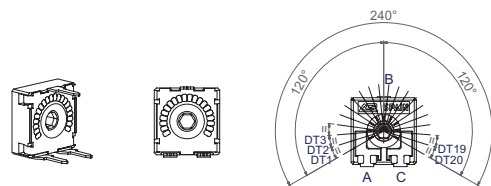

Number of standard detents (evenly distributed) already available.

1 (Initial, final or central), 2 DT (initial and final), 3, 4, 5, 6, 7, 8, 10, 20.

Maximum number of detents for feeling only

20

Maximum number of detents when the voltage value in each detent is controlled and non-overlapping.

10

Our patented design with two wipers has improved the performance of these potentiometers, giving them more stable electrical parameters, improved reliability and Contact Resistance Variation (CRV) as well as narrower tolerances for detent positioning.

For potentiometers with detents, mechanical life is also 1.000 cycles, if no additional cycles are mentioned. Please, indicate the number of cycles needed with LV (number of cycles), for example: LV07, for 7.000 cycles.

When needing a special number of detents or matching taper, a drawing is kindly requested.

Terminals

By default, terminals are always straight, as shown on the “models” section. ACP can provide crimped terminals (with snap in, “SNP” or “SNJ”), to better hold the component to the PCB during the soldering operation.

SNP

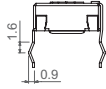

SNJ

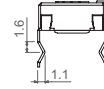

Also, there is an option of having shorter terminal tips:

Standard Terminal

Shorter terminal, for H5 TP25

Shorter terminal, TPXX (under request)

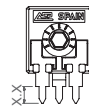
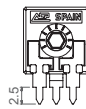
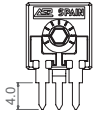

Possibilities for insertion of accessories

Should the shaft need to be positioned differently than shown on the “models” section on this catalogue, a drawing with the exact position is kindly requested.

Shafts

Shafts are available in different colors (color chart in “how to order” section) and with self-extinguishable property, according to UL 94 V-0, under request. ACP can study special shaft designs.

D dimension is the distance from the housing to the top of the shaft, as shown in the different models.

Shaft	9019	9020
D Dimension	17.5	23.5

9019

9020

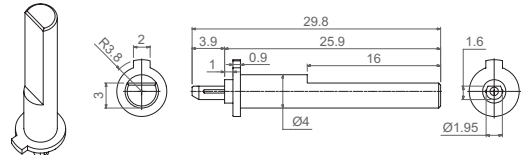
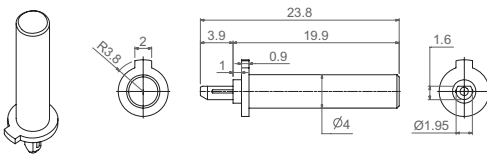

Packaging

Potentiometer model	With shaft or thumbwheel inserted?	Pieces per bigger box (250 x 150 x 70, CG on description)
H2,5 - H3,8 - H5 V7,5 - V10 - VK10 - VR10	9019, 9020	500

Electric Specifications

These are standard features; other specifications and out of range values can be studied on request.

	MCA9 Through-hole	MCE9 Through-hole
Range of resistance values* Lin (A) Log (B) Antilog (C)	100Ω ≤ Rn ≤ 5MΩ 1 KΩ ≤ Rn ≤ 2M2Ω	100Ω ≤ Rn ≤ 5MΩ 1 KΩ ≤ Rn ≤ 2M2Ω
Tolerance* Rn < 100Ω: 100Ω ≤ Rn ≤ 100KΩ 100K < Rn ≤ 1MΩ: 1MΩ < Rn ≤ 5MΩ: Rn > 5MΩ:	+50%, -30% (out of range) ±20% ±20% ±30% +50%, -30% (out of range)	- ±20% ±20% ±30% -
Variation laws	Lin (A), Log (B), Antilog (C). Other tapers available on request	
Residual resistance	Lin (A), Log (B), Antilog (C) ≤ 5*10 ⁻³ *Rn. Minimum value 2Ω	≤2Ω
CRV - Contact Resistance Variation (dynamic)	≤3%Rn	
CRV - Contact Resistance Variation (static)	≤5%Rn	
Maximum power dissipation** Lin (A) Log (B), Antilog (C)	at 50°C 0.15W 0.10W	at 70° C. 0.5W 0.20W
Maximum voltage Lin (A) Log (B), Antilog (C)	150VDC 200VDC	200VDC
Operating temperature	-25°C ... +70°C (+85°C on request)	-40°C ... +90°C (+125°C on request)
Temperature coefficient 100Ω ≤ Rn ≤ 10KΩ 10KΩ < Rn ≤ 5MΩ	+200/ -300 ppm +200/ -500 ppm	±100 ppm ±100 ppm

* Out of range ohm values and tolerances are available on request, please, inquire.

** Dissipation of special tapers will vary, please, inquire.

Mechanical Specifications

	MCA9 Through-hole	MCE9 Through-hole
Resistive element	Carbon technology	Cermet
Angle of rotation (mechanical)	240° ± 5°	
Angle of rotation (electrical)	220° ± 20°	
Wiper standard delivery position	50% ± 15°	
Max. stop torque	5 Ncm	
Max. push/pull on rotor	40 N	
Wiper torque*	<2 Ncm Potentiometers with detents: <2.5 Ncm	
Mechanical life	1.000 cycles (many more available on request, please, inquire)	

* Stronger or softer torque feeling is available on request.

Test results

The following typical test results are given at 23°C ±2°C and 50% ±25% RH.

	MCA9 Through-hole		MCE9 Through-hole	
	Test conditions	Typical variation of nominal resistance	Test conditions	Typical variation of nominal resistance
Damp heat	500 h. at 40°C and 95% RH	+5%, -2%	500 h. at 40°C and 95% RH	±2%
Thermal cycles	16 h at 85°C, plus 2 h at -25°C	±2.5%	16 h at 90°C, plus 2 h at -40°C	±2%
Load life	1.000 h. at 50°C	+0%; -6%	1.000 h. at 70°C	±2%
Mechanical life	1.000 cycles at 10 c.p.m. and at 23°C ± 2°C	±3%	1.000 cycles at 10 c.p.m. and at 23°C ± 2°C	±3%
Soldering effect	2 seconds at 350°C	±1%	2 seconds at 350°C	±1%
Storage (3 years)	3 years at 23°C ± 2°C	±3%	3 years at 23°C ± 2°C	±1%

MCA9 Through-hole

MCE9 Through-hole

Power derating curve:

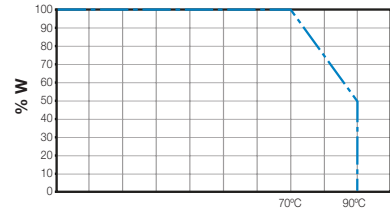
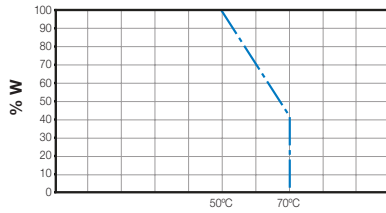

For temperatures out of range

The normal operation temperature for a carbon ACP potentiometer is -25°C to +70°C. When the temperature goes up to 85°C, the following variations should be observed:

Load life	1.000 h. at 50°C	+0%; -6%	1.000 h. at 85°C	+0%; -15%
-----------	------------------	----------	------------------	-----------

The power derating curve to consider is:

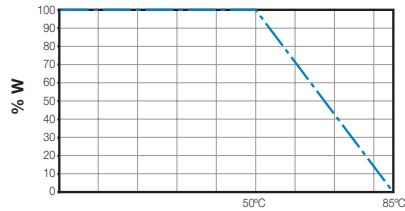

Representation of the typical variation of nominal resistance (with 95% confidence) throughout the ohm value range:

MCA9 Through-hole

MCE9 Through-hole

Damp heat

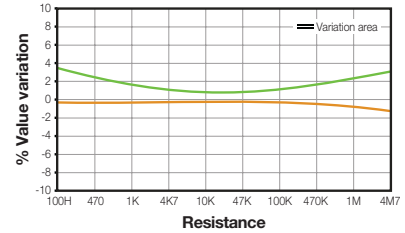
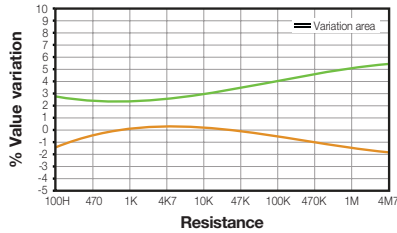

Temperature Coefficient

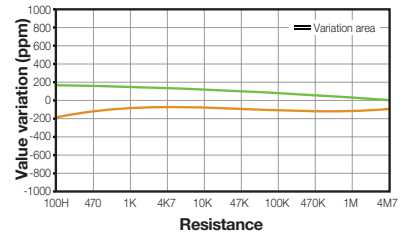
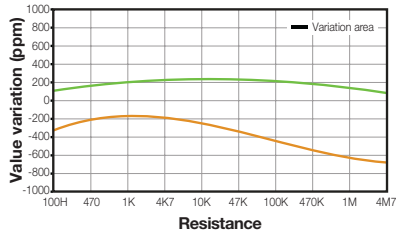

Load life

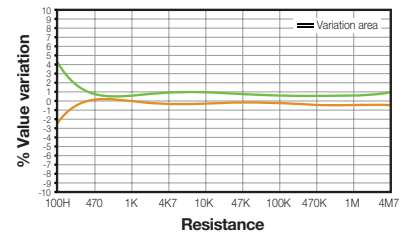
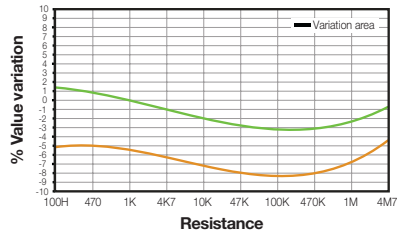

Mechanical life

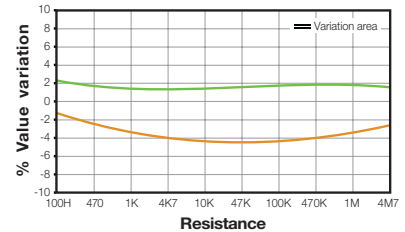
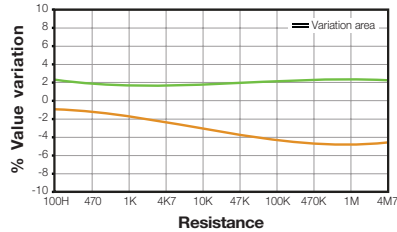

MCA9 MCE9

MCA14



Carbon Potentiometers CA

MCE14



Cermet Potentiometers CE



CARBON – MCA14

14mm carbon potentiometers with plastic enclosure and shaft.

Through-hole and SMD configurations are available. Terminals and collector are normally manufactured in tinned brass, although versions with steel terminals are also available under request. Terminals for through-hole models can be provided straight or crimped, which helps hold the component to the PCB during soldering.

Ingress Protection rating type IP 54 (high level of protection against dust and also against water splashing), according to IEC 60529. Plastic materials can be self-extinguishable according to UL 94 V-0 under request.

Tapers can be linear, log and antilog; special tapers can also be studied.

Potentiometers can be manufactured in a wide range of possibilities regarding:

- Resistance value.
- Tolerance.
- Tapers / variation laws.
- Pitch.
- Positioning of the wiper (standard is at 50% rotation).
- Housing and rotor color.
- Mechanical life.
- Click effect (up to 38 detents available).
- Self-extinguishable plastic parts according to UL 94 V-0.

Applications

14mm potentiometers are mainly used in control applications, in different markets:

- Electronic household appliances, heating, ventilation and air conditioning (HVAC) equipment, thermostats.

CERMET – MCE14

14mm cermet potentiometers with plastic enclosure and shaft. Cermet potentiometers have better thermal stability, allow for higher thermal dissipation and withstand higher temperatures than carbon potentiometers.

Through-hole and SMD configurations are available. Terminals and collector are manufactured in tinned brass, although versions with steel terminals are also available under request. Terminals for through-hole models can be provided straight or crimped, which helps hold the component to the PCB during soldering.

Ingress Protection rating type IP 54 (high level of protection against dust and also against water splashing), according to IEC 60529. Plastic materials (housing and rotor) are self-extinguishable according to UL 94 V-0 for ACP's cermet potentiometers.

Tapers can be linear, log and antilog; special tapers can also be studied.

Potentiometers can be manufactured in a wide range of possibilities regarding:

- Resistance value.
- Tolerance.
- Tapers / variation laws.
- Pitch.
- Positioning of the wiper (the standard is at 50%).
- Housing and rotor color.
- Mechanical life.
- Click effect (up to 38 detents available).

Applications

14mm cermet potentiometers are used in applications where either the operating temperature is high, or where the applications requires product with excellent ohmic value stability:

- Electronic appliances: boilers, water heaters.
- Industrial electronics: multimeters, oscilloscopes, time relays, measurement and test equipment.

MCA14 MCE14 HOW TO ORDER

EXAMPLE: **MCA14NH2,5-10KA2020 SNP PI WT-14187-BA**

EXAMPLE: **MCE14NH2,5-10KA2020 SNP PI WT-14187-BA-V0**

Standard features								Extra features							Assembled accessory			
Series	Rotor	Model	Packg.	Ohm value	Taper	Tol.	Life	Track	Detents	Snap in	Housing	Rotor	Wiper	Lin.	Assembly	Ref #	Color	Flam.
1	2	3	4	5	6	7	8	9	10	11	12	13	14	15	16			
MCA14																		
MCE14	N	H2,5		- 10K	A	2020				SNP			PI		WT	-14187	-BA	

Standard configuration:	MCA14 Through-hole	MCE14 Through-hole
Dimensions:	14mm	
Protection:	IP 54 (dust-proof) On request: Self-extinguishable, to meet UL 94 V-0	
Substrate:	Carbon technology	Cermet
Color:	Blue housing + white rotor	Brown housing + white rotor
Packaging:	Bulk	
Wiper position:	at 50% ±15°	
Terminals:	Straight, without crimping.	
Marking:	Resistive value marked on housing. Others on request.	

Customized products: A drawing is requested when ordering a customized product. Series, rotor, model and total resistive value are indicated before the code that includes all special specifications. Example: MCA14PH2,5-10K CODE C00111. Other features could be available on request, please, ask.

1 - Series

■ MCA14 ■ MCE14

2 - Rotors

N Z

3 - Model and pitch

H0	HC0	H2,5	H4	H5	HA5	HL5	V12,5
VA12,5	VL12,5	VR12,5	V15	VJ15	V17,5	VD7,5	VD11

4 - Packaging

Bulk (blank)...⁽¹⁾

5 - Resistance value

100Ω 200Ω 220Ω 250Ω 470Ω 500Ω 1KΩ 2KΩ ... 500KΩ 1MΩ 2MΩ 2M2Ω 4M7Ω 5MΩ

100 200 220 250 470 500 1K 2K 500K 1M 2M 2M2 4M7 5M

6 - Resistance law / taper

Lin - Linear	A
Log - Logarithmic	B
Antilog - Antilogarithmic	C
- Special tapers have codes assigned:	CODE YXXXXX

7 - Tolerance

±20%	±30%	+50%,-30%	±10%	±5%
2020	3030	5030	1010	0505

8 - Operating Life (Cycles)

Standard (1.000 cycles) (leave blank)
Long life: LV + the number of cycles. ex: LV45 for 45.000 cycles. (others on request) LVXX: ex: LV45

9 - Cut Track – Open circuit.

Open circuit at beginning of track, fully CCW	PCI
Open circuit at end of track, fully CW	PCF

10 - Detents (DT)

One detent at the beginning	DTI
One detent at the end	DTF
X number of detents	XDT: 10DT

Special detents are available on request: If you also need to assign a voltage value to each detent, please inquire.

11 - Terminals

SNAP IN P	SNP
SNAP IN R	SNR
Shorter tip of terminal, TPXX, where XX is tip length (under request)	TPXX, ex: TP30

12 - Housing

Color: For colors other than standard: -See color chart below- CJ-color, ex., red: CJ-RO

13 - Rotor

Color: For colors other than standard: -See color chart below- RT-color; ex., blue: RT-AZ

* Self-extinguishable property, V0, for housing and rotor:

By default, carbon is non self-extinguishable, cermet is Self-extinguishable: (blank)
For carbon: self-extinguishable property can be added. V0 means housing V0
and rotor are V0. If only the housing needs to be V0, then CJ-V0. CJ-V0, RT-V0
If only rotor: RT-V0

14 - Wiper

Wiper position (Standard: 50% ± 15°)	(leave blank)
Initial or CCW	PI
Final or CW	PF
Others: following clock positions; at 3 hours: P3H	PXH, ex: P3H
Wiper torque (Standard: <2.5Ncm, for detents: <3.5)	(leave blank)
Low torque, < 1.5Ncm	PGB

15 - Linearity

Not controlled	(leave blank)
Independent linearity controlled & below x%, for example, 3%: LN3%	LNx%; ex: LN3%
Absolute linearity controlled & below x%	LAX%

16 - Potentiometers with assembled accessories

Assembled from terminal side	WT
Accessory Reference	-XXXXX
See list of shafts and thumbwheels available	Example: 14187
Color of shaft or thumbwheel	-YY Example, white: BA
Non self-extinguishable. Self-extinguishable according to standard	(leave blank)
UL 94 (-V0 in box 17 modifies only the accessory, please, note.)	-V0

Color chart for rotor, housing and accessories

Black ⁽¹⁾	White	Neutral	Transp.	Red	Green	Yellow	Blue	Grey	Brown
NE	BA	IN	TA	RO	VE	AM	AZ	GS	MR

(1) black is not an option for housings.

All models shown here have shaft 14187, but other shafts can be chosen from the list below. The D dimension indicated on the drawings refers to the possible length of the shaft, to be chosen at "shafts" section. Potentiometers are sold separately from the nuts and washers.

H0

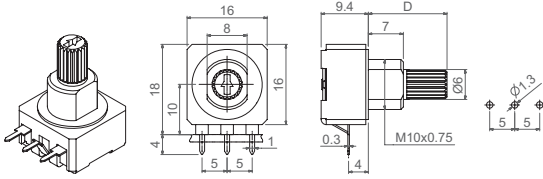

HC0

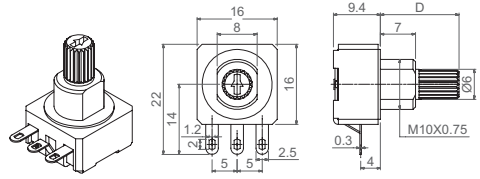

H2,5

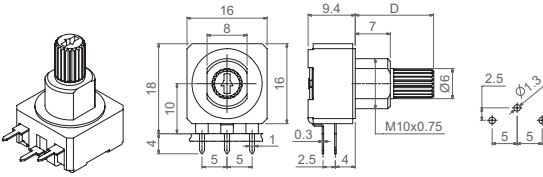

H4

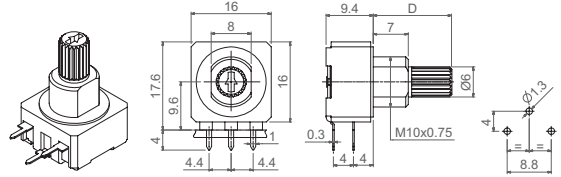

H5

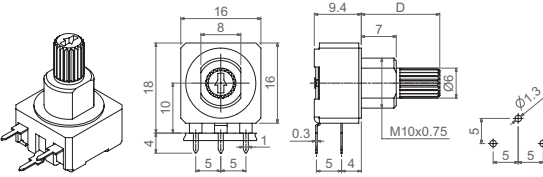

HA5

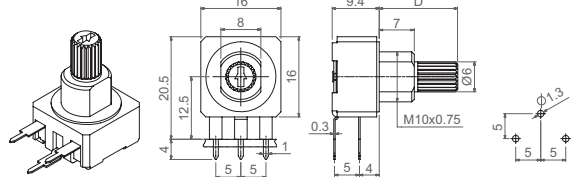

HL5

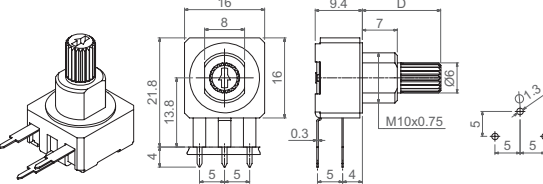

V12,5

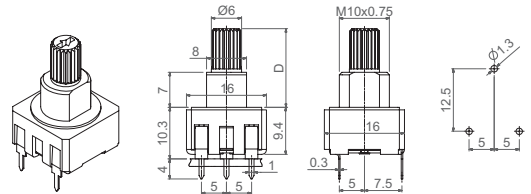

VA12,5

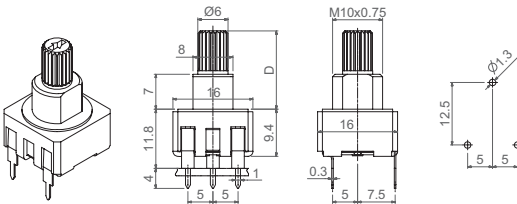

VL12,5

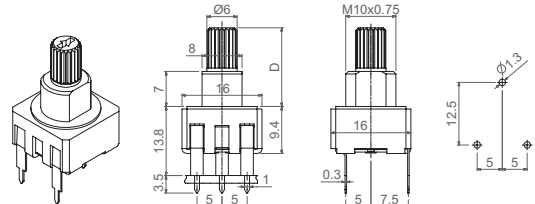

VR12,5

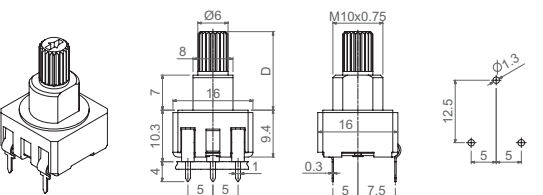

V15

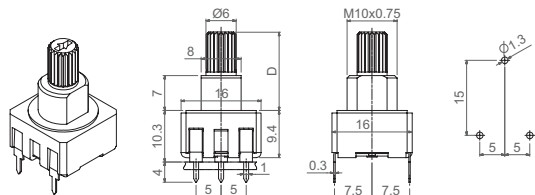

VJ15

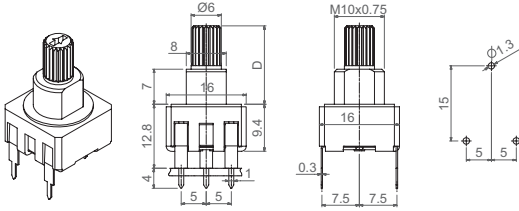

V17,5

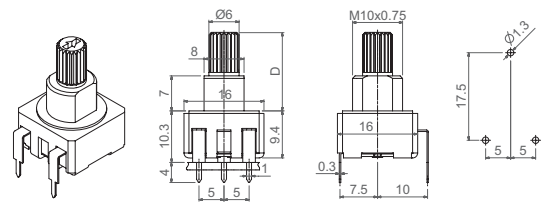

VD7,5

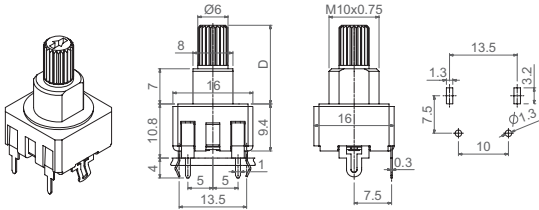

VD11

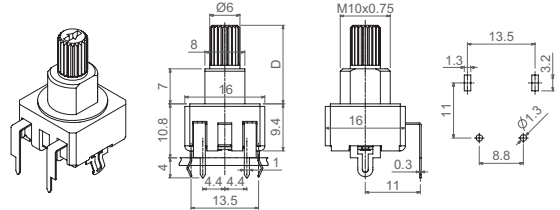

Nut

Washer

Nut and washer assembly indication

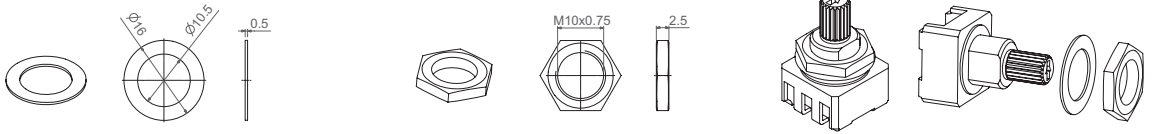

Tapers

The standard taper is linear (A). Log (B) and Antilog (C) tapers are also available, as well as special tapers according to customer's specifications. For example, a special taper can be matched with a potentiometer with detents (click effect), to guarantee a value in a specific position – see "detents" section.-

REGULAR TAPERS

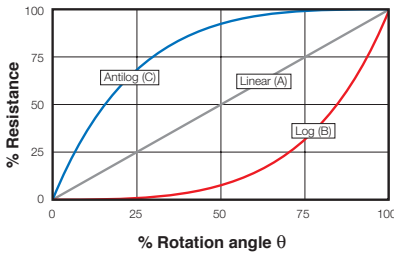

SPECIAL TAPERS

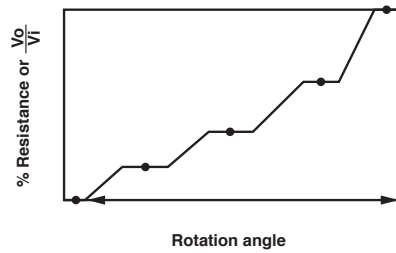

Potentiometers with cut track

The cut track is an area with very high resistive value, resulting in an open circuit. It is widely used in lighting applications. Mechanical life with cut track needs to be confirmed.
 PCI = Cut at initial position, when the potentiometer is turned fully counter clockwise.
 PCF = Cut at final position, when the potentiometer is turned fully clockwise.
 Other positions are available on request.

PCI

PCF

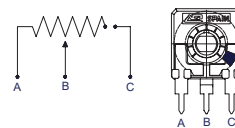
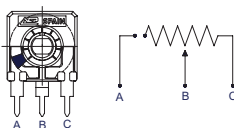

Potentiometers with detents

ACP's patented detent (DT) feature is especially suitable for control applications where the end user will turn a knob inserted in the potentiometer. Detents can be used to add a click feeling to the turning of the potentiometer or to control the position in which the wiper is placed, assuring a particular output value with a narrow tolerance.

Detents can be light or strong, or even a combination of different feelings. They can be evenly distributed along the angle (standard) or tailored to match customers' request. They can also be combined with special tapers: constant value areas, open circuit zone, different slopes, etc. One common example is a potentiometer with detents and matching non-overlapping voltage values in specific angular positions, used to feed in a voltage value to a microprocessor:

Example of 5DT with control of value in each DT.

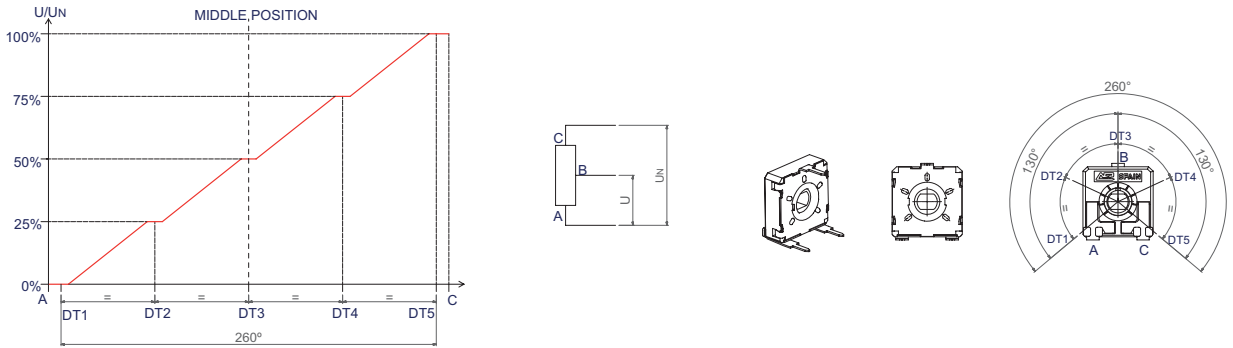

Examples of some potentiometers with detents:

14DT

38DT

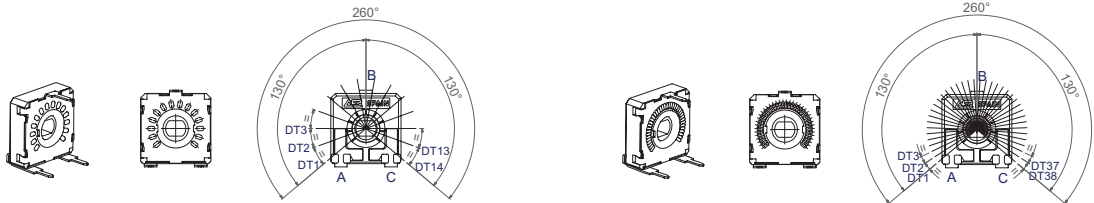

Number of standard detents (evenly distributed) already available.	1 (Initial, final or central), 3, 4, 5, 6, 7, 8, 9, 10, 13, 14, 17, 22, 27, 38.
Maximum number of detents for feeling only	38
Maximum number of detents when the voltage value in each detent is controlled and non-overlapping.	14

Our patented design with two wipers has improved the performance of these potentiometers, giving them more stable electrical parameters, improved reliability and Contact Resistance Variation (CRV) and narrower tolerances for detent positioning.

For potentiometers with detents, mechanical life is also 1.000 cycles if no additional cycles are mentioned. Up to 10.000 cycles are available. Please, indicate the number of cycles needed with LV (number of cycles), for example: LV10, for 10.000 cycles.

When needing a special number of detents or matching taper, a drawing is kindly requested.

Terminals

By default, terminals are always straight, as shown on the “models” section. ACP can provide crimped terminals (with snap in, “SNP” or “SNR”), to better hold the component to the PCB during the soldering operation.

SNP

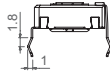

SNR

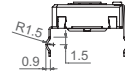

Also, there is an option of having shorter terminal tips:

Standard Terminal

Shorter terminal, for V12,5 TP30

Shorter terminal, TPXX (under request)

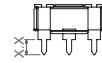

Adjustment and orientation

Should the shaft need to be positioned differently than shown on the “models” section on this catalogue, a drawing with the exact position is kindly requested.

Shafts

Shafts are available in different colors (color chart in “how to order” section) and with self-extinguishable property, according to UL 94 V-0, under request. ACP can study special shaft designs.

D dimension is the distance from the housing to the top of the shaft, as shown in the different models.

Shaft	14081	14187	14067	14008	14015	14066	14084	14250	14072	14073
D Dimension	15.2	15.7	24.7	20.2	20.2	20.45	20.45	21.95	28.7	35.45

14008

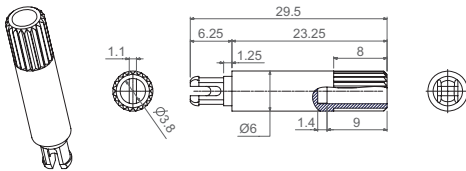

14015

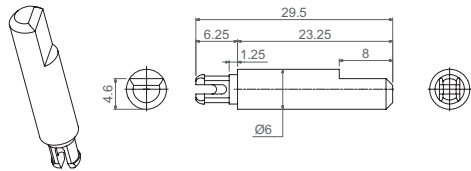

14066

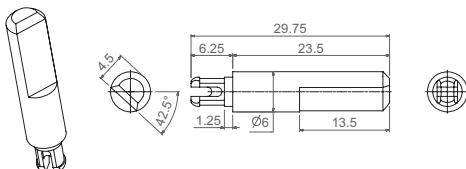

14067

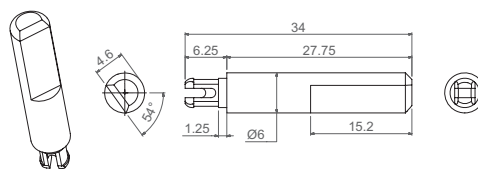

Shafts

14072

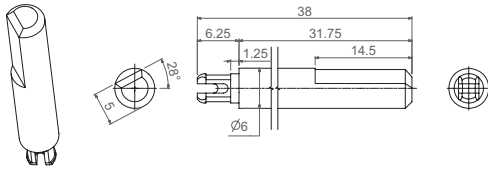

14073

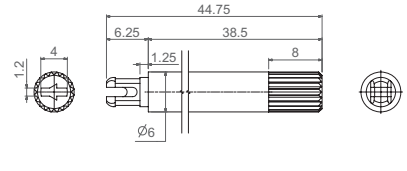

14081

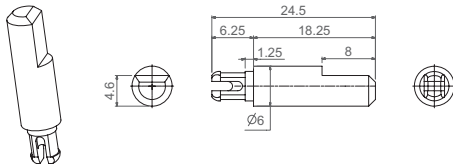

14084

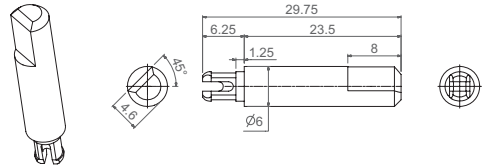

14187

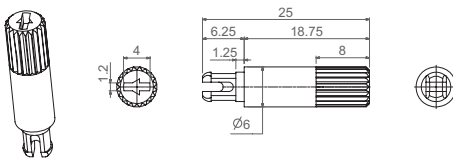

14250

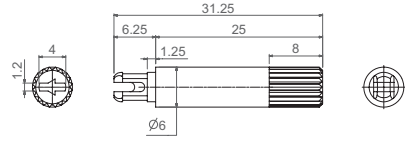

Packaging

Potentiometer model	With shaft or thumbwheel inserted?	Pieces per bigger box (250 x 150 x 70, CG on description)
H0 - HC0 - H2,5 - H4 - H5 - HA5 - HL5 V12,5 - V15 - VA12,5 - VL12,5 - VR12,5 VJ15 - V17,5 - VD11 - VD7,5	With any shaft.	150

Electric Specifications

These are standard features; other specifications and out of range values can be studied on request.

	MCA14 Through-hole	MCE14 Through-hole
Range of resistance values* Lin (A) Log (B) Antilog (C)	100Ω ≤ Rn ≤ 5MΩ 1 KΩ ≤ Rn ≤ 2M2Ω	100Ω ≤ Rn ≤ 5MΩ 1 KΩ ≤ Rn ≤ 2M2Ω
Tolerance* Rn < 100Ω: 100Ω ≤ Rn ≤ 100KΩ: 100K < Rn ≤ 1MΩ: 1MΩ < Rn ≤ 5MΩ: Rn > 5MΩ:	+50%, -30% (out of range) ±20% ±20% ±30% +50%, -30% (out of range)	- ±20% ±20% ±30% -
Variation laws	Lin (A), Log (B), Antilog (C). Other tapers available on request	
Residual resistance	Lin (A), Log (B), Antilog (C) ≤ 5*10 ⁻³ *Rn. Minimum value 2Ω	≤2Ω
CRV - Contact Resistance Variation (dynamic)	≤3%Rn	
CRV - Contact Resistance Variation (static)	≤5%Rn	
Maximum power dissipation** Lin (A) Log (B), Antilog (C)	at 50°C 0.25W 0.13W	at 70°C. 0.7W 0.30W
Maximum voltage Lin (A) Log (B), Antilog (C)	250VDC 200VDC	
Operating temperature	-25°C ... +70°C (+85°C on request)	-40°C ... +90°C (+125°C on request)
Temperature coefficient 100Ω ≤ Rn ≤ 10KΩ 10KΩ < Rn ≤ 5MΩ	+200/ -300 ppm +200/ -500 ppm	±100 ppm ±100 ppm

* Out of range ohm values and tolerances are available on request, please, inquire.

** Dissipation of special tapers will vary, please, inquire.

Mechanical Specifications

	MCA14 Through-hole	MCE14 Through-hole
Resistive element	Carbon technology	Cermet
Angle of rotation (mechanical)	265° ± 5°	
Angle of rotation (electrical)	245° ± 20°	
Wiper standard delivery position	50% ± 15°	
Max. stop torque	10 Ncm	
Max. push/pull on rotor	50 N	
Wiper torque*	<2.5 Ncm Potentiometers with detents: <3.5 Ncm	
Mechanical life	1.000 cycles (many more available on request, please, inquire)	

* Stronger or softer torque feeling is available on request.

Test results

The following typical test results (with 95% confidence) are given at 23°C ±2°C and 50% ±25% RH.

	MCA14 Through-hole		MCE14 Through-hole	
	Test conditions	Typical variation of Rn	Test conditions	Typical variation of Rn
Damp heat	500 h. at 40°C and 95% RH	+5%, -2%	500 h. at 40°C and 95% RH	±2%
Thermal cycles	16 h at 85°C, plus 2 h at -25°C	±2.5%	16 h at 90°C, plus 2 h at -40°C	±2%
Load life	1.000 h. at 50°C	+0%; -5%	1.000 h. at 70°C	±2%
Mechanical life	1.000 cycles at 10 c.p.m. and at 23°C ± 2°C	±3%	1.000 cycles at 10 c.p.m. and at 23°C ± 2°C	±2%
Soldering effect	2 seconds at 350°C	±1%	2 seconds at 350°C	±1%
Storage (3 years)	3 years at 23°C ± 2°C	±3%	3 years at 23°C ± 2°C	±1%

MCA14 Through-hole

MCE14 Through-hole

Power derating curve:

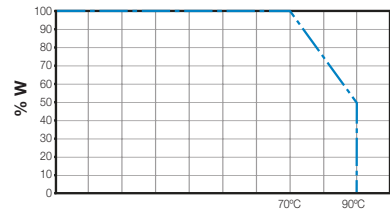
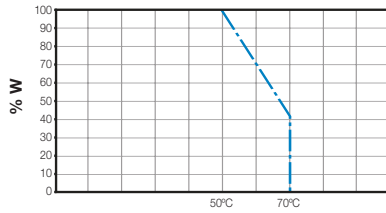

For temperatures out of range

The normal operation temperature for a carbon ACP potentiometer is -25°C to +70°C. When the temperature goes up to 85°C, the following variations should be observed:

Load life	1.000 h. at 50°C	+0%; -6%	1.000 h. at 85°C	+0%; -15%
-----------	------------------	----------	------------------	-----------

The power derating curve to consider is:

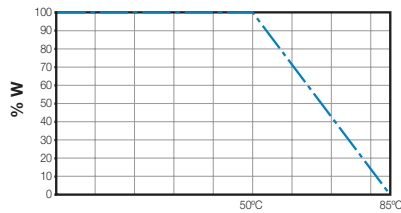

Representation of the typical variation of nominal resistance (with 95% confidence) throughout the ohm value range:

MCA14 Through-hole

MCE14 Through-hole

Damp heat

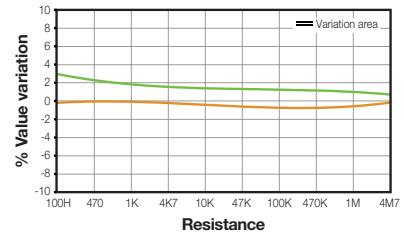
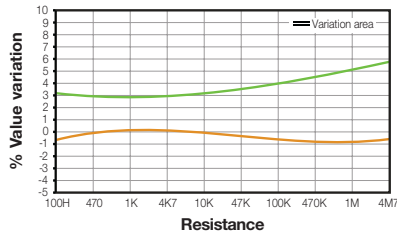

Temperature Coefficient

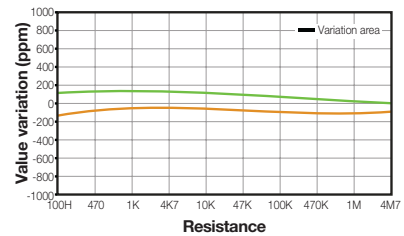
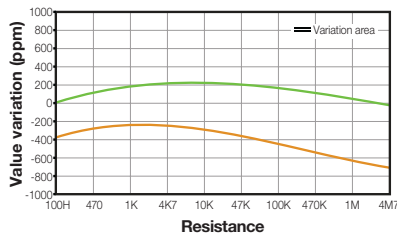

Load life

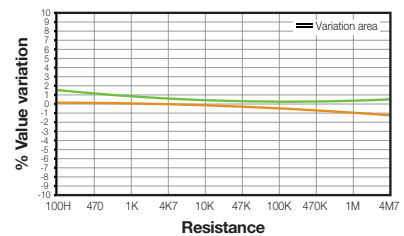
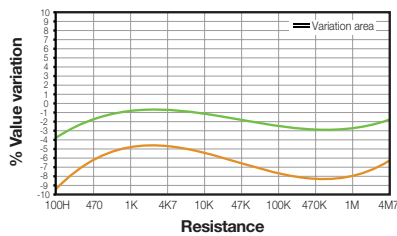

Mechanical life

