



**N. MICRO**

**S.A.R.L.**

Meeting & Serving the needs of OEMs in Lebanon & the region since 1996.

# Introduction of our Company:

- ① *We are distributors of electronic components, power supply units, industrial & home automation, electrical panels, PV & UPS systems, batteries...*
- ① *We provide complete turnkey solutions and maintenance for Industrial automated control systems, Photovoltaic backup and remote power systems.*
- ① *We design, program and prototype electronic circuits*

# Employees

- ◎ Our team consists of 12 employees:
- ◎ General Manager
- ◎ Sales Manager
- ◎ Two HR & Accounting
- ◎ Three Engineers
- ◎ Stock Manager
- ◎ Two drivers for deliveries
- ◎ One outside sales
- ◎ Two loaders

# Our Branches



Beirut, Dora Branch



Zahle Beqaa Branch

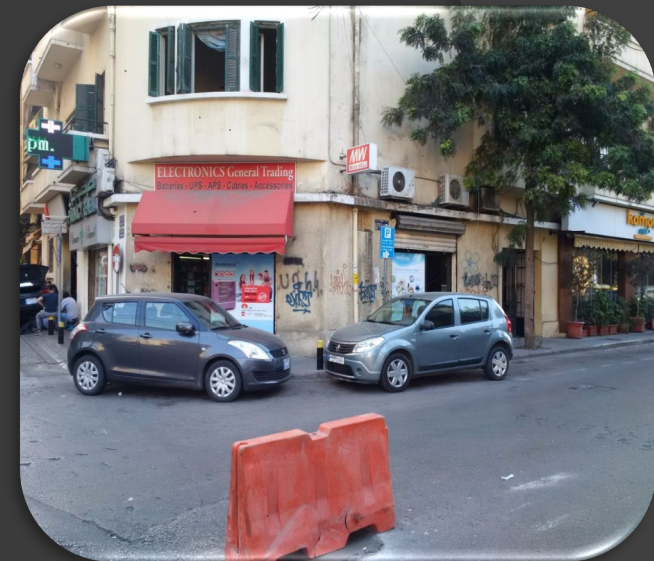

Beirut Mar Michael Branch

# SOME OF OUR BRANDS



- Power Supplies, Battery chargers, Backup systems
- LED Power supplies.



**MICROCHIP**

- Microcontrollers.

The logo for ema, featuring the letters 'ema' in a stylized yellow font with a registered trademark symbol.

- Industrial sensors and switches.



- Terminal blocks, connectors.

The logo for HONGFA, featuring the letters 'HF' in red inside a blue circle, with 'HONGFA' in blue below it.

- Relays.



- Far Infrared Heaters

The logo for LSIS, featuring the letters 'LSIS' in blue and grey with a red arrow pointing to the 'S'.

- Programmable Logic Controllers
- Variable frequency drives

The logo for invvt, featuring the letters 'invvt' in blue with a red dot above the 'i'.

- UPS backup systems
- Solar variable frequency drives

The logo for MikroElektronika, featuring a red square with a white 'e' and the word 'MikroElektronika' in red, with 'DEVELOPMENT TOOLS | COMPILERS | BOOKS' in smaller text below.

- Electronics development tools.

The logo for BroadLink, featuring the word 'BroadLink' in blue with a stylized 'B' and 'L'.

- Home Automation.

The logo for EMEB, featuring a yellow 'E' in a blue square followed by 'EMEB' in blue with a registered trademark symbol.

- Batteries.



# High Reliability Standard Switching Power Supply

— one stop shopping for all the power you need —



LED Power Solution



Medical Power Solution

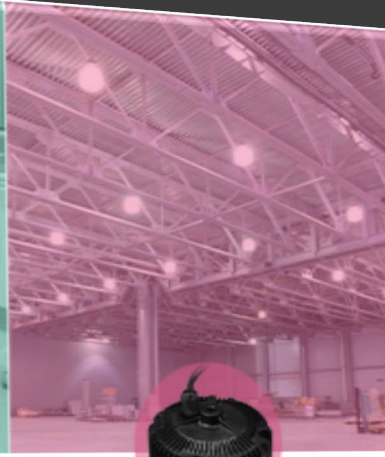

High Bay Lighting  
Power Solution

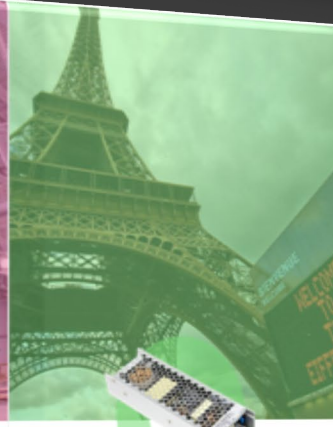

LED Display Power  
Solution



Green Energy Power  
Solution



Burn-in Equipments  
Power Solution



# Drive Solutions

LSIS offers drive solutions that can achieve reduction in energy consumption significantly.



Low Voltage VFD



Medium Voltage VFD



Softstarter



PLC



Remote I/O



HMI



Servo Drive & Motor  
(XGT Servo System)

**new** **LS IS**  
**Solar Pump Drive**

Voc range : 240~800VDC

Power : 0.4~500kWp



**Integrated MPPT (Maximum Power Point Tracking)**

MPPT algorithm enables you to extract best power from your solar panel under all conditions. It tracks the maximum output power available from the solar panel during the day and automatically adjust them for the most optimal utilization of solar energy.

**Answer for optimal off-grid solution**

From irrigation of fields to remote villages or isolated places, solar pump system can be well suited to satisfy the water pumping demand. It is perfect and flexible option for power source.

**Advanced time control**

Scheduling (Time event: Real Time Clock) functionality makes possible for the solar drive system to star and stop automatically based on radiation condition of the sun.

**All-round protection**

Protection specified for pumps such as dry run, pipe broken, pump overload prevents any possible pump damages ensuring the system run safe and reliable.

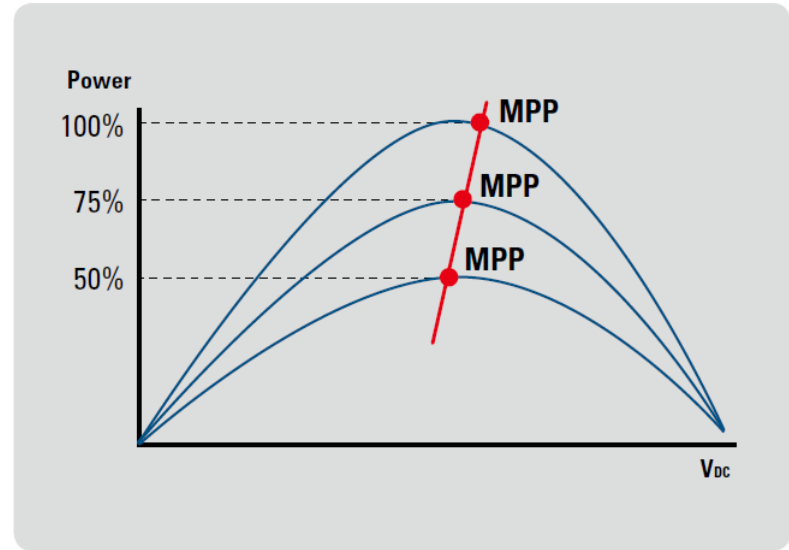

**Solar water pump system**

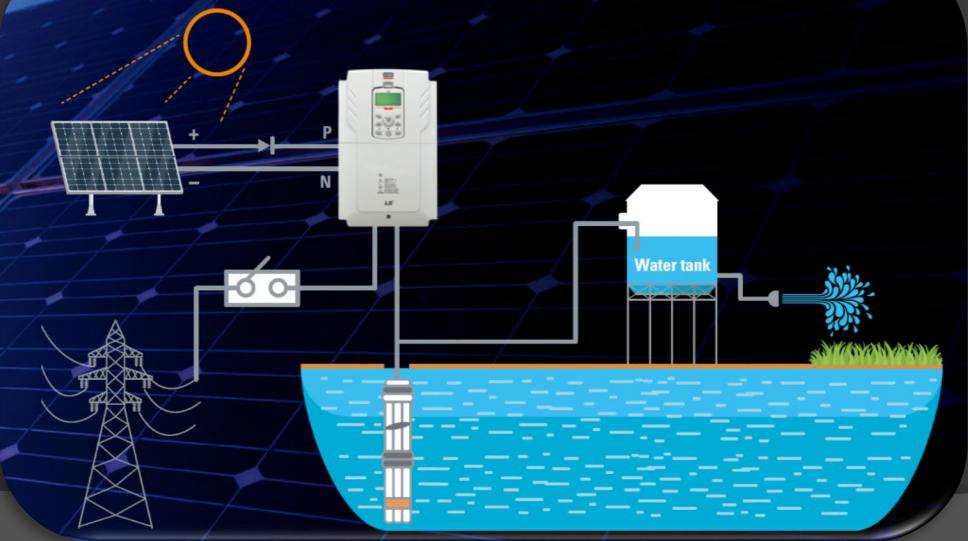

*Let your Drive turn Light into Power!*



**Cost Saving**

*It immediately reduces or even eliminates the cost from electrical grid and protects your business against future power price rises.*



**Low Labor**

*Automatic control depending on solar energy availability enables unmanned control and requires little to no maintenance.*



**Eco Friendly**

*This renewable energy does not produce air pollutants without emitting CO<sub>2</sub>.*





Model name	NH-200 NH-200F	NH-290 NH-290F	NH-300 NH-300F	NH-600 NH-600F	NH-800 NH-800F
Fuel type	Diesel	Diesel	Diesel	Diesel	Diesel
Fuel Consumption L/h	0.9	1.2	1.4	1.7	2.3
Heat Output (kcal/h)	8,000kcal	11,000kcal	13,000kcal	16,000kcal	21,000kcal
Rated Voltage	AC220V/50Hz	AC220V/50Hz	AC220V/50Hz	AC220V/50Hz	AC220V/50Hz
Power Consumption	50W/90W	56W/96W	57W/97W	57W/97W	70W/110W
Dimensions (WxDxH)	760x320x930 (355)	760x320x1080 (355)	940x320x1080 (355)	1300x320x1100 (355)	1300x320x1270 (355)
Fuel tank capacity	25 ℓ	25 ℓ	30 ℓ	45 ℓ	45 ℓ
Exhaust diameter	Ø75mm	Ø75mm	Ø100mm	Ø100mm	Ø100mm
Weight	37kg/39kg	44kg/46kg	53kg/55kg	60kg/62kg	65kg/67kg

### Basic Model

NH-200  
NH-290  
NH-300  
NH-600  
NH-800

### With Fan Model

NH-200F  
NH-290F  
NH-300F  
NH-600F  
NH-800F

# Professional Pumping Systems

# DUKSHIN



<b>MANUAL</b> 	<b>BATTERY</b> 	<b>DRUM</b> 	<b>CHEMICAL</b> 
<b>ELECTRIC</b>  12-24V DC	<b>WATER</b> 	<b>ACCESSORIES</b> 	<b>OTHERS</b> 



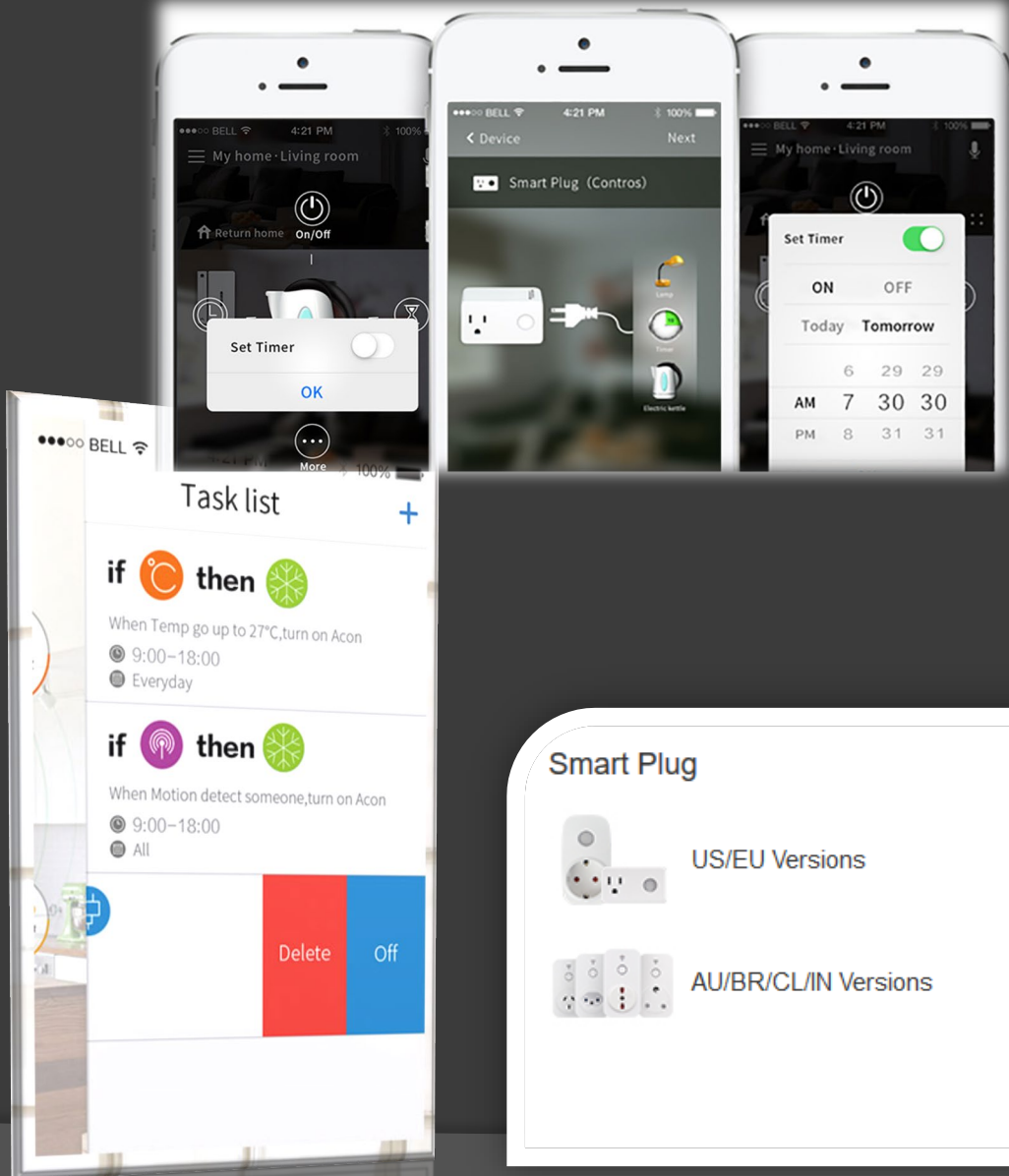

# Smart Universal Remote Control

One button to control all appliances (TV, Air-conditioning, Motor Curtain, etc.)

Wi-Fi universal remote | RM Pro



## Smart Plug



US/EU Versions



AU/BR/CL/IN Versions

## Universal Remote



IR Control



IR+RF Control



RM pro 433MHz

## Sensors



Alarm Kit



Environment Sensor

## Light Switch



US/EU/UK Versions

Delete Off

# Roller Shutter & Curtain Motors Window Actuators

**DOOYA Radio** **RM: Radlo With Manual**  
Mechanic Limit + Built-in Receiver + Manual **Ø45**

For more design options, please contact our sales consultant.

Outlook

Usage

Motorized Awning

Motorized Roller Shutter

Dimension drawing

Inner structure picture

LIMIT SWITCH RECEIVER CAPACITOR MOTOR BRAKE GEARBOX

Motor Head

Bracket: DZ198

427# LIMIT SWITCH

40.3mm

DC90  
More emitters are available  
See page 43

Tubular Motor Nameplate  
**DM 45 RM -- 40 / 15**

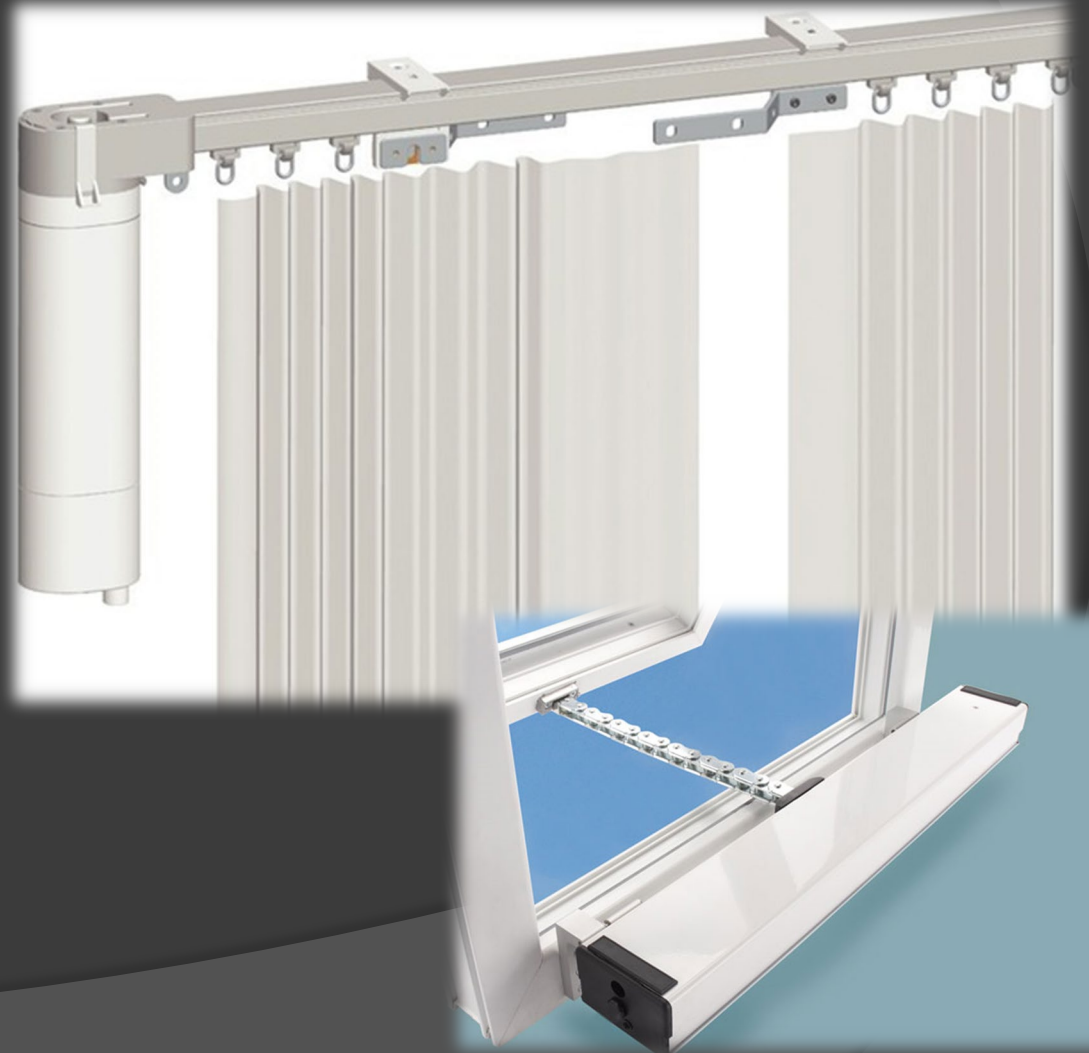

TUBULAR MOTOR DM45EAB

CASING BOX

CROWN DH05

END CAP DZ167D

GUIDER DS245-01

MOTOR BRACKET DZ264

LINE - THREADING BRACKET DS245-03

SIDE PLATE DZ304A

ANTI - UPWARD PEDRAIL DS202

BEARING DS265-02

IDLER DW56

DRIVING TUBE

DRIVE ADAPTER DL04

METAL ROLLER SHEET

TRACK

ANTI - MOVEMENT BRACKET DS245-05

BOTTOM BEAM

Pushbutton Switch DC2600



### Relays

- Signal Relay
- Power Relay
- Latching Relay
- Automotive Relay
- Industrial Relay
- Relay Socket
- Hermetically Sealed Relay
- Relay Socket



**DEGSON**®

Terminal Blocks & Precise Moulds  
ISO9001 ISO14001 ISO80079-34  
UL US Ex CE ENEC CQC ROHS REACH

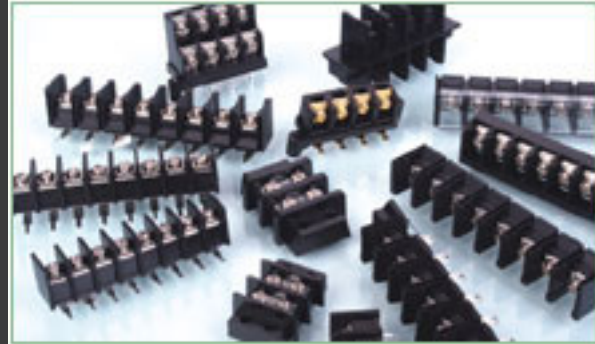
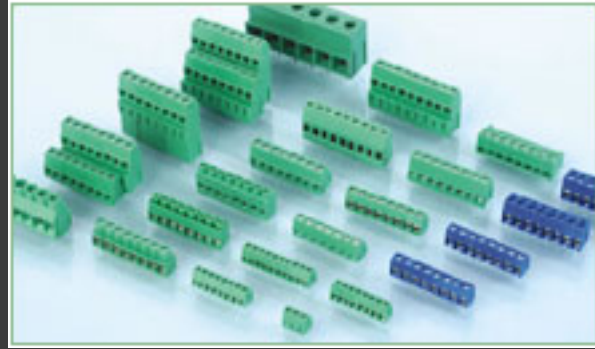

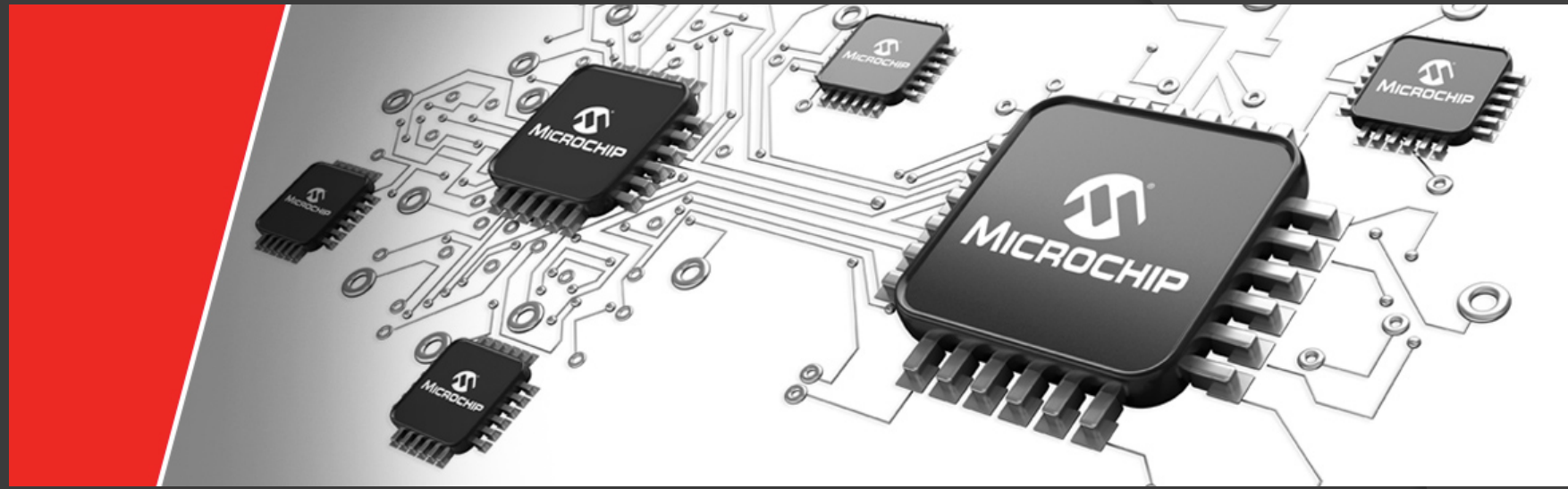

**Microchip microcontrollers,  
development kits and peripheral ICs.**

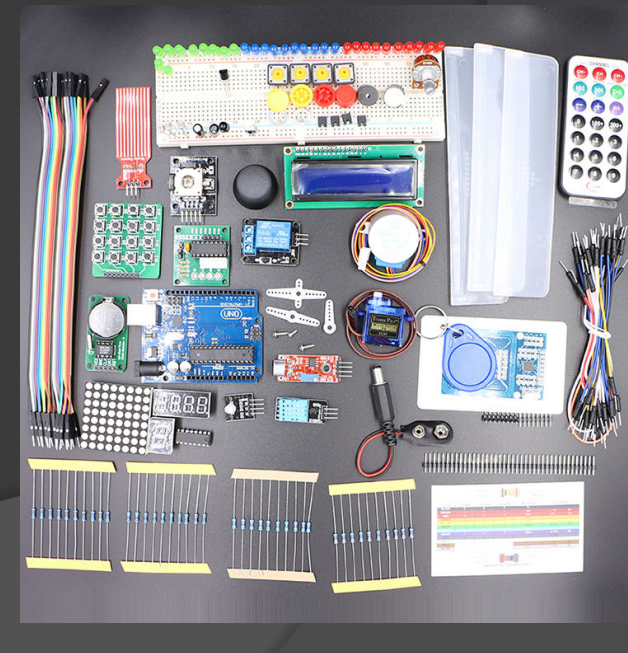
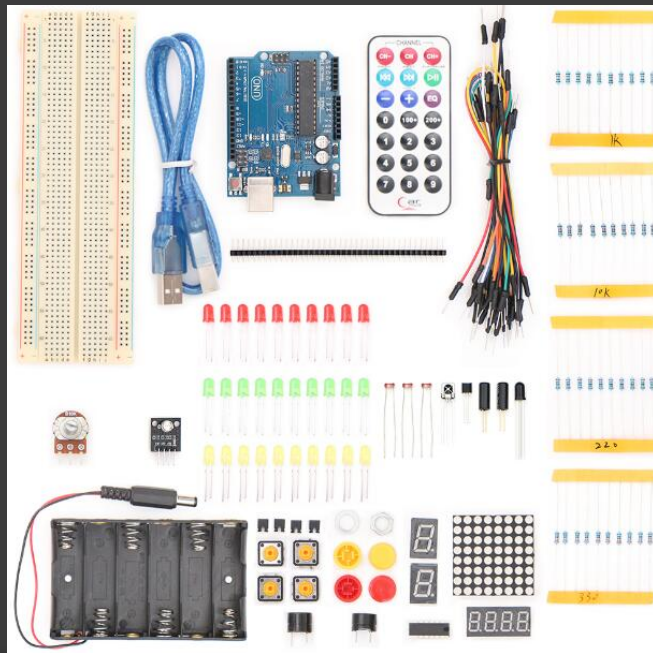
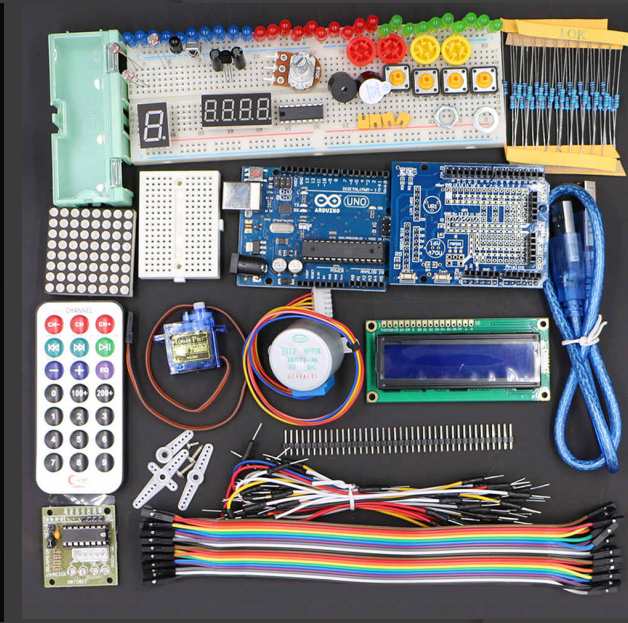
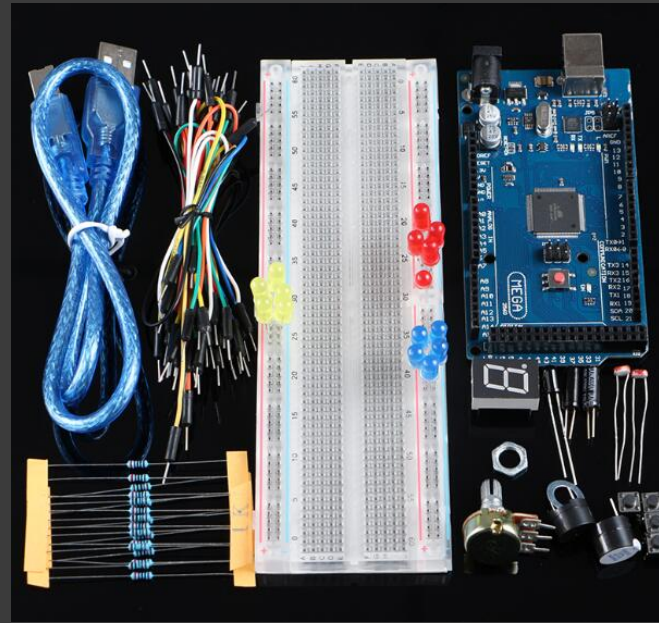
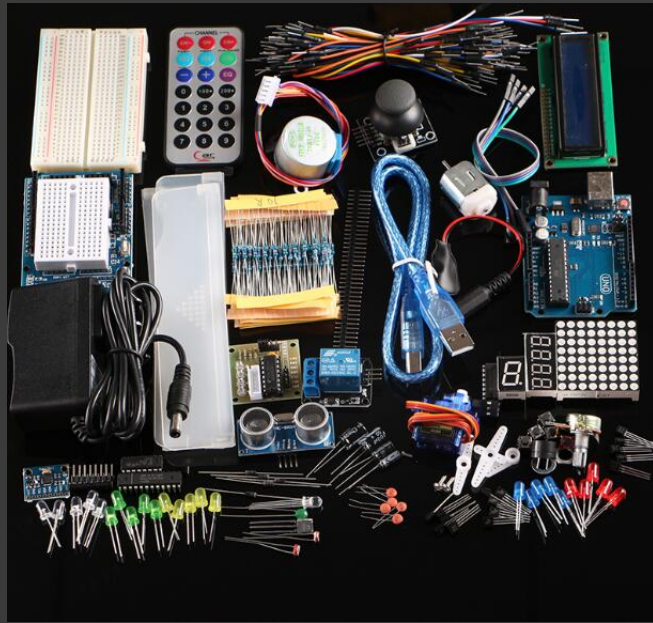



# Online sinewave UPS

Internal battery & External battery long backup time models

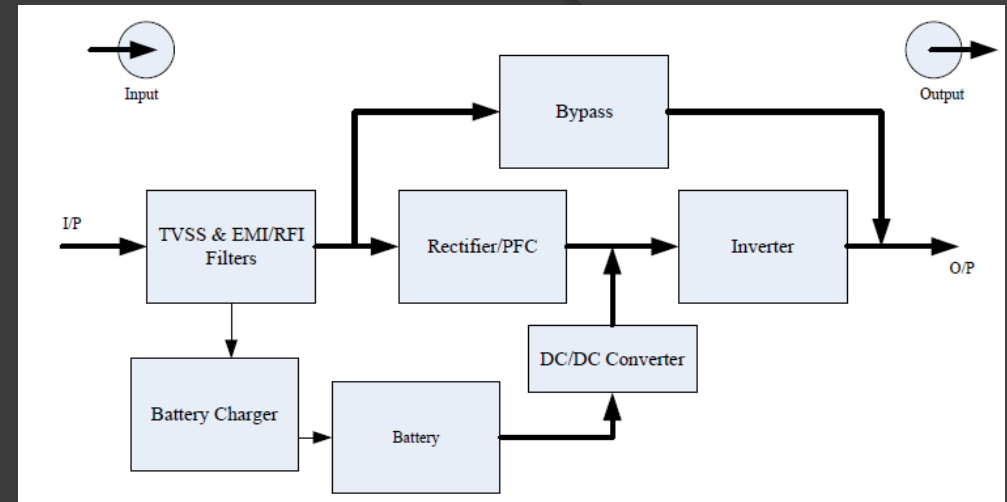

6 – 20KVA



1 – 3KVA



# POWTRAN

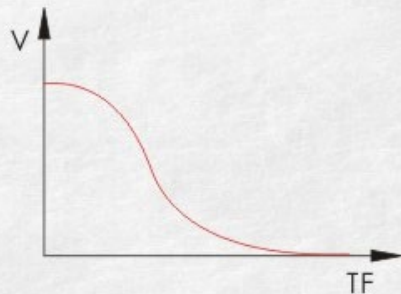

## Soft stop function

Soft stop function efficiently solve the stop of inertial systems.

Surge problem: It can not be realized by traditional starting device.A

## PR5200<sup>series</sup>

### High-quality Soft starter



**PR5200** series soft starter, with the newest motor control theory and proprietary motor protection technology, it's an alternative products of old star delta conversion, auto-induction voltage-reduced starting and Excitation step-down device.

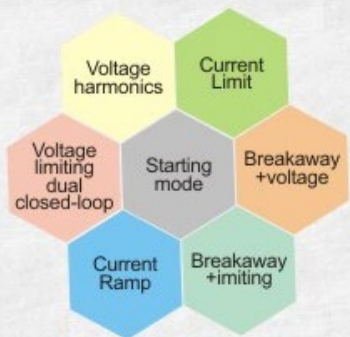

## Multi-Mode Start

6 kinds of special start model: To suit complicated motor and load situation.

# Braking resistors

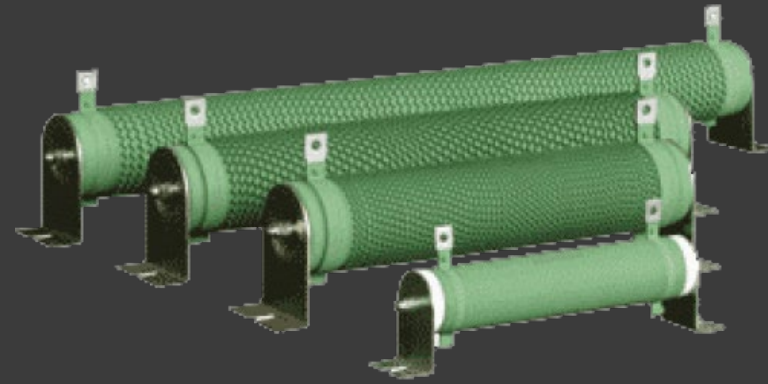

# Solar Panels and accessories



# Primary Batteries

# maxell



Silver Oxide

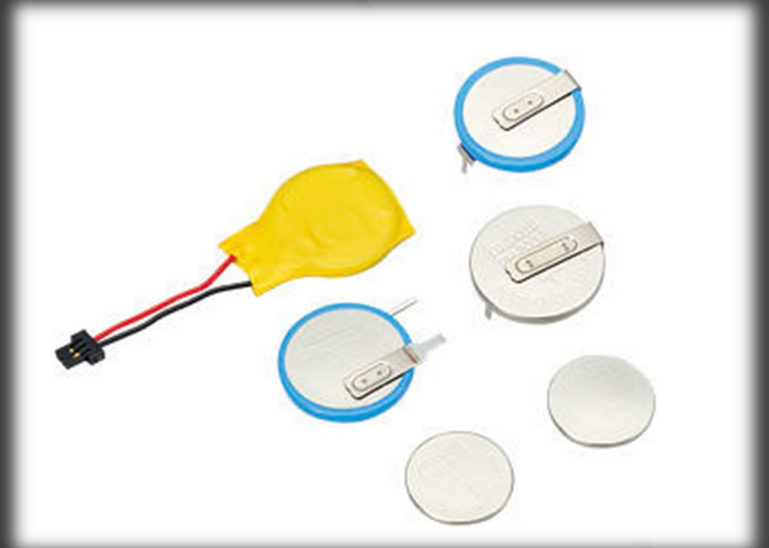

Lithium

# GoldenPower®



Alkaline

# EEMB®



# Rechargeable Batteries



Flooded lead acid deep-cycle



Ni-MH Ni-Cd



Sealed lead acid deep-cycle



Li-ion  
Li-Polymer

# Panel Enclosures

**B&J**<sup>®</sup>



# Switches

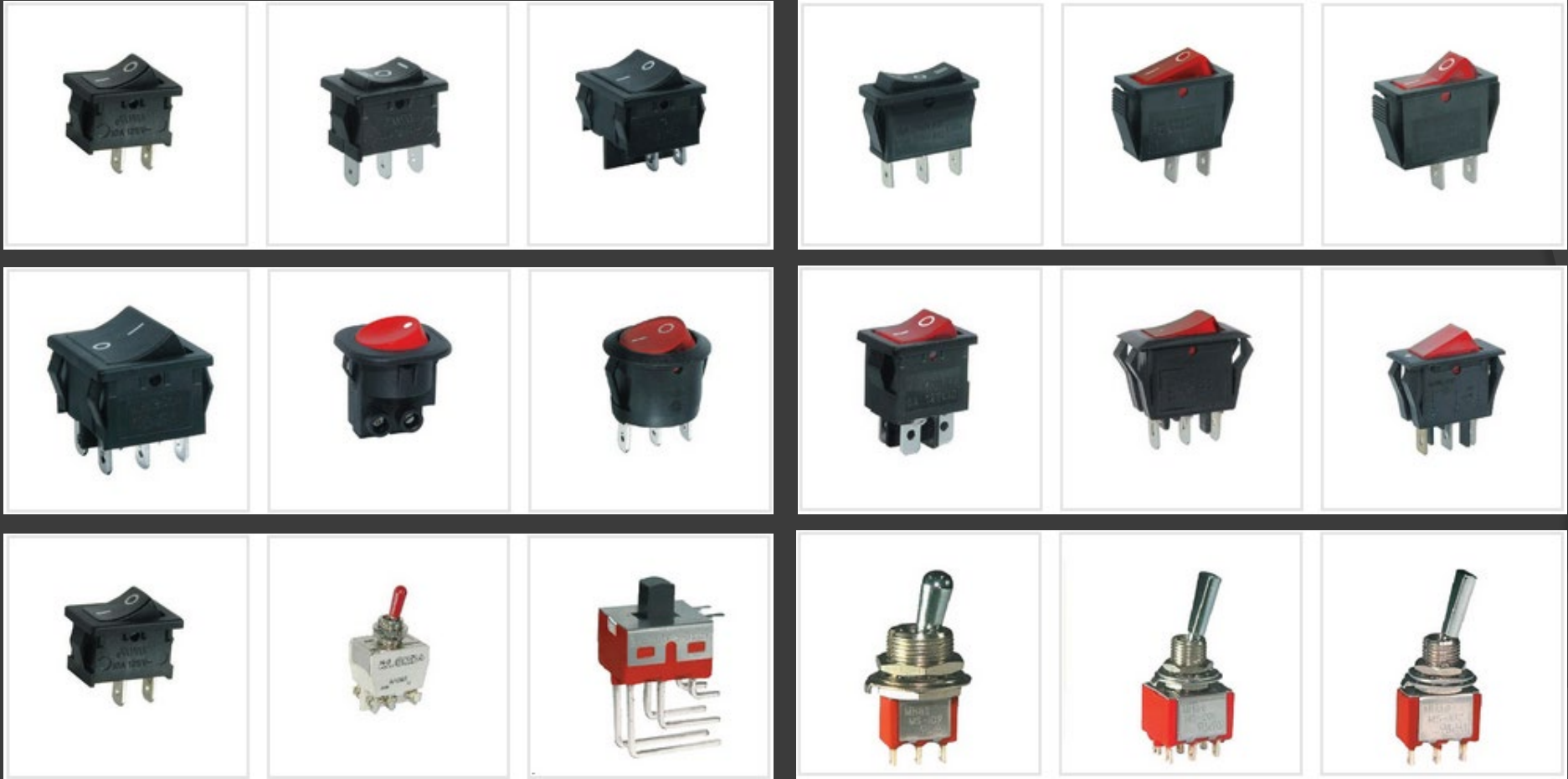



# Diptronics

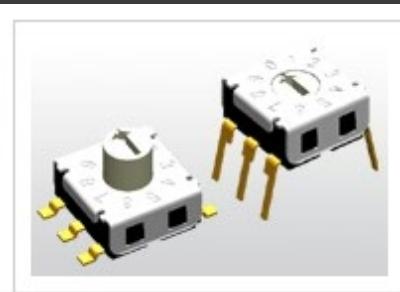
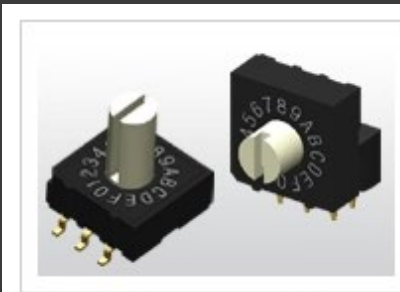
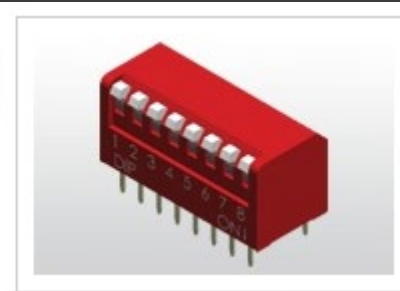
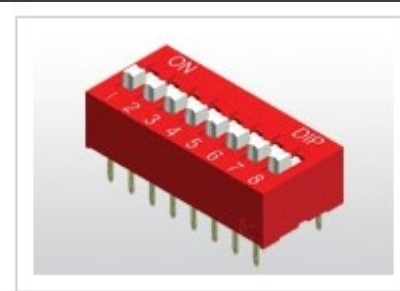
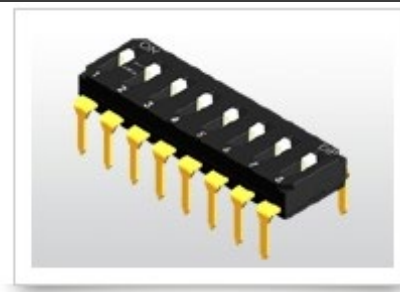
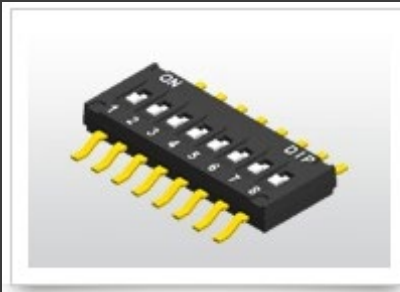
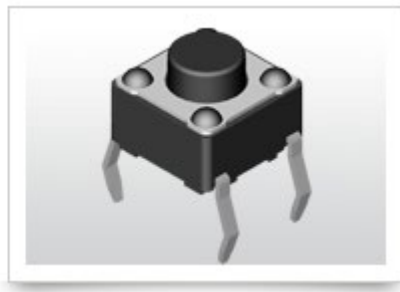
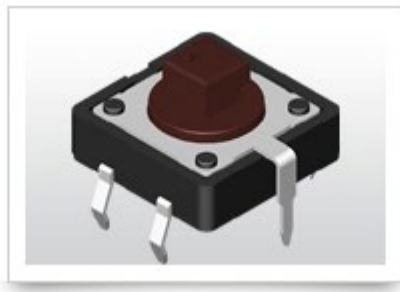
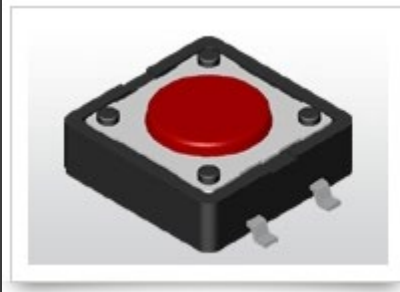

# Universal Programmers



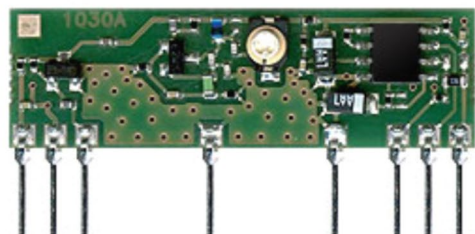

- ✓ Modulation: ASK (AM)
- ✓ Supply: 5V
- ✓ Frequency: 433.92 MHz
- ✓ Sensitivity: -106 dBm
- ✓ Consumption: 2.5 mA
- ✓ Dimension: 38.1 x 12.3 x 3 mm



- ✓ Modulation: ASK (AM)
- ✓ Supply: 3V
- ✓ Frequency: 433.92 MHz
- ✓ Sensitivity: -100 dBm
- ✓ Consumption: 0.07 mA
- ✓ Dimension: 40.1 x 17.5 x 5.5 mm

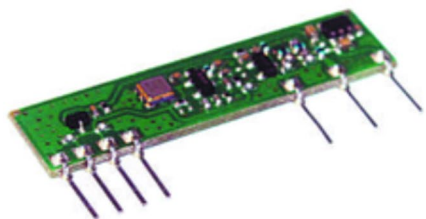

- ✓ Modulation: ASK (AM)
- ✓ Supply: 3 ÷ 12V
- ✓ Frequency: 433.92 MHz
- ✓ Consumption: 7.5 mA
- ✓ ERP Power: 10 mW
- ✓ Dimension: 38.1 x 11 x 3 mm



- ✓ Modulation: ASK (AM)
- ✓ Supply: 3V
- ✓ Frequency: 433.92 MHz
- ✓ Consumption: 25 mA
- ✓ ERP Power: 10 mW
- ✓ Dimension: 56 x 18.5 x 8 mm



- ✓ Modulation: FSK (FM) PLL
- ✓ Supply: 3V
- ✓ Frequency: 433.92 MHz
- ✓ Consumption: 14 mA
- ✓ ERP Power: 10 mW
- ✓ Dimension: 25.4 x 12.4 x 2.5 mm

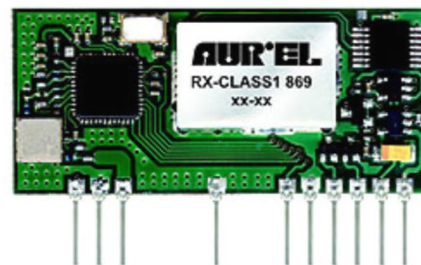

- ✓ Superheterodyne
- ✓ Modulation: FSK (FM)
- ✓ Supply: 3÷5.5 V
- ✓ Frequency: 869.2125 / 869.2375 MHz
- ✓ Sensitivity: -115 dBm
- ✓ Consumption: 40 mA
- ✓ Dimension: 45.7 x 20 x 3.5 mm

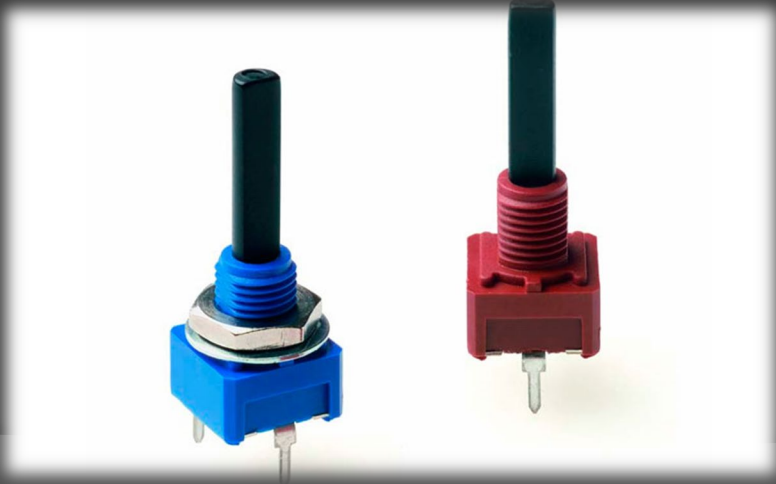
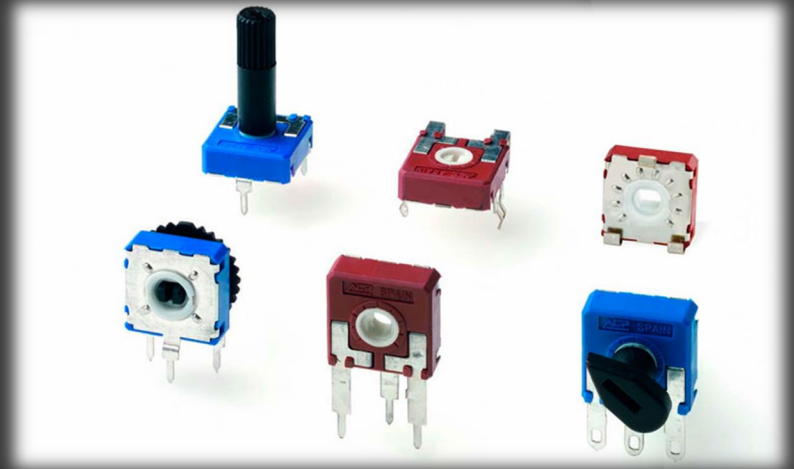
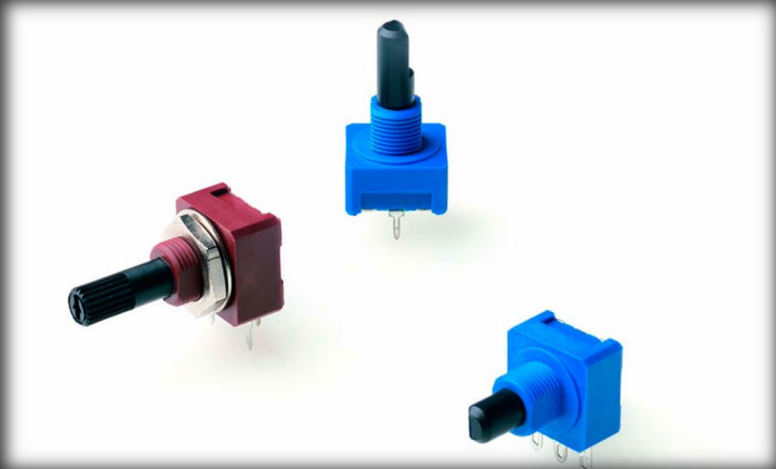
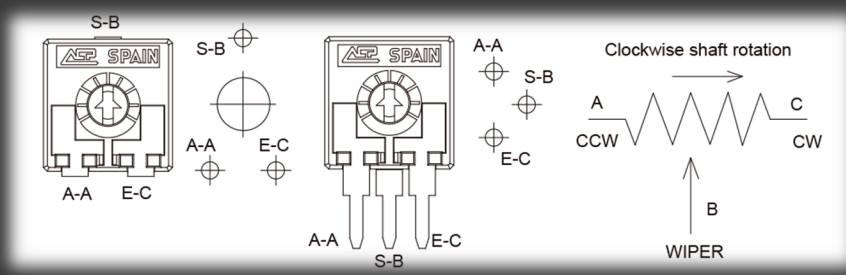



# Programmable Relays





# DC and AC Fans





杰美康机电  
JUST MOTION CONTROL

## Digital stepper driver and motor

Digital Driver with built-in micro technology, much improve smooth and noise from the low subdivision .

Integrating automatic parameter tuning function inside.

Can adjust the optimal operation parameters automatically for different motors to maximize the performance of the motor.





SHENMAO Technology Inc.

▪ SMT Assembly

- ☐ Tin Lead Solder Paste
- ☐ Lead-Free Solder Paste
- ☐ Water Soluble Solder Paste
- ☐ Package on Package Solder Paste
- ☐ Low Temperature Solder Paste
- ☐ Halogen Free Solder Paste
- ☐ Adhesive

▪ Wave Solder Assembly

- ☐ Solder Bar
- ☐ Cored Solder Wire
- ☐ Lead Free Solder Wire
- ☐ Halogens Free Solder Wire







### Applications:

#### Monorail / Electric Chain Hoist:



SAGA1-L4



SAGA1-L6



SAGA1-L8



SAGA1-L6B



SAGA1-L8B



SAGA1-L10,  
L10-1

#### Tower Crane:



SAGA1-10,  
L10-1



SAGA1-K1,K2



SAGA1-K3,K4



SAGA1-L12,  
L12-1



SAGA1-L40

#### Overhead Crane:



SAGA1-L8B



SAGA1-L10,  
L10-1



SAGA1-L12,  
L12-1



SAGA1-K1,K2



SAGA1-K3,K4



SAGA1-L40

#### Tow Truck:



SAGA1-L4  
(DC TYPE)



SAGA1-L6  
(DC TYPE)



SAGA1-L8  
(DC TYPE)



SAGA1-V6  
(DC TYPE)

#### Concrete Mixer:



SAGA1-L4  
(DC TYPE)



SAGA1-L6  
(DC TYPE)



SAGA1-L8  
(DC TYPE)



SAGA1-V6  
(DC TYPE)

#### Lifting Equipment:



SAGA1-L4  
(DC TYPE)



SAGA1-L6  
(DC TYPE)



SAGA1-L8  
(DC TYPE)



SAGA1-V6  
(DC TYPE)



Flow Sensors



Pressure Sensors



Capacitive Proximity Sensors



22/25/30mm Control Switches



30/50/70mm Multi-Layer Light Tower



Ultrasonic Level Transmitter



Rotating Paddle Level Switches



Vibrating Fork Level Switches



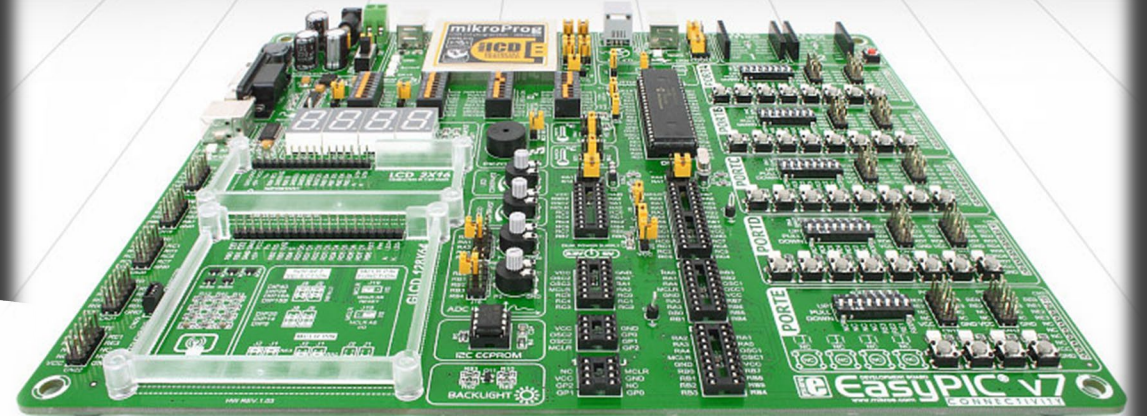

## Add-On Boards

We have an arsenal of accessory boards for almost everything you need. If you have a development system, we provide the easiest way to expand it's functionality in many segments. Add wireless communication, real-time clocks, storage interface, displays, measurement sensors, audio signalization, and much more with our accessory boards. We offer Proto boards, IDC10 header compatible boards and Click Boards™ built for mikroBUS™ pinout standard.



Click Boards (257)

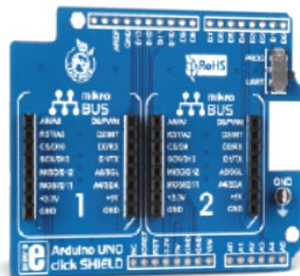

click shields (12)

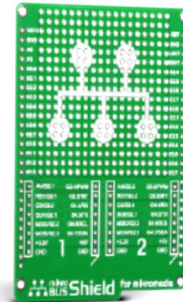

mikromedia shields (8)

wikromedia shields (8)

# Some of our projects:



Cement Factory Control Panel & Automation with Billing & Remote Access

# WEIGHING AND PACKING MACHINE CONTROL PANEL WIRING AND PLC PROGRAMMING



# WEIGHING AND PACKING MACHINE:

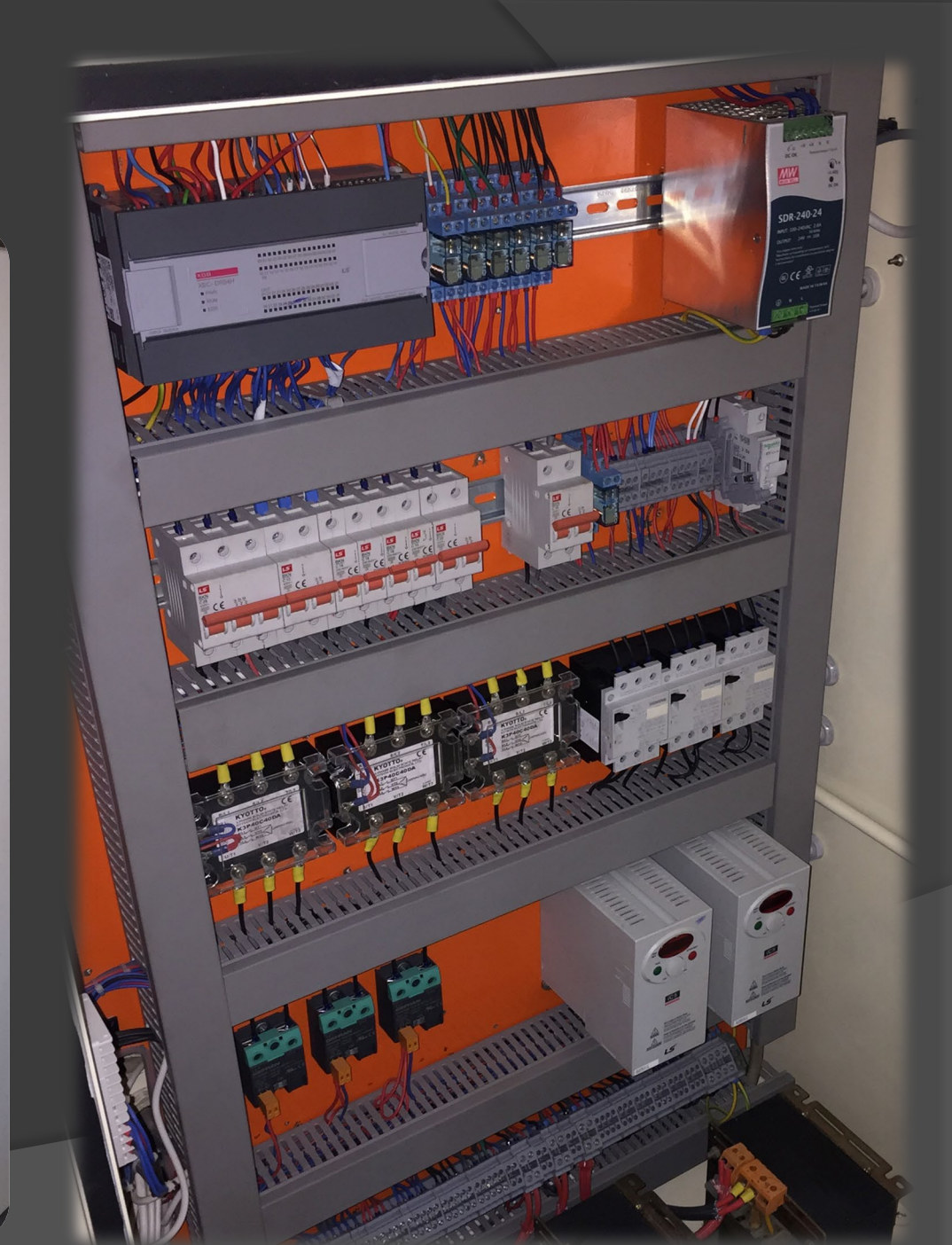
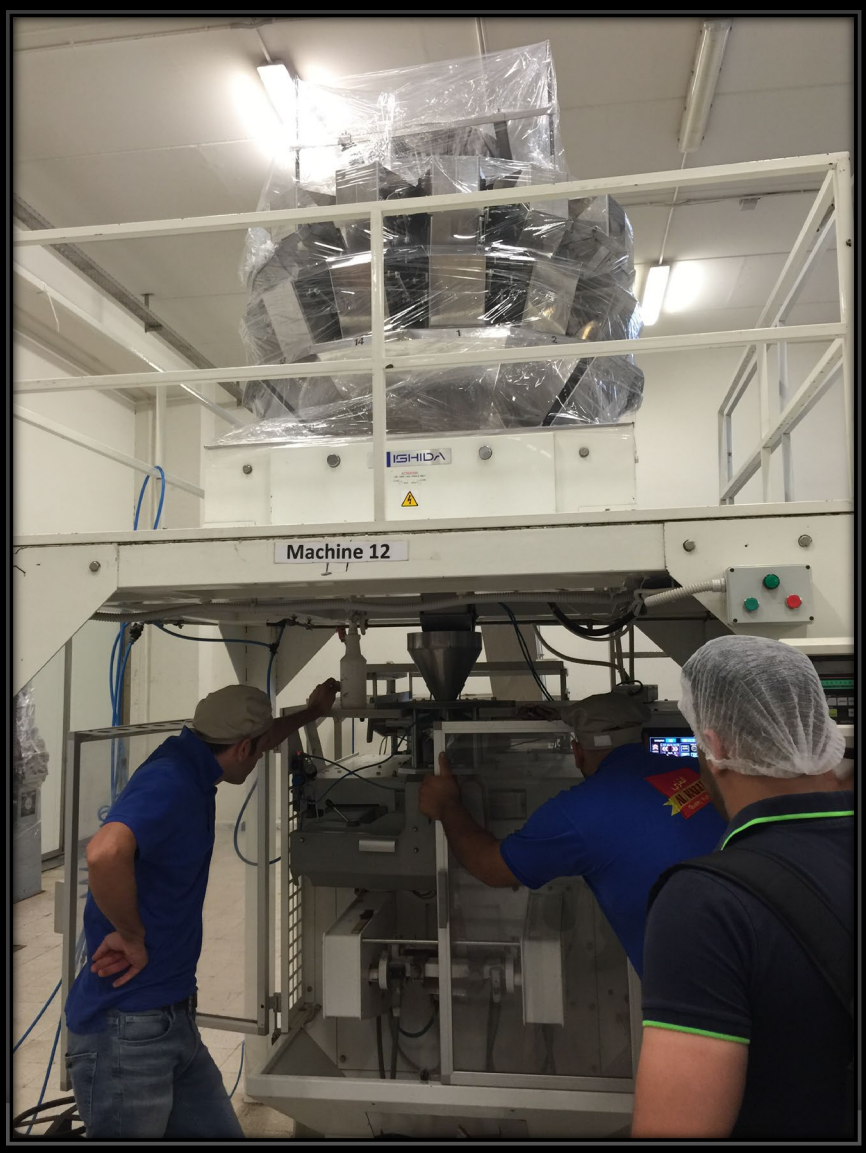

# PLASTIC INJECTION MACHINE



# CONSTANT WATER PRESSURE CONTROL SYSTEM USING PLC & VFD



PID CONTROL





# Our VFD units at Sicomo Paper recycling plant



# Our VFD units at Pharmaline, Four 160kW Air Conditioning chiller compressors.

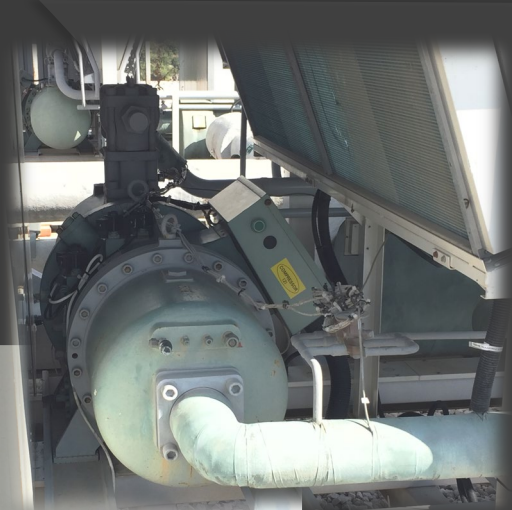

# SOLAR WATER PUMPING 80HP

East Beqaa

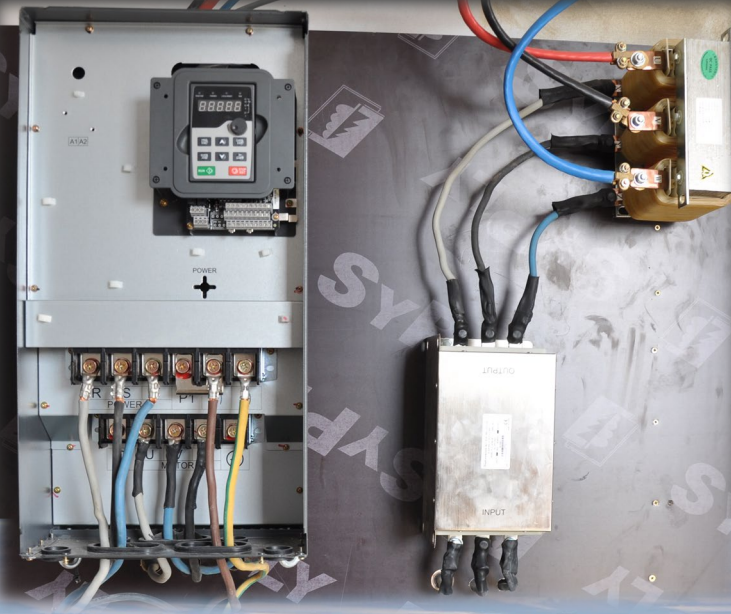
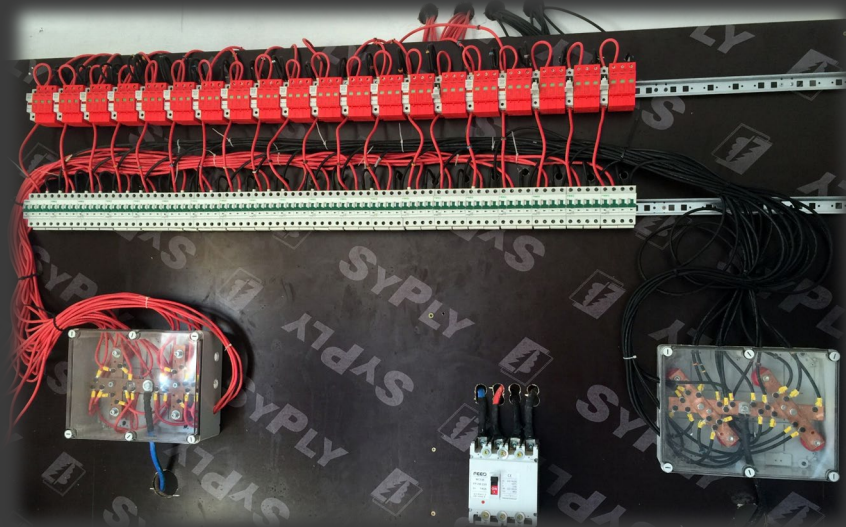

Solar VFD



100kW Array



Distribution

# SOLAR TRACKING SYSTEM 3.6KW



Residential solar system with PV tracker



**N. MICRO**

**S.A.R.L.**

Meeting & Serving the needs of OEMs in Lebanon & the region since 1996.

**Address #1**

Dora Highway, Dedeyan Center,  
Block A, Ground Floor,  
Beirut, Lebanon  
Tel: +961-1-260404  
Fax: +961-1-260405

Email: [info@narincomicro.com](mailto:info@narincomicro.com)

**Address #2**

Zahle Industrial City,  
Main Road - Naddaf Project No. 2  
Tel: +961-70-687200  
Tel: +961-8-931848

**Address #3**

Rmeil, Mar Mikhael,  
Armenia Street,  
Tel: +961-1-443560  
Fax: +961-1-563720