

Micro Human Machine Interface

XGT Panel

Next Generation Micro HMI with Various Displays



Automation Equipment





HMI Innovation!

Minimum-sized XGT Panel

Programming Innovation

Due to full-featured GUI programming tool, anybody can configure a system easily.

Low-Cost Innovation

LSIS know-how-driven high functions reinforce your cost-competitiveness with economic HMI.

Performance Innovation

High functions and reliability beyond the limit of general compact-sized HMIs can realize system operation at its maximum

When you use **XGT Panel**, you are to experience the followings:

Wire Reduction

Replacing complicated wiring by communication line, it is a lot easier to do maintenance work.

Control Panel Downsizing

Thanks to XGT Panel functioning data display, input, output switch and lamp, control panel downsizing is accomplished.

Cost Down

Since I/Os and analog signals are managed by communication, PLC modules and other related equipment would be needless.

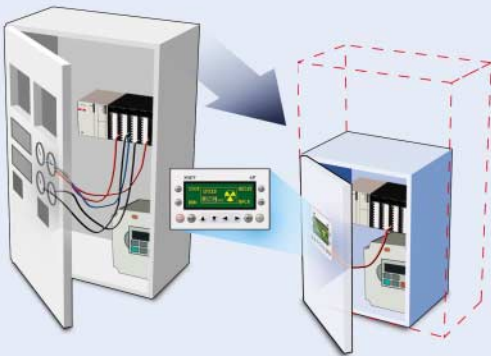

Enhancing User-friendliness

- Flexible to draw: 192 X 64 Dot Graphic LCD
- Easy to upgrade: O/S and font download
- Various tag/drawing functions support: 15 types
- Easy to manage data: internal memory (1000 words) support
- User-defined function keys support for each screen (F1~F4, ◀, ▶, ▲, ▼)
- User-defined bitmap file input support
- Region-based upload/download support
- Built-in RTC: B Type
- Large screen memory: 256K

Flexible to supply power

- 5V supply by loader port for LS PLC and INV connection
- DC 24V supply from DC 24V input terminal

Language support

- English, Chinese, Korean
- Font-download adoption support

Strong communication functions

- Separate 2Ch support: RS-232C and RS-422/485
- Multi master communication (N:M) support
 - Monitoring M PLCs with N GLOFA PANELs

Handy Monitoring Function

Thanks to 5V power supply through the loader port (LS PLC and LS VFD within 2 meters), XGT Panel runs without external DC24V. XGT Panel is portable and easy to configure and maintain.

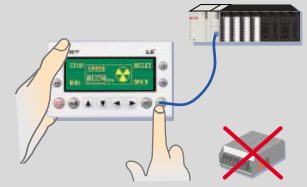

Long-life backlight LED adoption

Low current consumption of LED backlight enables no need of backlight exchange, lengthening product life and convenient maintenance (It would be susceptible to installing conditions and environment).

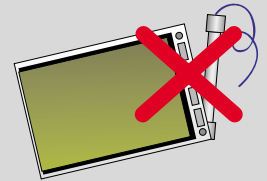

Various communication modes and protocol driver supply

- LS PLC: loader and link (Cnet)
- LS VFD: loader (iS5/iP5(A)/iV5) and RS-485
- MODBUS ASCII/RTU protocol
- Mitsubishi FX series
- OMRON C-mode protocol

* Communication drivers are added and updated.



neXt
Generation
Technology

One step upgraded system with XGT Panel enhances your competitiveness.

System Functions

1:1 configuration

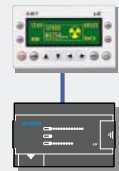

Basic 1:1 configuration using RS-232C/RS-422/485

Application System

Unit Equipment



Used in textile, packaging, injection machines

Main Functions XGT Panel



Digit Tag

Data input and display

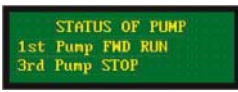

Message Display Tag

Changeable message display for each device value



Lamp Tag

Lamp display (circle and square)



Graph Tag

Variable graph display such as bar, trend, and pie graph.



Rotate/Move Tag

Dynamic expression of object according to device value



BITMAP Display

Easy registration and display of bitmap file in 192 × 64 (max.)



Alarm Record Management

Immediate alarm display concerning system errors (history record: up to 20)



Reservation

Using RTC functions, taking a certain action according to designated time (schedule: up to 20)

Appearance and Functions XGT Panel

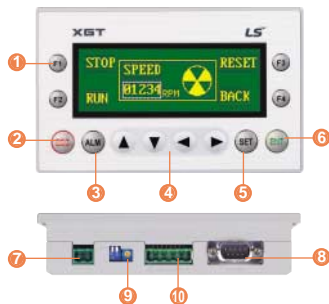

- ① Function keys: Bit/Drive Out/Increment/Decrement/Screen
- ② ESC: Input Cancelling
- ③ ALM: Alarm History
- ④ Arrow Keys: Bit/Drive Out/Increment/Decrement/Screen
- ⑤ SET: PLC Data Input Set-up
- ⑥ ENT: PLC Data Input ENTER
- ⑦ DC24V Power Supply
- ⑧ RS-232C port for downloading/communication
- ⑨ Screen Luminance Adjustment Set-up
- ⑩ RS-422 Port

Easy Drawing Tool Panel Editor



- **Drawing Tool**
Enhanced user-friendliness by diverse drawing functions (line, circle, square, etc)
- **Simple Memory Management**
Easy recognition of the current memory usage

- **Easy Programming**
One click on tag for instant drawing and editing
- **Print Function**
Each screen print function support: available from version 1.1
- **Direct Device Input**
Directly inputting device name
- **Snap/Align functions**
Enhanced drawing easiness: snag and align functions

1:2 or 1:N configuration

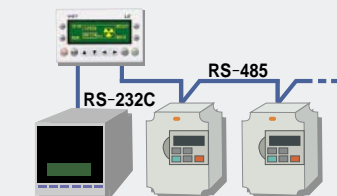

1:2 or 1:N configuration (separate channel): Using two separate communication ports

N:1 configuration

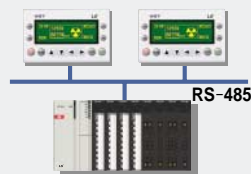

Thanks to multi-master function, XGT Panels can control and supervise one single system.

N:M configuration

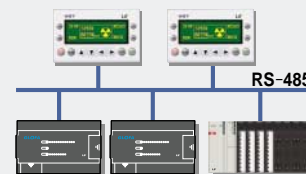

XGT Panels can control different devices of which protocol is equal.

VFD Loader



Used as graphic loader. Regarding LSIS VFD connection, an extra loader cable will do within 2 meters.

Building Automation Equipment



Used to monitor/control data in automatic parking system, HVAC, elevators, etc.

Process Automation

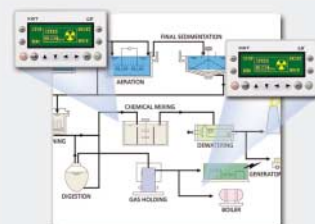

Used to configure a supervisory system (water treatment).

Specifications

Performance specifications

Item	Specifications		Remark
	XP10BKA/DC	XP10BKB/DC	
Input power	4.9~5.1VDC (RS-232C connector), 21.6V~26.4VDC (Power supply connector)		
Display	LED Back-light (192 × 64 Dot)		
Communication Interface	RS-232C, RS-422/485		Separate 2 channels
Memory	256K		
Languages	English, Chinese, Korean		
RTC	None	Supports	
Up/Download spec.	Speed 115,200bps Each memory area can be up/downloaded in part		
Keys	12keys (F1~F4, ESC, ALM, ▲, ▼, ◀, ▶, SET, ENT)		
System memory	User area	M000-M899 (900 words)	Latch area is supported, in XP10BKB/DC
	System flags	M900-M999 (100 words)	

Cable connection for program downloading

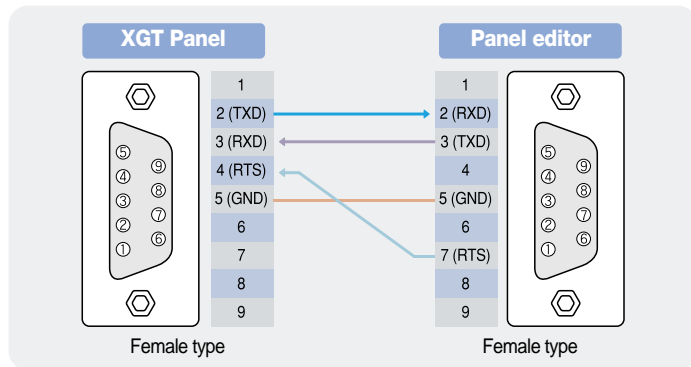

General specifications

Item	Specifications	Standard	
Operating temperature	0°C ~+40°C (32°F ~104°F)		
Storage temperature	-10°C ~+50°C (14°F ~122°F)		
Operating humidity	5~95%RH, non-condensing		
Storage humidity	5~95%RH, non-condensing		
Vibration	Occasional vibration		10 times in each direction for X, Y, Z IEC61131-2
	Frequency	Acceleration Amplitude	
	10 ≤ f < 57Hz	- 0.075mm	
	57 ≤ f ≤ 150Hz	9.8m/s² -	
	Continuous vibration		
Frequency	Acceleration Amplitude		
10 ≤ f < 57Hz	- 0.0375mm		
57 ≤ f ≤ 150Hz	4.9m/s² -		
Shocks	Maximum shock acceleration: 147m/s² (15G) Duration time: 11ms Pulse wave: half sine wave pulse		IEC61131-2
Noise immunity	Square wave impulse noise	±500V	LSIS Standard
	Electrostatic discharge	Voltage: 4kV (contact discharge)	IEC61131-2, IEC1000-4-2
	Radiated electromagnetic field	27~500MHz, 10V/m	IEC61131-2, IEC1000-4-3
	Fast transient /Burst noise	Voltage: 1kV/0.25kV	IEC61131-2, IEC1000-4-4
Atmosphere	Free from corrosive gases and excessive dust		
Altitude for use	Up to 2,000m		
Pollution degree	2 or lower		
Cooling method	Air-cooling		

Line-up

Part number	Specifications
XP10BKA/DC	4.1", Mono, RS-232C, RS-422/485
XP10BKB/DC	4.1", Mono, RS-232C, RS-422/485, RTC

Communication drivers to support

Item	Device	Driver		
LS	PLC	MASTER-K	LOADER	LINK (CNET)
		GLOFA-GM	LOADER	LINK (CNET)
	INV	SV-IC5	-	MODBUS
		SV-IG5/IG5A	-	RS-485, MODBUS
		SV-IS5	LOADER	RS-485, MODBUS
		SV-IP5/IP5A	LOADER	RS-485, MODBUS
SV-IV5	LOADER	-		
SV-IH	-	RS-485		

Others	MITSUBISHI FX Series		
	OMRON C-mode		
MODBUS	Master	RTU	ASC
	Slave	RTU	ASC

* Drivers are continually updated

Dimensions

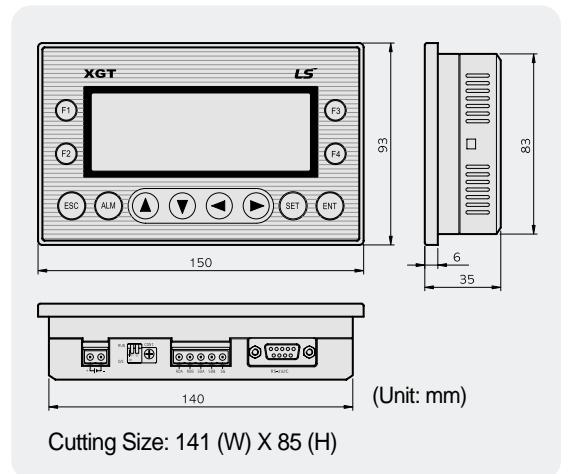

Cable connection

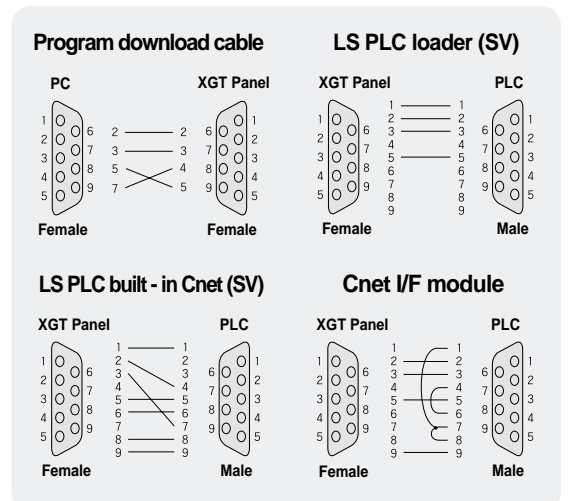

* For more information, refer to user's manual

Leader in Electrics & Automation



Safety Instructions

- For your safety, please read user's manual thoroughly before operating.
- Contact the nearest authorized service facility for examination, repair, or adjustment.
- Please contact qualified service technician when you need maintenance. Do not disassemble or repair by yourself!
- Any maintenance and inspection shall be performed by the personnel having expertise concerned.

© 2004.8 LS Industrial Systems Co.,Ltd. All rights reserved.

LS Industrial Systems Co., Ltd.

www.lsis.biz

■ HEAD OFFICE

Yonsei Jaedan Severance Bldg., 84-11, Namdaemunno 5ga,
Jung-gu, Seoul, 100-753, Korea
Tel. (82-2)2034-4870
Fax. (82-2)2034-4713

■ Global Network

- **LS Industrial Systems (Middle East) FZE >> Dubai, U.A.E.**
Address: P.O.Box-114216, API World Tower, 303B, Sheikh Zayed Road, Dubai, U.A.E.
Tel: 971-4-332-8289 Fax: 971-4-332-9444 e-mail: hwyim@lsis.biz
- **Dalian LS Industrial Systems Co., Ltd. >> Dalian, China**
Address: No.15, Liaohexi 3-Road, Economic and Technical Development zone, Dalian 116600, China
Tel: 86-411-8273-7777 Fax: 86-411-8730-7560 e-mail: lixk@lsis.com.cn
- **LS Industrial Systems (Wuxi) Co., Ltd. >> Wuxi, China**
Address: 102-A, National High & New Tech Industrial Development Area, Wuxi, Jiangsu,214028, P.R.China
Tel: 86-510-8534-6666 Fax: 86-510-522-4078 e-mail: xuhg@lsis.com.cn
- **LS-VINA Industrial Systems Co., Ltd. >> Hanoi, Vietnam**
Address: Nguyen Khe - Dong Anh - Ha Noi - Viet Nam
Tel: 84-4-882-0222 Fax: 84-4-882-0220 e-mail: srjo@lsisvina.com
- **LS Industrial Systems Tokyo Office >> Tokyo, Japan**
Address: 16FL, Higashi-Kan, Akasaka Twin Tower 17-22, 2-chome, Akasaka, Minato-ku Tokyo 107-8470, Japan
Tel: 81-3-3582-9128 Fax: 81-3-3582-2667 e-mail: jschuna@lsis.biz
- **LS Industrial Systems Shanghai Office >> Shanghai, China**
Address: Room E-G, 12th Floor Huamin Empire Plaza, No.726, West Yan'an Road Shanghai 200050, P.R. China
Tel: 86-21-5237-9977 (609) Fax: 89-21-5237-7191 e-mail: jinhk@lsis.com.cn
- **LS Industrial Systems Beijing Office >> Beijing, China**
Address: B-Tower 17FL, Beijing Global Trade Center B/D. No.36, BeiSanHuanDong-Lu, DongCheng-District, Beijing 100013, P.R. China
Tel: 86-10-5825-6025,7 Fax: 86-10-5825-6026 e-mail: cuixiaorong@lsis.com.cn
- **LS Industrial Systems Guangzhou Office >> Guangzhou, China**
Address: Room 1403,14F,New Poly Tower,2 Zhongshan Liu Road,Guangzhou, P.R. China
Tel: 86-20-8326-6764 Fax: 86-20-8326-6287 e-mail: linsz@lsis.com.cn
- **LS Industrial Systems Chengdu Office >> Chengdu, China**
Address: 12Floor, Guodong Buiding, No52 Jindun Road Chengdu, 610041, P.R. China
Tel: 86-28-8612-9151 Fax: 86-28-8612-9236 e-mail: yangcf@lsis.com.cn
- **LS Industrial Systems Qingdao Office >> Qingdao, China**
Address: 7B40,Haixin Guangchang Sheny Building B, No.9, Shandong Road Qingdao 26600, P.R. China
Tel: 86-532-8501-6568 Fax: 86-532-583-3793 e-mail: lirj@lsis.com.cn

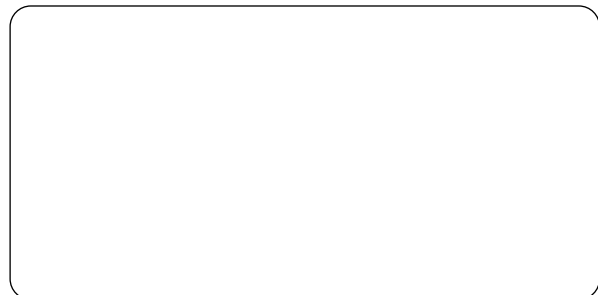

Specifications in this catalog are subject to change without notice due to continuous product development and improvement.